

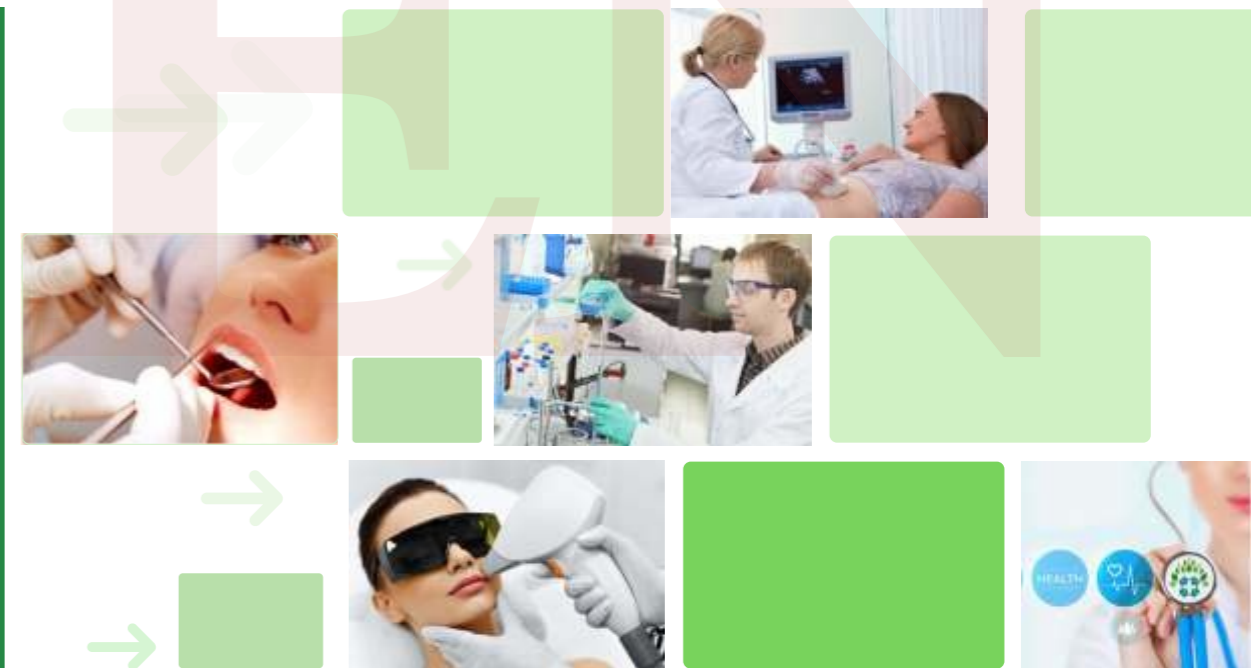



HOSPITAL Product Catalog



NUWEN CO.,LTD

Add: Unit 1, no.187, Xiayang road, Hetang Town Pengjiang, District Jiangmen City, Guangdong, Province, China.

 E-mail: nuwen.china.2020@gmail.com

 Mobile: +86-18680577977

 WeChat/Whats app: +86-18680577977



NUWEN CO.,LTD



Model : DP-10
Portable B/W Ultrasound



Model : DP-20
B/W Ultrasound



Model : DP-2200
Ultrasound Scanner



Model : DP-30
Portable Ultrasound



Model : TE7
Trolley Ultrasound



Model : Z6
Portable Ultrasound



Model : DC-3
Trolley doppler ultrasound



Model : DC-77
Trolley 3D/4D ultrasound



Model : DP-50
Portable Ultrasound



Model : DP-5T
Trolley color ultrasound



Model : M9
Portable color Doppler ultrasound



Model : DC-7
Trolley doppler ultrasound



Model : DC-8
Trolley 4D doppler ultrasound



Model : DC-8-PRO
Trolley doppler ultrasound



Model : DC-77
Trolley 3D/4D ultrasound



Model : DP-7T
Trolley B/W ultrasound



Model : DP-7700
Trolley B/W ultrasounde



Model : DC-30
Trolley ultrasound system



Model : DC-60
Trolley ultrasound system



Model : DC-70
Trolley ultrasound system



Model : DC-70-PRO
Trolley ultrasound system



Model : M5
Portable ultrasound system

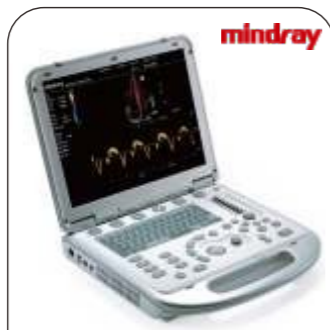

Model : M7Expert
Portable ultrasound system

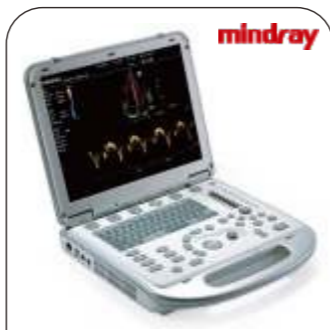

Model : M7
Portable ultrasound system

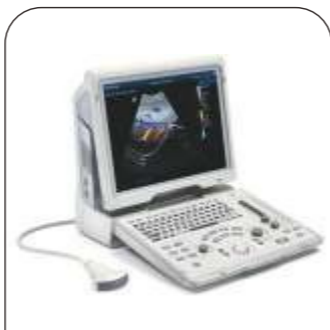

Model : Z5
Portable ultrasound system



Model : DC-N2
Trolley ultrasound system



Model : DC-N3
Trolley ultrasound system



Model : DC-N6
Trolley ultrasound system



Model : R7
Trolley ultrasound system

Ultrasound Room

Ultrasound Room



Model : A5
Portable B/W Ultrasound



Model : A6
Portable B/W Ultrasound



Model : A8
Trolley B/W Ultrasound



Model : X5
Portable Doppler ultrasound



Model : ECO 1
Portable ultrasound scanner



Model : ECO 2
Portable ultrasound scanner



Model : ECO 3
Portable ultrasound scanner



Model : ECO 5
Portable color doppler ultrasound

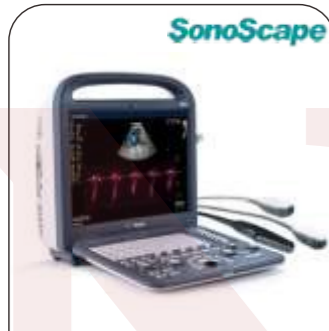

Model : S2
Portable color Doppler ultrasound



Model : S6
Portable color Doppler ultrasound



Model : S8
Portable color Doppler ultrasound



Model : S8 Exp
Portable color Doppler ultrasound



Model : ECO 6
Portable color ultrasound



Model : Ebit 50
Portable color ultrasound



Model : Ebit 60
Portable color ultrasound



Model : I8
Trolley ultrasound machine



Model : S9
Portable color Doppler ultrasound



Model : S11
Trolley color Doppler ultrasound



Model : S12
Trolley color Doppler ultrasound



Model : S50
Trolley color Doppler ultrasound



Model : I3
4D Trolley Ultrasound



Model : Q5
Portable 4D ultrasound

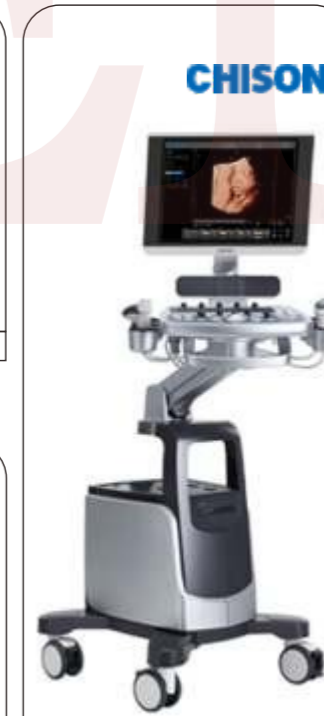

Model : Qbit 7
Trolley ultrasound machine



Model : Qbit 9
Trolley ultrasound machine



Model : S22
Trolley color Doppler ultrasound



Model : S30
Trolley color Doppler ultrasound



Model : S40
Trolley color Doppler ultrasound



Model : Q9
Portable ultrasound scanner



Model : Qbit 5
Trolley ultrasound machine

Ultrasound Room

Ultrasound Room



Model : MSLPU01
Portable Ultrasound Scanner



Model : MSLPU04
Portable Ultrasound Scanner

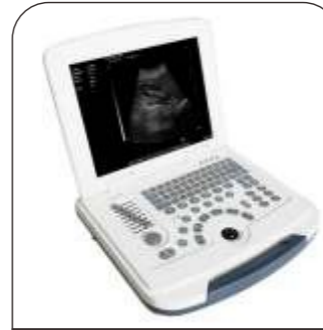

Model : MSLPU09
Laptop ultrasound machine



Model : MSLPU15
Ultrasound Box



Model : MSLPU46
Portable Ultrasound Scanner



Model : MSLPU47
Wifi transvaginal Probe



Model : MSLPU48
Wifi micro-convex Probe



Model : MSLMU01
Wifi Convex Probe color doppler



Model : MSLPU24
15 inch ultrasound



Model : MSLPU25
Portable 3D Ultrasound



Model : MSLPU26
Laptop ultrasound



Model : MSLPU27
Portable Ultrasound system



Model : MSLMU02
Wifi Linear Probe 7.5 MHz



Model : MSLPU40
Wifi Convex Probe 128 elements



Model : MSLPU41
Wifi Linear Probe 7.5 MHz



Model : MSLPU42
Wifi Super Linear Probe 10.0MHz



Model : MSLPU28
Laptop ultrasound machine



Model : MSLPU30
Portable 3D Ultrasound



Model : MSLPU32
Handheld ultrasound



Model : MSLPU33
Portable Ultrasound system



Model : MSLPU2
Wifi Convex Probe



Model : MSLPU3
Wifi Linear Probe



Model : MSLPU6
Wifi transvaginal Probe



Model : MSLTU01
Trolley B/W ultrasound



Model : MSLPU36
Wireless Vet probe



Model : MSLPU39
USB Convex probe



Model : MSLPU44
Laptop ultrasound machine



Model : MSLPU45
Portable Ultrasound system



Model : MSLTU02
Trolley B/W ultrasound



Model : MSLTU04
Trolley color Doppler ultrasound



Model : MSLTU04 Plus
Trolley B/W ultrasound



Model : MSLTU05
Trolley B/W ultrasound

Ultrasound Room

Ultrasound Room

Ultrasound Room

Ultrasound Room



Model : MSLCU88
Wifi color Doppler Convex Probe



Model : MSLCU89
Wifi color Doppler Linear Probe



Model: MSLVU15
Handheld Vet Ultrasound



Model: MSLVU18
Portable Vet Ultrasound



Model: MSLVU19
Handheld Vet Ultrasound



Model: MSLVU21
Handheld Vet Ultrasound



Model: MSLVU22
Handheld Vet Ultrasound system



Model: MSLVU23
Handheld Ultrasound



Model: MSLCU11
Portable 3D Doppler ultrasound



Model : MSLCU12
Portable color Doppler ultrasound



Model : MSLPU16
Bladder Scanner



Model: MSLPU17
Bladder Scanner



Model: MSLPU37
4D Wifi Bladder Scanner



Model : MSLPU43
Bladder Scanner



Model : MSLCU17
3D B/W ultrasound



Model : MSLCU18
4D Ultrasound Machine



Model : MSLCU23
Portable Color Doppler ultrasound



Model : MSLCU25
Handheld Color Doppler System



Model : MSLPU21
Ophthalmology Ultrasound



Model : MSLPU22
Ophthalmology Ultrasound



Model : MSLPU23
Ophthalmology Ultrasound

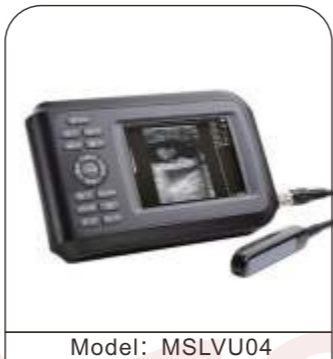

Model: MSLVU04
Vet Ultrasound System

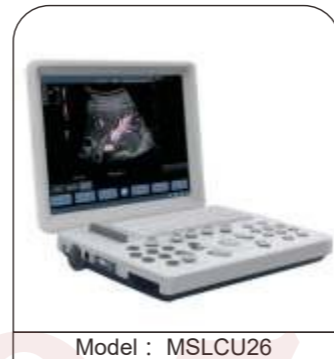

Model : MSLCU26
Portable color Doppler ultrasound



Model : MDLCU28
Portable color Doppler ultrasound



Model : MSLCU28Plus
Portable color Doppler ultrasound



Model : MSLCU29
Touch Screen Ultrasound System

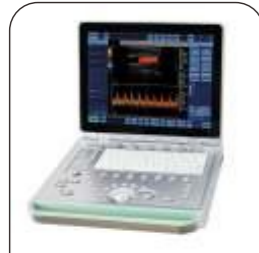

Model : MSLCU31
Portable color Doppler ultrasound



Model : MSLCU32
Portable color Doppler ultrasound



Model : MSLPU49
Portable Ultrasound Scanner



Model : MSLCU36
color laptop ultrasound



Model : MSLCU42
Portable color laptop ultrasound



Model : MSL200D
Handheld Fetal Doppler



Model : MSL520
Vascular Doppler



Model : MSL520T
Vascular Doppler

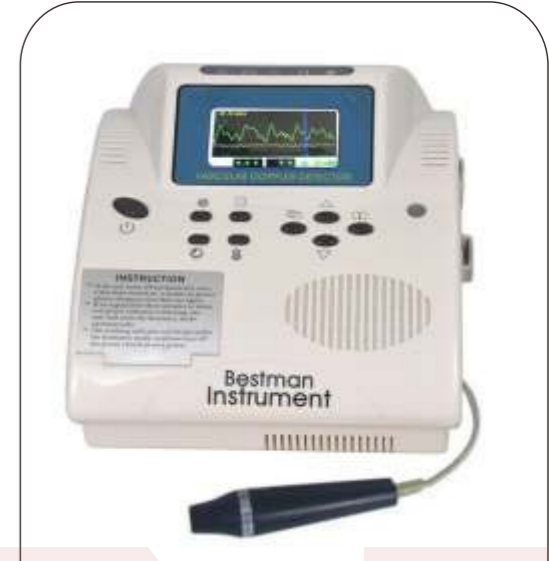

Model : MSL620V
Vascular Doppler



Model : MSLCU42 Plus
color laptop ultrasound



Model : MSLCU43
Handheld color Ultrasound



Model : MSLCU45
color laptop ultrasound



Model : MSLTU06
Trolley B/W ultrasound



Model : MSL650V
Vascular Doppler



Model : Style-A
Ultrasound Trolley



Model : Style-B
Ultrasound Trolley



Model : MSLCU46
Trolley color ultrasound



Model : MSLCU47
Trolley color ultrasound



Model : MSLCU48
Trolley color ultrasound



Model : Style-C
Ultrasound Trolley



Model : Glass A
Video glasses



Model : Glass B
Video glasses



Model : P93C
Thermal Printer



Model : Sony upx 898M
Sony Printer



Model : MSLCU49
color laptop ultrasound



Model : MSLCU24
Trolley color ultrasound



Model : MSLCU30
Trolley color ultrasound



Model : MSLCU30 Plus
Trolley color ultrasound



Model : MSLBSB
Fetal Doppler



Model : up-25MD
Sony Printer



Model : Sony up 110 S
Sony 110S



Model : Sony up 110 HG
Sony 110HG



Model : 250mL
Ultrasound gel



Model : 2.5L
Ultrasound gel



Model : MSLDSA
Fetal Doppler



Model : MSLDSB
Fetal Doppler



Model : MSLDSB
Fetal Doppler



Model : MSL200B
Fetal Doppler



Model : MSL200C
Fetal Doppler



Model : MSL1501
Gel warmer



Model : MSL1502
Gel warmer



Model : MSLT1
Gel warmer



Model : MSLT2
Gel warmer



Model : MSLT3
Gel warmer

Ultrasound Room

Ultrasound Room



Model : BC-2800
Mindray Hematology Analyzer



Model : BC-20C
Mindray Hematology Analyzer



Model : MSLAB07
Vet Hematology Analyzer



Model : MSLAB07PLUS
Full Automatic Hematology Analyzer



Model : MSLBA11
Semi-Auto Chemistry Analyzer



Model : MSLBA15
Biochemical Analyzer



Model : MSLBA21
Chemistry Analyzer



Model : MSLBA22
Chemistry Analyzer



Model : MSLAB20
5 Diff Hematology Analyzer



Model : MSLAB21
Touch Screen Hematology Analyzer



Model : MSLAB21Plus
Lab Hematology Analyzer



Model : MSLAB22
Automatic Hematology



Model : MSLBA50
Biochemical Analyzer



Model : MSLDA01
Biochemical Analyzer



Model : MSLBA10
Full Auto Chemistry Analyzer



Model : MSLBA23
Full Auto Chemistry Analyzer



Model : MSLAB23
5 Diff Hematology Analyzer



Model : MSLAB24
5 Diff Hematology Analyzer



Model : MSLAB28
5 Diff Hematology Analyzer



Model : MSLAB11
5 Diff Vet Hematology Analyzer



Model : MSLBA23Plus
Auto Biochemistry



Model : MSLABI02
Full Auto Chemistry Analyzer



Model : MSLBA28
Full Auto Chemistry Analyzer



Model : MSLBA29
Full Auto Chemistry Analyzer



Model : M800
Chemiluminescence Analyzer



Model : MSLBA05
Biochemistry Analyzer



Model : BA-88A
Mindray Biochemistry Analyzer



Model : MSL06Plus
Semi-Auto Chemistry Analyzer



Model : MSLBA09
Semi-Auto Chemistry Analyzer



Model : MSLBA30
Auto Biochemistry Analyzer



Model : MSLABI01
Portable Auto Chemistry Analyzer



Model : MSLBA53
Full Auto Chemistry Analyzer



Model : MSLBA12
Coagulometer Dual channel



Model : MSLBA13
Coagulometer single channel



Model : MSLBA18
Coagulometer four channel



Model : MSLBA26
Lab Coagulometer



Model : MSLCM04
Immunoassay Analyzer



Model : MSLCM05
Immunoassay Analyzer



Model : MSLCM06
Immunoassay Analyzer



Model : MSLUA02V
Handheld Urine Analyzer



Model : MSLBA33
Automatic Coagulometer



Model : MSLBA35
Automatic Coagulometer



Model : MSLAB17
Blood Gas Analyzer



Model : MSLAB18
Blood Gas Analyzer



Model : MSLUA13
Auto Urine Analyzer



Model : MSLUA04
Urine Analyzer



Model : MSLUA05-1
Urine Analyzer



Model : MSLUA14
Urine Analyzer



Model : MSLEA01
Electrolyte Analyzer



Model : MSLEA02
Electrolyte Analyzer



Model : MSLEA03
Electrolyte Analyzer



Model : MSLER01
Microplate Reader



Model : MSLUA16
Urine Analyzer



Model : MSLDJ02
Auto Urinary Sediment Analyzer

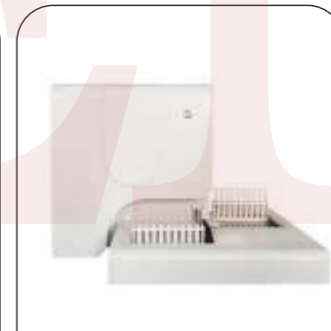

Model : MSLDJ01
Auto Urinary Sediment Analyzer



Model : MSL LX30
Auto Urinary Sediment Analyzer



Model : MSLER02
Microplate washer



Model : MSLER03
Microplate Reader



Model : MSLER05
Microplate Reader



Model : MSLER06
Microplate Reader



Model : MSLKN01
UV phototherapy



Model : MSLKN05
UV phototherapy



Model : MSLKN03
UV phototherapy



Model : MSLKN06
UV phototherapy



Model : MSLKN04
UV phototherapy



Model : MSLYK01
UV Radiation System



Model : MSLFA10
Electronic Balance

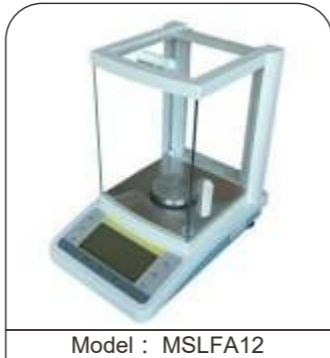

Model : MSLFA12
Electronic Balance



Model : MSLZL09
Centrifuge



Model : MSLZL16
Low speed centrifuge



Model : MSLDZ100
Mini Centrifuge



Model : MSLDZ300
High Speed Micro-Centrifuge



Model : MSLYK10
Electronic Balance



Model : MSLPCR01
Thermal cycler for PCR



Model : MSLPCR02
PCR Detection System



Model : MSLPCR03
PCR Detection System



Model : MSLDZ600
Clinical Centrifuge



Model : MSLDZ400plus
Clinical Centrifuge



Model : MSLHC01
High Speed Centrifuge



Model : MSLHC02
Refrigerated Centrifuge



Model : MSLFD01
Portable ATP



Model : MSLFD02
Portable ATP System



Model : MSLPUC-A
ESR analyser



Model : MSLXC01
ESR analyser



Model : MSLHC03
Refrigerated Centrifuge



Model : MSLDZ700
Clinical Centrifuge



Model : MSLHC05
Table Refrigerated Centrifuge



Model : MSLDC04
Low Speed Centrifuge



Model : MSLXC02
ESR analyser



Model : MSLZL01
Handheld Centrifuge



Model : MSLZL02
Micro centrifuge



Model : MSLZL07
Centrifuge



Model : MSLNC01
Low Speed Centrifuge



Model : MSLHC04
High Speed Centrifuge



Model : MSLDC01
Low Speed Centrifuge



Model : MSLTC02
Low Speed Centrifuge



Model : MSLYZ02
LED Fluorescencece Microscope



Model : MSL45T1
Trinocular Microscope



Model : MSLYZ01
LED Fluorescencece Microscope



Model : MSLPL2A
Binocular Microscope



Model : MSLIPL3B
Trinocular Microscope

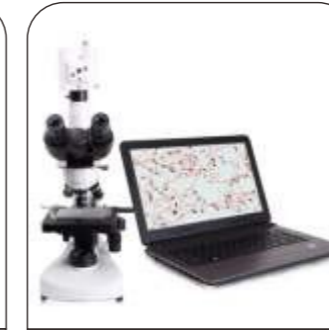

Model: MSL68P
Sperm Analyzer



Model: MSL68T
Sperm Analyzer



Model: MSL3704
Sperm Analyzer



Model : MSL-52
Binocular Microscope



Model : MSL-500T
Trinocular Microscope



Model : MSLPH50
Trinocular Microscope



Model : MSLPH100
Trinocular Microscope



Model: MSL3702
Sperm Analyzer



Model: MSLGC01
Glucometer



Model : MSLYZ15
Glucometer



Model : MSLYZ16
Glucometer



Model : MSLZJ022
Single Microscope



Model : MSLZJ023
Single Microscope



Model: MSL45T2
Binocular microscope



Model: MSL45T3
Trinocular Microscope



Model : MSLGC05
Glucometer

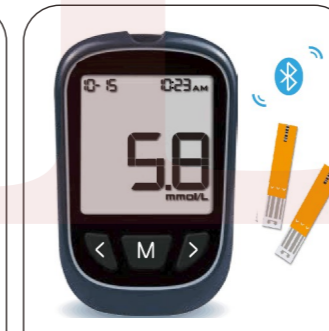

Model : MSLGC06
Glucometer



Model : MSLBX02
-25°C deep freezer



Model : MSLBX03
deep freezer



Model : MSLZJ025
Single Microscope



Model : MSLIPL2B
Binocular Microscope



Model : MSLPL3A
Trinocular Microscope



Model: MSL45T4
Trinocular Microscope



Model : MSL120
120L Fridgerator



Model : MSLBX01
2-8°C Medical Fridgerator



Model : MSLBX04
400L Fridgerator



Model : MSLBX05
288L Fridgerator



Model : MSLBX06
Blood Tank Fridgerator



Model : MSLBX07
Blood Tank Fridgerator



Model : MSLBX08
300L Fridgerator



Model : MSLBX09
Blood Tank Fridgerator



Model : MSLPS15
Handheld Sterilizer



Model : MSLPS17
Handheld Sterilizer



Model : MSLPS18
Handheld Sterilizer



Model : MSLPS07
Vertical Sterilizer



Model : MSLBX10
Low Temperature Fridgerator



Model : MSLBX11
Low Temperature Fridgerator



Model : MSL1200
Reagent Fridgerator



Model : MSLMRF01
Portable Fridgerator



Model : MSLPS10
Vertical Sterilizer



Model : MSLPS20
Benchtop Sterilizer



Model : MSLPS08
Vertical Sterilizer



Model : MSLPS09
Vertical Sterilizer



Model : MSLCP01
Car mini fridge



Model : MSLCP02
Car mini fridge



Model : MSLPS03
18L Sterilizer



Model : MSLPS01
18L Sterilizer



Model : MSLPS06
Vertical Sterilizer



Model : MSLPS29
Benchtop Sterilizer



Model : MSLPS12
Vertical Sterilizer



Model : MSLPS11
Vertical Sterilizer



Model : MSLSS02
Automatic Sterilizer



Model : MSLPS26
Handheld Sterilizer



Model : MSLPS13
Handheld Sterilizer



Model : MSLPS14
Handheld Sterilizer



Model : MSLPS19
Horizontal Sterilizer



Model : MSLPS31
Horizontal Sterilizer



Model : MSLPS21
Benchtop Sterilizer



Model : MSLPS33
Benchtop Sterilizer



Model : MSLPS24
Horizontal Sterilizer



Model : MSLPS23
Horizontal Sterilizer



Model : MSLPS34
Horizontal Sterilizer



Model : MSLPS28
Water distilling machine



Model : MSLOS30
Mechanical Heating Stirrer



Model : MSLOS31
Mechanical Heating Stirrer



Model : MSLOS28
Multi-in-one Stirrer



Model : MSL-1000IIB2
10%Exhaust Safety Cabinet



Model : MSLPS25
Water distilling machine



Model : MSLPS27
Water distilling machine



Model : MSLTA01
8L. Autoclave



Model : MSLOS04
Digital Shaker



Model : MSL-1300IIA2
30%Exhaust
Biological Safety Cabinet



Model : MSL-TF13
Fume Hood



Model : MSL-1000IIA2
30%Exhaust Safety Cabinet



Model : MSL-TF06
Fume Hood



Model : MSLOS05
Orbital Shaker



Model : MSLOS07
Digital Orbital Shaker



Model : MSLOS09
Vortex mixer



Model : MSLOS10
Blood mixer



Model : MSLVD850
Vertical Laminar Flow



Model : MSLCJ2D
Vertical Laminar Flow



Model : MSL-TF14
Desktop Fume Hood



Model : MSL-TF12
Fume Hood



Model : MSLOS11
Blood mixer



Model : MSLOS18
Speed electric stirrer



Model : MSLOS24
Mechanical stirrer



Model : MSLOS21
Mechanical stirrer



Model : MSL-TF15L
Fume Hood



Model : MSLDB02
Drying Oven 70L



Model : MSLDB04
Oven/Incubator



Model : MSLDF01
Vacuum incubator



Model : MSLDF03
Trolley Vacuum incubator



Model : MSldb01
Drying Oven 25L



Model : MSllB01
Lab Bench



Model : MSllB02
Lab Bench



Model : MSlnL03
3D-NLS health analyzer



Model : MSlnL05
9D-NLS health analyzer



Model : MSLHQ403
Quantum Analyzer 4th generation



Model : MSL10L
Purified water machine 10L



Model : MSLBC01
Blood Cell Counter



Model : MSLUV02
Vis spectrophotometer



Model : MSLUV03
UV spectrophotometer



Model : MSLUV08
Vis spectrophotometer



Model : MSL50L
Purified water machine 50L



Model : MSL100L
Purified water machine 100L



Model : MSCLCT01
cholesterol Meter



Model : MSLGH05
Hemoglobin meter



Model : MSLUV01
Vis spectrophotometer



Model : MSLUV12
UV spectrophotometer



Model : MSLUV11
UV spectrophotometer



Model : MSlnL04
9D-NLS health analyzer



Model : MSLGH01
Specific Protein Analyzer



Model : MSLGH03
Specific Protein Analyzer



Model : MSLGH04
Automatic CRP system



Model : MSLGH06
Hemoglobin meter



Model : MSLHQ313
Quantum analyzer 3rd generation



Model : MSLHQ301
Quantum analyzer



Model : MSlnL01
3D-NLS health analyzer



Model : MSlnL02
3D-NLS health analyzer



Model : MSZJ012
Water jacket incubator



Model : MSZJ001
Co² incubator



Model : MSZJ003
Heating incubator 15L



Model : MSZJ008
Cultivation incubator



Model : MSLZJ016
Concussion incubator



Model : MSLPI01
Portable incubator 9L



Model : MSLS100
POCT test system



Model : MSLYM01
Spirometer



Model : MSL-268
vein Illuminator



Model : MSL-269
vein finder



Model : MSLIM01
Infrared Inspection for Mammary Gland



Model : MSLIM02
Mastopathy Treatment Apparatus



Model : MSLYM21
Spirometer



Model : MSLYM22
Electronic Spirometer



Model : MSL150W
Ultrasonic Cell Crusher



Model : MSL1200
1200 °C muffle furnace



Model : MSLIM03
Mastopathy Treatment Apparatus



Model : MSLYC11
LED Digital Shaker



Model : MSLYC01
Orbital Shaker



Model : MSLYC03
Linear Shaker



Model : MSL1700
1700 °C muffle furnace



Model : MSLFV01
Vacuum freeze drying



Model : MSLFV02
Vacuum freeze drying



Model : MSLFV03
Vacuum freeze drying



Model : MSLMX04
Tube Roller



Model : MSLMX05
Tube Roller



Model : MSLYC05
3D Digital Shaker



Model : MSLMX01
Vortex Mixer



Model : MSLBM06
Breast milk analyzer



Model : MSLBM01
Breast milk analyzer



Model : MSLBM03
Breast milk analyzer



Model : MSL-267
vein finder



Model : MSLMX08
Digital Rotator



Model : MSLMX09
Digital Rotator



Model : MSLRE100
Rotary Evaporator



Model : MSLMX03
Microplate Mixer



Model : MSLCS1
Magnetic Stirrer



Model : MSLCS4
Magnetic Stirrer



Model : MSLHP05
Magnetic Stirrer



Model : MSLHP09
Magnetic Stirrer



Model : MSLRDT001
Dengue Combo Rapid Test Cassette (Whole Blood-Serum-Plasma)



Model : MSLRDT002
HAV IgG-IgM Combo Rapid Test Cassette (Serum-Plasma)



Model : MSLRDT003
HbsAg Rapid Test Cassette (Whole Blood-Serum-Plasma)



Model : MSLRDT004
HbsAg Rapid Test Dipstick (Whole Blood-Serum-Plasma)



Model : MSLOS20A
Overhead Stirrer



Model : MSLYY01
Pipettes



Model : MSLYY02
Pipettes



Model : MSLYY04
Pipettes



Model : MSLRDT005
HCV Rapid Test Cassette (Whole Blood-Serum-Plasma)



Model : MSLRDT006
HCV Rapid Test Dipstick (Whole Blood-Serum-Plasma)



Model : MSLRDT007
HIV 1.2.0 Rapid Test Cassette (Whole Blood-Serum-Plasma)



Model : MSLRDT008
HIV 1.2.0 Rapid Test Dipstick (Whole Blood-Serum-Plasma)



Model : MSLOS20
Overhead Stirrer



Model : MSLYY07
Pipettes



Model : MSLYY08
Pipettes



Model : MSLYY10
Pipettes



Model : MSLRDT009
Malaria P.f. Pan Rapid Test Cassette (Whole Blood)



Model : MSLRDT010
Syphilis Rapid Test Cassette (Whole Blood-Serum-Plasma)



Model : MSLRDT011
Syphilis Rapid Test Dipstick (Whole Blood-Serum-Plasma)



Model : MSLRDT012
Tuberculosis Rapid Test Cassette (Whole Blood-Serum-Plasma)



Model : MSLYY06
Pipettes



Model : MSLCM100
Thermo Mix



Model : MSLHB120
Dry Bath



Model : MSLTC100
PCR Thermo cycler



Model : MSLRDT013
Tuberculosis Rapid Test Dipstick (Whole Blood-Serum-Plasma)



Model : MSLRDT014
Typhoid Rapid Test Cassette (Whole Blood-Serum-Plasma)



Model : MSLRDT015
Typhoid Rapid Test Dipstick (Whole Blood-Serum-Plasma)



Model : MSLRDT016
hCG Pregnancy Rapid Test Cassette (Urine)



Model : MSLCY02
Double Cryolipolysis Machine



Model : MSLCY03
Multifunctional Slimming Machine



Model : MSLBC05
PRP Centrifuge



Model : MSLBTL01
BIL slimming machine



Model : MSLCM02
Multipolar RF machine



Model : MSLCY01
Cryolipolysis slimming



Model : MSLHF15
Liposonic &Hifu Machine



Model : MSLHF16
Lipohifu Slimming Machine



Model : MSLHF17
Lipohifu Slimming Machine



Model : MSLHF22
Liposonic &Hifu Machine



Model : MSLV9
Velashape Machine



Model : MSLVS03
Velashape Machine



Model : MSLCY05
Fat Freezing Maching



Model : MSLCY06
Lipo Laser RF Machine



Model : MSLCY08
Cryolipolysis Slimming Machine



Model : MSLCY09
Double Cryolipolysis Slimming
Handles Machine



Model : MSLIP01
Infrared Pressotherapy Slimming



Model : MSLLL02
Lipolaser Slimming



Model : MSLUS02
Vacuum Cavitation RF Machine



Model : MSLDL01
Triple Laser Hair Removal



Model : MSLDM05
5 in 1 Cavitation Rff



Model : MSLDM06
Fat Rotating Slimming



Model : MSLHF06
Liposonic Slimming Machine



Model : MSLHF11
Liposonic &Hifu Machine



Model : MSLDL04
Diode Laser Hair Removal



Model : MSLDL05
808nm Diode Laser Hair Removal



Model : MSLDL06
Diode Laser Hair Remova



Model : MSLDL08
laser wavelength
hair removal machine



Model : MSLRF01
RF Diathermy Machine



Model : MSLRF06
Microneedle RF



Model : MSLHR01
IPL Hair Removal Machine



Model : MSLHR02
OPT SHR Machine



Model : MSLHR04
Hair Removal Machine



Model : MSLGO01
OxyGeneo



Model : MSLHF20
3D HIFU



Model : MSLHF21
3D Hifu Machine



Model : MSLMG01
Mesogun



Model : MSLMG02
needle free mesogun



Model : MSLVR01
Spider Vein Removal



Model : MSLHF08
Vaginal tightening



Model : MSLRF03
Thermo lift



Model : MSLRF10
Microneedle RF



Model : MSLCF01
Vaginal Tightening



Model : MSLCF05
Co² laser machine



Model : MSLMG03
needle free mesogun



Model : MSLOX03
Oxygen Facial Machine



Model : MSLPD01
PDT Facial Machine



Model : MSLPD02
PDT Facial Machine



Model : MSLDM03
7in1 dermabrasion



Model : MSLDM04
4in1 hydra facial



Model : MSLHF07
Hifu Machine



Model : MSLHF19
Hifu Machine



Model : MSLHF10
Vaginal tightening machine



Model : MSLHF12
2in1 Hifu machine



Model : MSLC8
C8 laser machine



Model : MSLLO1
3 in 1 OPT Laser RF Machine



Model : MSLDP01
Micro Needle Pen



Model : MSLDP02
Plasma Pen



Model : MSLPL02
Picosure Laser



Model : MSLYL02
Tattoo Removal Machine



Model : MSLSF02
Derma Roller



Model : MSLUS02
Thermage



Model : MSLOX02
oxygen facial machine



Model : MSLHL02
Hair Regrowth machine



Model : MSLST02
Shockwave Therapy



Model : MSLTM-502
EMS Slimming



Model : MSLA1
Micro Needle Pen



Model : MSLDP03
Plasma Pen



Model : MSLAF01
Fat freezing membranes



Model : MSLCC01
carbon cream



Model : MSLDM02
Breast Enhancement



Model : MSLDM02-2
Dermabrasion



Model : MSLDP04
Plasma Pen



Model : MSLMU01
Make-up



Model : MSLPH01
Photon Anti-aging



Model : MSLSF01
Micro Needle Roller



Model : MSLHF02
Hifu Machine



Model : MSLHF03
Liposonix Slimming



Model : MSLSK02
Skin Analyzer



Model : MSLPL01
Picosure Laser



Model : MSLCTX01
16MS Helical CT scanner



Model : MSLCTX02
32MS Helical CT scanner



Model : MSLMRI01
0.3T Permanent MRI



Model : MSLCTX03
64MS Helical CT scanner



Model : MSLMRI02
0.35T Permanent MRI



Model : MSLMRI03
0.5T Permanent MRI

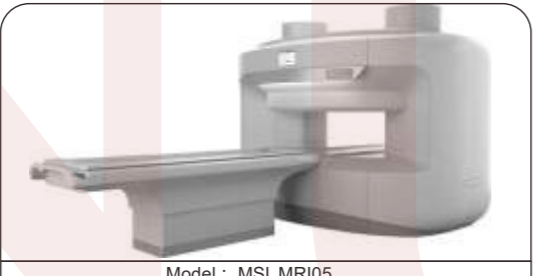

Model : MSLMRI05
0.7T Permanent MRI



Model : MSLMRI06
1.5T Permanent MRI



Model : MSLMRI07
3.0T Permanent MRI



Model : MSLMRI10
1.2T Permanent MRI



Model : MSLMRI11
Single Photon Emission
Computed Tomography (SPECT)



Model : MSLMRI08
0.4T Permanent MRI



Model : MSLMRI09
1.5T Permanent MRI



Model : MSLMRI13
VET MRI



Model : MSLMX10
Mobile X-ray machine (30mAx)



Model : MSLPX11
High Frequency Mobile X-ray
machine (70mA, 3.5KW, 40kHz)



Model : MSLPX17
High Frequency
Mobile X-ray machine



Model : MSLPX05
Portable X-ray Unit



Model : MSLHX06
High Frequency X-ray machine



Model : MSLVX16
Vet use High Frequency
X-ray machine (70mA)



Model : MSLVX17
Vet use High Frequency
X-ray machine (200mA)



Model : MSLVX10
Vet use High Frequency
X-ray machine



Model : MSLMX02
High Frequency Mobile X-ray
machine (100mA, 5KW, 50kHz)



Model : MSLMX08
Mobile X-ray machine (50mAx)



Model : MSLPX06
Portable X-ray Unit



Model : MSLCX40
C Arm High Frequency



Model : MSLCX41
C Arm High Frequency



Model : MSLCX42
C Arm High Frequency



Model : MSLCX44
High Frequency C Arm



Model : MSLCX43
C Arm High Frequency



Model : MSLPX01
Portable High Frequency X-ray Unit



Model : MSLCX34
C Arm High Frequency X-ray
machine (3.5kw, 110kv, 40kHz)



Model : MSLCX36
C Arm Digital High Frequency
X-ray machine (3.5kw, 110kv, 40kHz)



Model : MSLHX14
Digital High Frequency X-Ray



Model : MSLDR01
DR System



Model : MSLHX07
Digital DR System





Model : MSLSB01 Carbon Steel Bracket
 Model : Medical film Medical film
 Model : MSL001A/B Protection lead Apron
 Model : MSL002A/B Protection lead Apron
 Model : MSL003A/B Protection lead Apron



Model : MSLRS01 lead protective gloves
 Model : MSLRS02 lead protective shoes
 Model : MSLRS03 Lead arm cover guard
 Model : MSLRS04 lead protective gloves
 Model : MSLRS05 lead protective collar



Model : MSL004A/B Protection lead Apron
 Model : MSLLA01 Protection lead Apron
 Model : MSLLA02 Protection lead Apron
 Model : MSL009A/B Protection lead Apron
 Model : MSL010A/B Protection lead Apron



Model : MSLRS06 lead cap
 Model : MSLRS07 lead vest
 Model : MSLLS05 Protection lead Hat
 Model : MSLRS09 Lead hat
 Model : MSLRS10 Interventional radiological protection gloves



Model : MSLLA06 Protection lead Apron
 Model : MSLLA07 Protection lead Apron
 Model : MSLLA04 Protection lead Apron
 Model : MSLLA05 Protection lead Apron
 Model : MSLLJ02 Protection lead Apron



Model : MSLRS11 hand protective
 Model : MSLRS12 Lead gloves
 Model : MSLRS13 Protective collar
 Model : MSLRS15 Protective Mask
 Model : MSLRS16 Protective Mask



Model : MSLLS01 Radiation Proof Suit
 Model : MSLLA10 Protection lead Apron
 Model : MSLLA11 Protection lead Apron
 Model : MSLLS03 Lead Triangle
 Model : MSLLS04 Lead Towel



Model : MSLLD01 Lead door
 Model : MSLLD02 single radiation screen
 Model : MSLLD04 three radiation screen
 Model : MSLLD08 double radiation screen
 Model : MSLLG01 lead glass



Model : MSLLS06 Straight collar
 Model : MSLLS07 Square lead towel
 Model : MSLLS08 Children protective towel
 Model : MSLLS09 Triangle protective towel
 Model : MSLLS10 Lead protective underpants

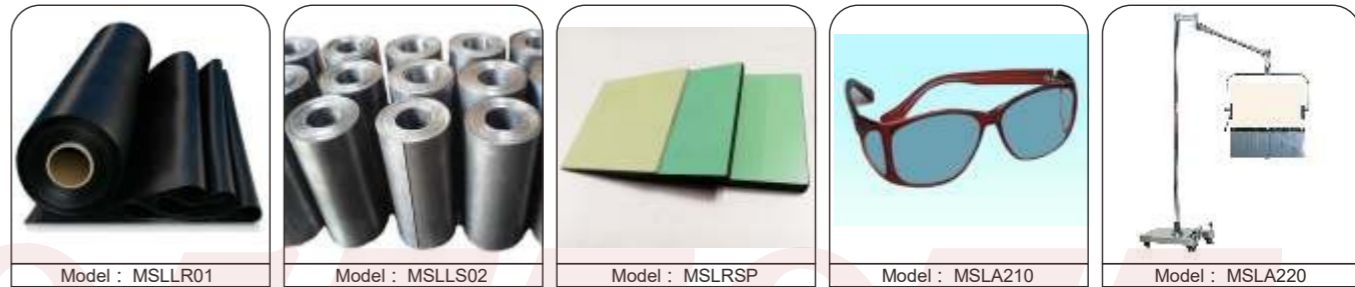

Model : MSLLR01 Lead rubber
 Model : MSLLS02 Lead Sheet
 Model : MSLRSP Lead Free Radiation Shielding Panel
 Model : MSLA210 X-Ray Film Viewer
 Model : MSLA220 X-Ray Film Viewer



Model : MSLDU10

Dental chair



Model : MSLDU11

Dental chair



Model : MSLDU12

Integral dental unit



Model : MSLDU13

Integral dental unit



Model : MSLDU19

Portable dental chair



Model : MSLDU20

Portable dental chair



Model : MSLDU22-1

Folding Chair



Model : MSLDU22-3

Folding Chair



Model : MSLDU14

Separate dental unit

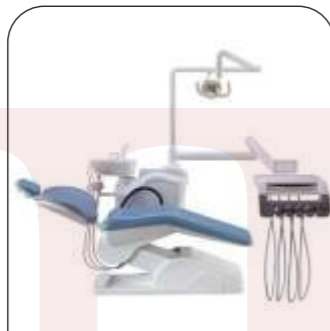

Model : MSLDU15

Single handle



Model : MSLDU16

popular dental chair



Model : MSLDU17

Top mounted dental chair



Model : MSLDU22-4

Folding Chair



Model : MSLDU25

Portable Dental Turbine



Model : MSLDU23

Portable Dental Turbine



Model : MSLDU24

Portable Dental Turbine



Model : MSLDU18

Best dental unit



Model : MSLDU29

Colorful dental unit



Model : MSLDU30A

LED dental unit



Model : MSLDU30B

LED dental unit



Model : MSLDU28

Portable Dental Turbine



Model : MSLDA05

dental compressor 1 for 1



Model : MSLDA06

dental compressor 1 for 2



Model : MSLDA07

dental compressor 1 for 3



Model : MSLDU33

Dental chair for clinic



Model : MSLDU34

Dental chair for massage



Model : MSLDU35

Dental chair for clinic



Model : MSLDU37

Children's dental chair



Model : MSLDA08

dental compressor 1 for 4



Model : MSLDX02

Film Viewer



Model : MSLBL06

Brushless Micromotor Polisher



Model : MSLBL02

Polisher



Model : MSLK02
Portable X-ray



Model : MSLK03
Portable X-ray



Model : MSLK04
Portable X-ray



Model : MSLK01
Portable X-ray



Model : MSL06C
dental microscope



Model : MSL06A
dental microscope



Model : MSLSS06
Built in scaler



Model : MSLSS11
Ultrasonic scaler



Model : MSLBL13
Brushless Micromotor Polisher



Model : MSLPSH03
18L Dental Autoclave



Model : MSLML68
Sterilizer



Model : MSLML75
23L Autoclave



Model : MSLSS08
Ultrasonic scaler



Model : MSLSS09
Ultrasonic scaler

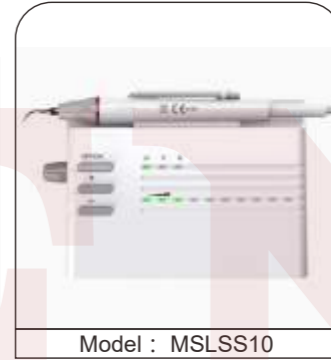

Model : MSLSS10
Ultrasonic scaler



Model : MSLCC01
Curing light



Model : MSLML70
class B Autoclave



Model : MSLML72
Intelligent Sterilizer



Model : MSLML77
18L Autoclave



Model : MSL3D01
High Precision DLP 3D printer



Model : MSLCC02
Curing light



Model : MSLCC07
Curing light



Model : MSLSS12
Ultrasonic scaler



Model : MSLCC05
Curing light



Model : MSLML82
handpiece refuel machine



Model : MSLSS01
Periodontal Treatment Device



Model : MSLSS02
Periodontal Treatment Device



Model : MSLSS03
Ultrasonic scaler

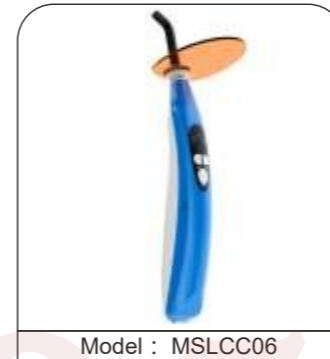

Model : MSLCC06
Curing light



Model : MSLCC09
Curing light



Model : MSLCC10
Curing light



Model : MSLCC12
Curing light



Model : MSLCC13
Curing light



Model : MSLAL01
Apex locator



Model : MSLAL02
Apex locator



Model : MSLAL04
Apex locator



Model : MSLDLS01
Medical Diode Laser System



Model : MSLDLS02
Medical Diode Laser System



Model : MSLDLS03
Medical Diode Laser System



Model : MSLIS02
Intraoral Sensor



Model : MSLAL05
Apex locator



Model : MSLTH01
Dental turbine handpiece



Model : MSLTH04
Dental turbine handpiece



Model : MSLTH02
Dental turbine handpiece



Model : MSLTH03
Dental turbine handpiece



Model : MSLIS03
Intraoral Sensor



Model : MSLDX03
Digital Panoramic Dental X-ray machine



Model : MSLDX04
Digital Panoramic Dental X-ray machine



Model : MSLDX05
Digital Panoramic Dental X-ray machine



Model : MSLDX01
Mobile X-ray



Model : MSLDX02
Mounted X-ray



Model : MSLDX06
Mobile Dental X-ray



Model : MSLDX08
Mobile X-ray



Model : MSLTH05
Dental turbine handpiece



Model : MSLTH06
Dental turbine handpiece



Model : MSLTH07
Complete set handpiece



Model : MSLTH08
Complete set handpiece



Model : MSLDX09
Dental X-Ray Film Processor



Model : MSLLA05
lead apron



Model : MSLLA06
lead apron



Model : MSLLA07
High collar apron



Model : MSLLA08
Protective collar



Model : MSLRP01
X-Ray Positioner



Model : MSLSP01
Sensor Positioner



Model : MSLSP02
Film Viewer

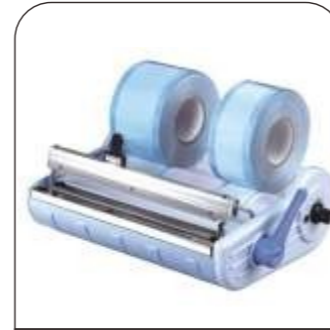

Model : MSLD22
Sealing Machine



Model : MSLD11
Distilled water machine



Model : MSLOM01
Oiling machine



Model : MSLSB01
Sealed bag



Model : MSLSP03
Film Viewer



Model : MSLDF01
Dental X-Ray Film



Model : MSLDF02
Dental X-Ray Film



Model : MSLDF04
Carestream Film



Model : MSLMB01
Teeth whitening instrument



Model : MSLMB02
Cold Light Teeth whitening instrument



Model : MSLMB03
Teeth whitening instrument



Model : MSLMB04
whitening gel



Model : MSLDF05
D-Speed



Model : MSLDF06
Kodak Film



Model : MSLSP03
Air Scale



Model : MSLRM01
Dental Root measure



Model : MSLMB07
Teeth whitening instrument



Model : MSLMB05
whitening gel



Model : MSLMB06
Cold Light Teeth whitening instrument



Model : MSLBS02
Dental color plate



Model : MSLRM03
Root measure



Model : MSLUC01
Ultrasonic Cleaner



Model : MSLUC02
Ultrasonic Cleaner



Model : MSLD33
Sealing Machine



Model : MSLBS03
Dental color plate



Model : MSLHM01
Dental goggle



Model : MSLHM02
Dental goggle



Model : MSLMG01
Mouth gag



Model : MSLFS01
Face mask



Model : MSLTT01
Teeth tray



Model : MSLTT02
Teeth tray



Model : MSLML01
Mouth lens



Model : MSLB01
Metal Bracket



Model : MSLD01
Dental Spreader



Model : MSLD02
Burnishing Stick



Model : MSLD03
Rubber Ring

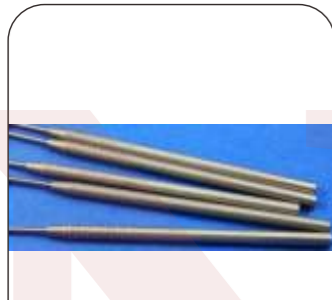

Model : MSLML02
Mouth lens handle



Model : MSLCB01
Coated Brush



Model : MSLYG02
Amalgam machine



Model : MSLS01
Sandblasting Scaler



Model : MSLD04
Barbed Broach

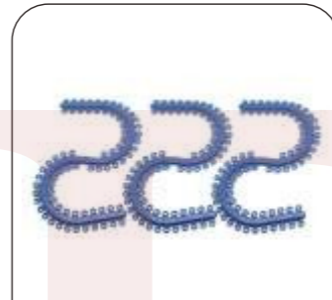

Model : MSLD05
Separator



Model : MSLD06
Grinding Head



Model : MSLD07
Gutta Perches



Model : MSLSP01
Scaling Powder



Model : MSLCR02
Dental Composite Resin



Model : MSLS03
Sandblasting Scaler



Model : MSLM01
Micro Printer



Model : MSLD08
Root Canal File



Model : MSLD09
Carving Set



Model : MSLD10
Dental Spreader



Model : MSLD11
Dental Probe



Model : MSLPM02
Micro Polishing machine



Model : MSLPM07
Micromotor Polisher



Model : MSLPM04
Brushless Micromotor Polisher



Model : MSLT02
Cutter machine



Model : MSLD12
Dental Cot



Model : MSLD13
Scaler Needle



Model : MSLD14
Buccal Tube



Model : MSLD15
Brace Arch Wire



Model : MSLGA01
TFT Anesthesia Machine



Model : MSLGA02
LCD Anesthesia Machine



Model : MSLGA04
LCD Anesthesia Machine



Model : MSLGA05
TFT Anesthesia Machine with 2 vaporizer



Model : MSLGA23
12.1"LCD Anesthesia Machine



Model : MSLGA25
10.2"LCD Anesthesia Machine



Model : MSLGA27
15"LCD Anesthesia Machine



Model : MSLGB01
1.7" TFT Anesthesia Machine



Model : MSLGA06
LCD Anesthesia Machine with 2 vaporizer



Model : MSLGA07
Portable Anesthesia Machine



Model : MSLGA07Plus
Portable Anesthesia Machine



Model : MSLGA11
5.4"LCD Display Anesthesia Machine



Model : MSLGB04
Anesthesia Machine



Model : MSLVM01
Ventilator with air compressor



Model : MSLVM03
Ventilator



Model : MSLPA01
Portable Ventilator



Model : MSLGA08
Anesthesia Machine



Model : MSLGA14
High End Anesthesia Machine



Model : MSLGA15
High End 10.4"LCD Anesthesia Machine



Model : MSLGA17
Trolley Anesthesia Machine



Model : MSLVM04
Portable Emergency Ventilator



Model : MSLVM05
Ventilator



Model : MSLVM06
Portable Ventilator



Model : MSLVM07
Ventilator



Model : MSLGA19
Anesthesia Machine



Model : MSLGA20
Portable Anesthesia Machine



Model : MSLGA21
7"LCD Anesthesia Machine



Model : MSLGA22
8"LCD Anesthesia Machine



Model : MSLVM08
Ventilator with built-in battery



Model : MSLVM09
Ventilator



Model : MSLVM10
Ventilator without air compressor



Model : MSLVM11
Ventilator with air compressor



Model : MSLVM15
Ventilator with 15" Removable touch screen



Model : MSLVM17
Portable Ventilator with built-in battery



Model : MSLVM18
Portable Ventilator with built-in battery



Model : MSLVM20
Ventilator with built-in battery



Model : MSLEC07
Twelve channels ECG



Model : MSLEC14
Single channel ECG



Model : MSLEC15
Single channel ECG



Model : MSLEC21
Twelve channels ECG



Model : MSLVM22
home care Ventilator



Model : MSLVM23
Emergency Ventilator



Model : MSLVM25
Ventilator for infant



Model : MSLVM26
Ventilator for infant



Model : MSLEC18
Three channels ECG



Model : MSLEC28
Six channels ECG



Model : MSLEC29
Twelve channels ECG



Model : MSLEC30
Single channel ECG



Model : MSLC01
non-invasive ventilator



Model : MSLC05
Sleep Ventilator



Model : MSLC07
Sleep Ventilator for children



Model : MSLC08
Sleep Ventilator for children



Model : MSLEC32
Six channels ECG



Model : MSLEC33
Twelve channels ECG machine



Model : MSLEC08
ECG machine



Model : MSLPM50
Ambulatory Blood Pressure Monitor



Model : MSLC09
CPAP non-invasive ventilator



Model : MSLC13
CPAP non-invasive ventilator



Model : MSLC11
CPAP non-invasive ventilator



Model : MSLC12
CPAP non-invasive ventilator



Model : MSLHT01
Holter ECG Twelve channels



Model : MSLHT02
Holter ECG Twelve channels



Model : MSLHT03
Holter ECG Three channels



Model : MSLDM02
Fetal monitor

Surgical Room

Surgical Room



Model : MSLMP07
Patient Monitor



Model : MSLMP08
Patient Monitor

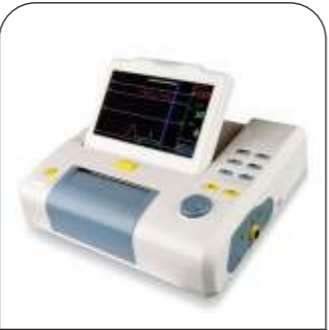

Model : MSLMP11
Patient Monitor



Model : MSLDM01
Patient Monitor



Model : MSLMP06
Patient Monitor 6 Parameters



Model : MSLMP09
Patient Monitor



Model : MSLMP10
Patient Monitor



Model : MSLIS10
Mini Syringe pump



Model : MSLMP12
12.1 inch Patient Monitor



Model : MSLMP13
15 inch Patient Monitor



Model : MSLMP14
Patient Monitor



Model : MSLMP16
10.4 inch Patient Monitor



Model : MSLIS14
Syringe pump

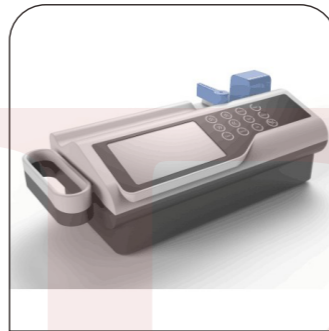

Model : MSLIS11
Handheld Syringe Pump



Model : MSLIS12
Single channel Syringe pump



Model : MSLIS13
Infusion pump



Model : MSLMP17
Patient Monitor



Model : MSLMP18
15 inch Patient Monitor



Model : MSLMP19
12 inch Patient Monitor



Model : MSLMP20
Patient Monitor



Model : MSLIS18
6 Channels Syringe pump



Model : MSLIS15
Syringe pump



Model : MSLIS16
Dual Channels Syringe pump



Model : MSLIS17
4 Channels Syringe pump



Model : MSLMP21B
Veterinary Patient Monitor



Model : MSLMP24
Patient Monitor
Veterinary and human use



Model : MSLMP25
Patient Monitor
Veterinary and human use



Model : MSLMP05
Patient Monitor
Veterinary and human use



Model : MSLIS19
8 Channels Syringe pump



Model : MSLIS07
Infusion Pump



Model : MSLIS21
Infusion Pump



Model : MSLIS22
Infusion Pump

Surgical Room

Surgical Room



Model : MSLIS26
Infusion Pump



Model : MSLIS27
Infusion Pump



Model : MSLIS28
Infusion Pump



Model : MSLIS29
Feeding Pump



Model : MSLET07
Operating table (head controlled)



Model : MSLET08
Operating table (side controlled)



Model : MSLET09
Operating table (side controlled)



Model : MSLET10
Operating Table



Model : MSL8000C
Defibrillator(Biphasic)



Model : MSL9000C
Defibrillator(Monophasic)



Model : MSL8000A
Defibrillator(Biphasic)



Model : MSL9000A
Defibrillator(Monophasic)



Model : MSLET11
Electric obstetrics hospital bed



Model : MSLET12
Obstetric Table



Model : MSLET13
Multi purpose delivery bed



Model : MSLET14
Manual delivery bed



Model : MSL8000D
Defibrillator(Biphasic)



Model : MSL9000D
Defibrillator(Monophasic)



Model : MSLAE06
AED



Model : MSLAE07
AED



Model : MSLET15
Gynecological examination bed



Model : MSL1A
Electrical operation bed



Model : MSL2A
operation bed



Model : MSL3A
Orthopedics operation bed



Model : DM7000
Defibrillator



Model : AED7000
AED



Model : MSLET05
Electric hydraulic table



Model : MSLET06
Electric operating table



Model : MSL4A
Integrated operation bed



Model : MSL5A
Integrated operation bed



Model : MSL6A
Integrated operation bed



Model : MSL7A
Integrated operation bed



Model : MSL8A
Electric operating table



Model : MSL9A
Electric operating table



Model : MSL10A
Electric operating table



Model : MSLDT01
ICU Suspension bridge



Model : MSL082
Single head Operating Lamp



Model : MSL097
Examination light



Model : MSL116
Operating Lamp



Model : MSL105
Wall mounted examination light



Model : MSLDT02
ICU Suspension bridge



Model : MSLDT03
ICU Suspension bridge



Model : MSLDT04
ICU Suspension bridge



Model : MSL006
Mobile operation light



Model : MSL106
Mobile light



Model : MSL109
Operating Lamp



Model : MSL110
Operating Lamp



Model : MSL113
Mobile Operating Lamp



Model : MSL010
Operating Lamp



Model : MSL027
LED oOperating Lamp



Model : MSL042
Mounted LED Operating Lamp



Model : MSL046
Dual head Operating Lamp



Model : MSL117
Ceiling Operating Lamp



Model : MSL-260
Vein finder



Model : MSL-261
Vein finder



Model : MSL-262
Vein finder



Model : MSL060
Mobile Operating Lamp



Model : MSL068
Halogen Operating Lamp



Model : MSL074
Mobile Operating Lamp



Model : MSL081
Mounted Operating Lamp



Model : MSL-263
Vein finder



Model : MSL-266
Vein finder



Model : MSL-265
Vein finder



Model : MSLDB01
Baby Scale

Surgical Room

Surgical Room



Model : MSLDB02
Infant Digital Scale



Model : MSLDB04
Infant Digital Scale



Model : MSLAS06
Animal Scale



Model : MSLPO-A
Handheld Oximeter



Model : MSLXV02
Vet Pulse Oximeter



Model : MSLXY05
Pulse Oximeter



Model : MSLXY06
Pulse Oximeter



Model : MSLXY07
Pulse Oximeter

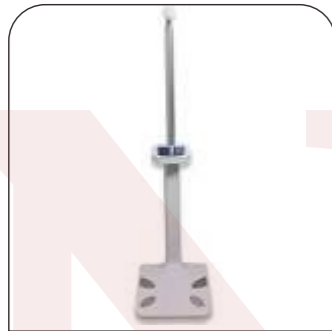

Model : MSLMH02
Scale With Height Measurement

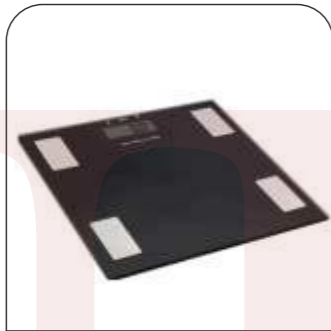

Model : MSLFS02
Bluetooth Baby Fat Scale



Model : MSLDW03
Pet Incubator



Model : MSLPO-E
Pulse Oximeter



Model : MSLXY08
Pulse Oximeter



Model : MSLXY09
Pulse Oximeter



Model : MSLXY10
Pulse Oximeter



Model : MSLCN22
Nebulizer with compressor



Model : MSLPO-B
Handheld Oximeter



Model : MSLPO-C
Pulse Oximeter



Model : MSLV91
Vital Signs Monitor



Model : MSLV92
Vital Signs Monitor



Model : MSLCN23
Nebulizer with compressor



Model : MSLMN31
Mesh Nebulizer



Model : MSLMN32
Mesh Nebulizer



Model : MSLDM-YWH01
Portable Nebulizer



Model : MSLV90A
Vital Signs Monitor



Model : MSLV94
Vital Signs Monitor



Model : MSLXY02
Pulse Oximeter



Model : MSLXV01
Vet Pulse Oximeter



Model : MSLCN26
Small Nebulizer



Model : MSLCN27
Portable Nebulizer



Model : MSLCN28
Portable Nebulizer



Model : MSLDM-YWH05
Nebulizer with screen



Model : MSL3N
oxygen concentrator



Model : MSLJY01
Home use Oxygen Concentrator



Model : MSLJY5B
5L medical Oxygen Concentrator



Model : MSLOCA1
5L Oxygen Concentrator



Model : MSL-23C-I



Model : MSL-23C-III
Mobile Electric Suction Unit



Model : MSL-23D-I
Mobile Electric Suction Unit



Model : MSLMVA1
MUA kits



Model : MSLOCA5
15L Oxygen Concentrator



Model : MSLOCA6
20L Oxygen Concentrator



Model : MSLZY02
8L medical Oxygen Concentrator



Model : MSLZJ05
5L Portable Oxygen Concentrator



Model : MSLSJ01
Infusion Warmer



Model : MSLSJ01Plus
Infusion Warmer



Model : MSLSJ02
Fluid/Blood Infusion Warmer



Model : MSLCL01
cold light source



Model : MSLZY07
5L Medical Oxygen Concentrator



Model : MSLZY11
5L Portable Oxygen Concentrator



Model : MSLZY09
5L Medical Oxygen Concentrator



Model : MSL9E-D
Electric Suction Unit



Model : MSLCL04
cold light source



Model : MSLCL05
cold light source



Model : MSLCL02
cold light source



Model : MSLCL03
cold light source



Model : MSL-23A-I
Electric Suction Unit



Model : MSL-23A-II
Electric Suction Unit



Model : MSL-23B-II
Emergency Portable Suction Unit



Model : MSL9E-A
Portable Phlegm Suction Unit



Model : MSLCL06
cold light source



Model : MSLEEG-C
EEG Machine



Model : MSLEEG-D
EEG Machine



Model : MSLEMG-P
EEG Machine



Model : MSLEL01
Extracorporeal Shock Wave Lithotripter



Model : MSLEL02
Extracorporeal Shock Wave Lithotripter



Model : MSLYM08
Paunch Flusher



Model : MSLYM18
Paunch Flusher



Model : MSLTD03
3W LED Medical head light



Model : MSLTD04
5W LED Medical head light



Model : MSLFDJ1
Medical Magnifier



Model : MSLAP02
Air Purifying Screen



Model : MSLYM19
Paunch Flusher



Model : MSLEK05
300W Electrosurgical Generator



Model : MSLEK08
400W Electrosurgical Generator



Model : MSLEK09
400W Electrosurgical Generator



Model : MSLSC01
Medical Lamp



Model : MSLSC01J
Medical Examination Lamp



Model : MSLSC01G
Medical Examination Lamp



Model : MSLSC02
Medical Examination Lamp



Model : MSLEK11
300W Electrosurgical Generator



Model : MSLEK12
250W Electrosurgical Generator



Model : MSLEK13
200W Electrosurgical Generator



Model : MSLEK14
200W Electrosurgical Generator



Model : MSLAP03
Ozone Disinfection Machine



Model : MSLAP04
Air cleaner



Model : MSLAP05
Air cleaner

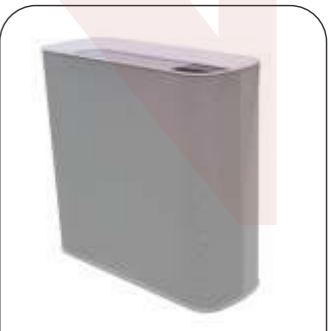

Model : MSLAP06
Air cleaner



Model : MSLCI01
Co₂ Insufflator



Model : MSLCI02
2-40L/min LCD CO₂ in suffator



Model : MSLCI03
10-30L/min LCD CO₂ in suffator



Model : MSLTD01
3W LED head light



Model : MSLAP07
Plasma Air Purifying Machine



Model : MSLAP08
Plasma Air Purifying Machine



Model : MSLZX01
Single Tunnel Automatic Tourniquet System



Model : MSLZX02
Single Tunnel Automatic Tourniquet System



Model : MSLZX04
Hand pump
Automatic Tourniquet System



Model : MSLGY01
Irrigation pump



Model : MSLGY02
Irrigation pump



Model : MSL-JZK003
Electronic blood pressure monitor



Model : MSL-U106
Infrared thermometer



Model : MSL-121
Infrared thermometer



Model : MSL-Z8806
Infrared thermometer



Model : MSL-125
Infrared thermometer



Model : MSL-JZK001
Digital blood pressure monitor



Model : MSL-JZK002
Digital blood pressure monitor



Model : MSL-JZKB02
Digital blood pressure monitor



Model : MSL-JZKB01
Digital blood pressure monitor



Model : MSLW8B
Blood pressure monitor



Model : MSLSP02
Sphygmomanometer



Model : MSLST03
Single head stethoscope



Model : MSLST04
Sprague thermometer



Model : MSLST05
Dual head stethoscope



Model : MSLSP01
Sphygmomanometer



Model : MSL-202B
Digital thermometer

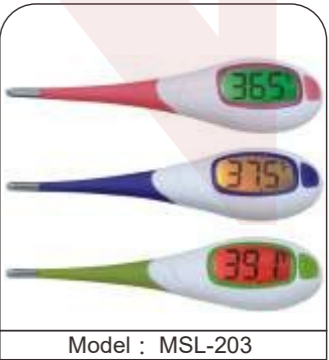

Model : MSL-203
Digital thermometer



Model : MSLB6A
Blood pressure monitor



Model : MSLB6B
Blood pressure monitor



Model : MSLW8A
Blood pressure monitor



Model : MSL-200
Infrared thermometer



Model : MSL-Z200
Digital thermometer



Model : MSL-B123
Digital thermometer



Model : MSL-S4320
Digital thermometer



Model : MSL-B903
Digital thermometer

Surgical Room

Surgical Room



Model : MSLHM01
Hemodialysis Machine



Model : MSLHM02
Hemodialysis Machine



Model : MSLHM03
Hemodialysis Machine



Model : MSLHM04
Hemodialysis Machine



Model : MSLHM05
Hemodialysis Machine



Model : MSLHM06
Hemodialysis Machine



Model : MSLHM07
Hemodialysis Machine



Model : MSLHM08
Hemodialysis Machine



Model : MSLRO01
RO water system



Model : MSLHP01
Hemoperfusion Machine



Model : MSLHP02
Hemoperfusion Machine



Model : MSLCH01
Hemodialysis Chair



Model : MSLCH02
Hemodialysis Chair



Model : MSLCH03
Hemodialysis Chair



Model : MSLK221
Rotary Microtome



Model : MSLK222
Rotary Microtome



Model : MSLK223
Semi-automatic Microtome



Model : MSLK224
Fully Automated Microtome



Model : MSLK225
Fully Automated Microtome



Model : MSLK226
Microtome



Model : MSLK227
Microtome



Model : MSLK228
Cryostat Microtome



Model : MSLK229
Cryostat Microtome



Model : MSLK230
Rotary Microtome



Model : MSLTF01
Inkjet Printer



Model : MSLK231
Rotary Microtome



Model : MSLTB01
Tissue Water Bath



Model : MSLTE01
Tissue Embedding



Model : MSLTE03
Tissue embedding



Model : MSLTE02
Tissue Embedding



Model : MSLTS03
Tissue Processor



Model : MSLTR01
Automatic Tissue Stainer



Model : MSLTS01
Tissue processor



Model : MSLTS02
Tissue Embedding



Model : MSLTS04
Tissue Processor



Model : MSLSDT01
Glass Microscope Slide Staining Dish Tray



Model : MSLSDT02
Stainless Steel Rack



Model : MSL-6M
Slit lamp



Model : MSL-6H
Slit lamp



Model : S150
Portable Slit lamp



Model : MSL-JER
Slit Lamp



Model : MSL6CR02
Integrated type Automatic Perimeter
(touch screen)



Model : MSLT90
Split type Perimeter



Model : MSLRM01
Auto Refractometer



Model : MSLKM01
Auto Refractometer



Model : MSL-1ER
Slit Lamp (Magnification
change way: Deflector Rod)



Model : MSL-2ER-L
Slit Lamp (Magnification
change way: Drum Three Magnifications)



Model : MSL-6L
Slit lamp



Model : MSL-4ER
Digital Slit Lamp
(10 Mega Pixels Resolution)



Model : MSLFA65
Auto Refractometer



Model : MSLFA61
Auto Refractometer



Model : MSLFA61A
Auto Refractometer



Model : MSLFA60A
Auto Refractometer



Model : MSL-3ER
Digital Slit Lamp
(24.1 Mega Pixels Resolution)



Model : MSL-3ER-E
Digital Slit Lamp



Model : S390H
Slit Lamp with halogen
lamp light source



Model : S390L
Slit Lamp



Model : MSLHA01
Handheld vision screener



Model : MSL20P
Operation microscope



Model : MSL20P5
Operation microscope



Model : MSL20T4
Operation microscope



Model : MSL-DER
Fundus camera &
Fluorescein angiography system



Model : MSL-2000BER
Ophthalmology ultrasound A/B Scan



Model : MSL6BR
Split type Automatic Perimeter



Model : MSL6CR01
Integrated type
Automatic Perimeter



Model : MSL6F
Direct ophthalmoscope

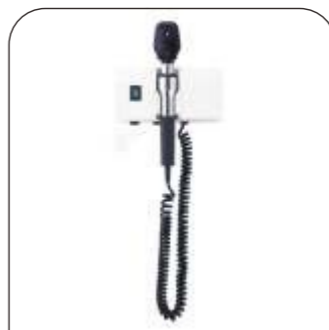

Model : MSL6G
Direct ophthalmoscope



Model : MSL11
Direct ophthalmoscope



Model : MSL11D
Chargeable Direct ophthalmoscope



Model : MSL24B
Streak Retinoscope



Model : MSL25C
Head light



Model : MSL30
Tonometer



Model : MSLYZ06
Rebound Tonometer



Model : TR-510A
Ophthalmic unit



Model : TR-510B
Ophthalmic unit



Model : TR-102A
Ophthalmic unit



Model : TR-510C
Ophthalmic unit

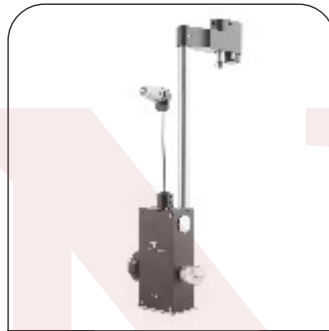

Model : T170(R)
Tonometer

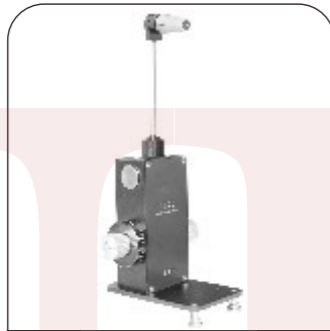

Model : T170(T)
Tonometer



Model : MSL24
Streak Retinoscope



Model : DCP-200
LCD Chart Projector



Model : MSL1000A
Ultrasonic A-Biometer



Model : MSL1000P
Ultrasonic P-Biometer



Model : MSLOD21S
Ultrasonic A/B Scanner



Model : MSLMD23S
Ultrasonic A/B Scanner



Model : MSLJD26A
7" Auto Lensmeter



Model : MSLJD26B
5.6" Auto Lensmeter



Model : MSLJD20
Auto Lensmeter



Model : MSLJD26
Auto Lensmeter



Model : MSLYZ08A
A Scan(Biometer)



Model : MSLYZ08P
Pachymeter



Model : MSLYZ09
A/B Scanner



Model : MSLYZ07
Vision Screener



Model : MSLYG100
Phoropter



Model : MSLVT5A
Phoropter



Model : MSLCP60
Chart Projector



Model : CP-400
Chart Projector



Model : MSLYZ05
Handheld corneal curvature meter



Model : 20D
Eyepiece mirror



Model : 78D
Eyepiece mirror



Model : 90D
Eyepiece mirror

Ophthalmology Room

Ophthalmology Room



Model : MSLOO2
Integrated Wall System



Model : MSLOO3
Integrated Wall System



Model : MSLOO1
Integrated Wall System



Model : MSLVL3R
Visual inspection otoscope



Model : MSLEJ03
Direct Otoscope



Model : MSLEJ04
Direct Otoscope



Model : MSLEJ05
Direct Otoscope



Model : MSLEJ06
Direct Otoscope



Model : MSLEJ07
Direct Otoscope



Model : MSLOO4
Integrated Wall System

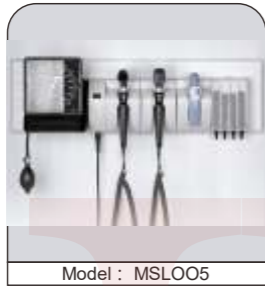

Model : MSLOO5
Integrated Wall System



Model : MSLVL4R
Visual inspection otoscope



Model : MSLEJ08
Direct Otoscope



Model : MSLEJ09
Direct Otoscope



Model : MSLEY01
Ear eye checker



Model : MSLEY02
Otoscope Ophthalmoscope



Model : MSLEY03
Otoscope Ophthalmoscope



Model : MSLVL2D
Video Laryngoscope



Model : MSLVL2R
Video Laryngoscope

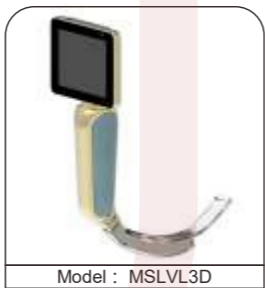

Model : MSLVL3D
Anesthesia video laryngoscope



Model : MSLVL1R
Airway Mobile Endoscope



Model : MSLEY04
Otoscope Ophthalmoscope



Model : MSLJY02
Otoscope Ophthalmoscope



Model : MSLJY03
Otoscope Ophthalmoscope



Model : MSLJY04
Otoscope Ophthalmoscope



Model : MSLJY05
Otoscope Ophthalmoscope



Model : MSLVL4D
Anesthesia video laryngoscope



Model : MSLVL5D
Anesthesia video laryngoscope



Model : MSLVL5R
Airway Mobile Endoscope



Model : MSLJY06
Otoscope Ophthalmoscope



Model : MSLJY08
Otoscope Ophthalmoscope



Model : MSLMHJ09
Laryngoscope



Model : MSLMHJ01
Laryngoscope



Model : MSLYM15
Audiometer



Model : MSLYM16
Audiometer



Model : MSLYM17
Audiometer



Model : MSLEJ01
Direct Otoscope



Model : MSLEJ02
Direct Otoscope



Model : MSLJY07
Otoscope Ophthalmoscope



Model : MSLMHJ02
Laryngoscope



Model : MSLMHJ03
Laryngoscope

ENT Room

ENT Room

ENT Room

ENT Room



Model : MSLWG01 ENT Diagnostic Set
 Model : MSLWG02 ENT Diagnostic Set
 Model : MSLWG03 ENT Diagnostic Set
 Model : MSLWG04 ENT Diagnostic Set
 Model : MSLWG05 ENT Diagnostic Set



Model : MSLWG06 ENT Diagnostic Set
 Model : MSLWG07 ENT Diagnostic Set
 Model : MSLWG08 ENT Diagnostic Set
 Model : MSLZY01 Wall mount type general diagnosis system
 Model : MSLA-60 Rechargeable Hearing aid



Model : MSLA-80 Rechargeable Hearing aid



Model : MSLA-155 Bluetooth Pocket Hearing aid
 Model : MSLC-108 Rechargeable Hearing aid
 Model : MSLF-28 Telephone pocket hearing aid



Model : MSLF-138 BTE Hearing aid
 Model : MSLF-883 Mini ITE Hearing aid
 Model : MSLJZ-1088A BTE Hearing aid



Model : MSLK-80 Mini ITE Hearing aid
 Model : MSLK-86 Mini ITE Hearing aid
 Model : MSLK-88 Rechargeable ITE hearing aid
 Model : MSLV-183 Bluetooth type hearing aid
 Model : MSLENT01 ENT Treatment Unit



Model : MSLENT02 ENT Treatment Unit



Model : MSLENT03 ENT Treatment Unit



Model : MSLENT04 ENT Treatment Unit



Model : MSLENT05 ENT Treatment Unit



Model : MSLENT06 ENT Treatment Unit



Model : MSLENT07 ENT Treatment Unit



Model : MSLENT08 ENT Treatment Unit



Model : MSLENT09 ENT Treatment Unit



Model : MSLENT10 ENT Treatment Unit



Model : MSLENT11 ENT Treatment Unit



Model : MSLENT12 ENT Treatment Unit



Model : MSLENT13 ENT Treatment Unit



Model : MSLENT14 Electric Patient Chair



Model : MSLENT15 Electric Patient Chair



Model : MSLENT16 Electric Patient Chair



Model : MSLYM15 Diagnostic Audiometer



Model : MSLBG01 Diagnosis station



Model : MSLBG02 Diagnosis station

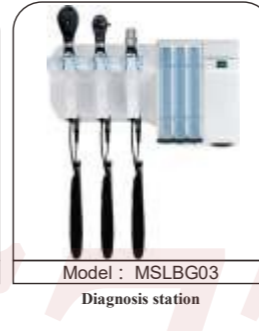

Model : MSLBG03 Diagnosis station



Model : MSLBG04 Diagnosis station

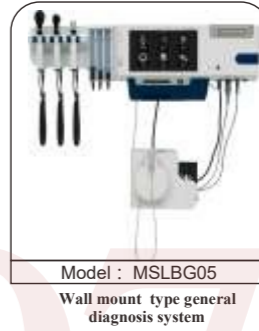

Model : MSLBG05 Wall mount type general diagnosis system



Model : MSLBG06 Wall mount type general diagnosis system



Model : MSLJM01

Percutaneous jaundice meter



Model : MSLHD01

Infant Jaundice Phototherapy Unit



Model : MSLHD02

Infant Jaundice Phototherapy Unit



Model : MSLHD09

Infant Jaundice Phototherapy Unit



Model : MSLBI23
Standard Infant Incubator



Model : MSLBI04
Standard Infant Incubator



Model : MSLBI24
Luxurious Infant Incubator



Model : MSLBI07
Standard Infant Incubator



Model : MSLBI04Plus

Top Grade Infant Incubator



Model : MSLBI08
Standard Infant Incubator



Model : MSLBI10
Standard Infant Radiant Warmer



Model : MSLHD03

Infant Jaundice Phototherapy Unit



Model : MSLHD04

Infant Jaundice Phototherapy Unit



Model : MSLHD05

Infant Jaundice Phototherapy Unit



Model : MSLHD06

Infant Jaundice Phototherapy Unit



Model : MSLHD08

Infant Jaundice Phototherapy Bed



Model : MSLBI10Plus
Top Grade Infant Radiant Warmer



Model : MSLBI11
Top Grade Infant Incubator



Model : MSLBI13
Infant Radiant Warmer



Model : MSLBI22
Infant Incubator



Model : MSLBI15
Infant Incubator



Model : MSLHD07

Infant Jaundice Phototherapy Blanket



Model : MSLHD10

Infant Jaundice Phototherapy Bed



Model : MSLHD11

Infant Jaundice Phototherapy Bed



Model : MSLHD12

Infant Jaundice Phototherapy Bed



Model : MSLBI16
Top Grade Infant Incubator



Model : MSLBI17
Top Grade Infant Incubator



Model : MSLBI25
Infant Radiant Warmer



Model : MSLBI19
Infant Radiant Warmer



Model : MSLBI20A
Top Grade Infant Radiant Warmer



Model : MSLHD13

Infant Jaundice Phototherapy Bed



Model : MSLHD14A

Infant Jaundice Phototherapy Unit



Model : MSLHD14B

Infant Jaundice Phototherapy Unit



Model : MSLHD14C

Infant Jaundice Phototherapy Unit



Model : MSLBI01

Standard Infant Incubator



Model : MSLBI12
Mobile Incubator



Model : BL-30 LED
Phototherapy unit



Model : BL-50 LED
Phototherapy unit



Model : BL-100 LED
Phototherapy unit



Model : Infant Resuscitator
Infant Resuscitator



Model : MSLMR01
1 Body Mortuary Freezer



Model : MSLMR02
2 Body Mortuary Freezer



Model : MSLMR03
3 Body Mortuary Freezer



Model : MSLMR04
4 Body Mortuary Freezer



Model : MSLMR06
6 Body Mortuary Freezer



Model : MSLMR09
9 Body Mortuary Freezer



Model : MSLMC01
Mortuary Trolley



Model : MSLMC02
Mortuary Trolley



Model : MSLMC03
Mortuary Trolley



Model : MSLMT01
Corpus Lift



Model : MSLMT02
Mortuary Freezer



Model : MSLCA01
Body Analyzer



Model : MSLCA02
Body Composition Analyzer



Model : MSLCA03
Body Composition Analyzer



Model : MSLCA04
Body Analyzer



Model : MSLCE01
Laptop Colposcope



Model : MSLCE02
Laptop Colposcope



Model : MSLCE03
Trolley Colposcope



Model : MSLCE04
Handheld Colposcope



Model : MSLCE05
Trolley Colposcope

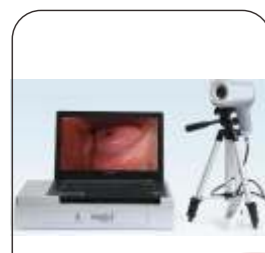

Model : MSL-9100A
High Resolution Colposcope



Model : MSL-9100C
Mobile Colposcope



Model : MSL-9200B
High Resolution Colposcope



Model : MSLCE06
Mobile Trolley Colposcope



Model : MSLCE07
Trolley Colposcope

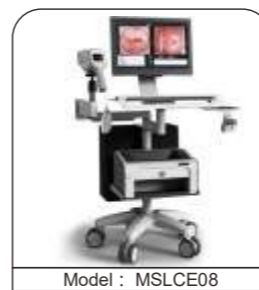

Model : MSLCE08
Colposcope



Model : MSLCE09
Colposcope Camera

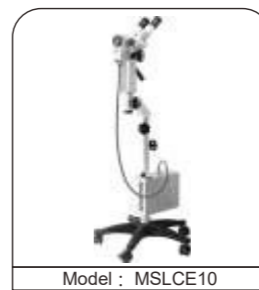

Model : MSLCE10
Colposcope Camera



Model : MSLPC02
Electric Plaster Saw

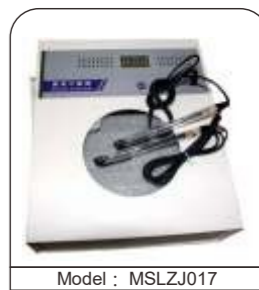

Model : MSLZJ017
Bacterial Colony Counter



Model : MSLZJ018
PH meter



Model : MSLZJ019
PH meter



Model : MSLZJ020
PH meter



Model : MSLZJ021
PH meter



Model : MSLTZ03
UV Disinfection Cabinet



Model : MSLTZ09
UV Disinfection Cabinet



Model : MSLNT01
EEG

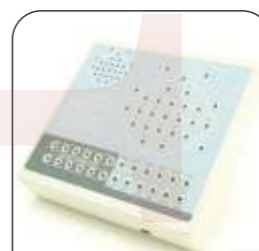

Model : MSLNT02
EEG



Model : MSLNT03
EEG



Model : MSLWI30B
30KG Incinerator



Model : MSLWI50B
50KG Incinerator



Model : MSLWI100B
100KG Incinerator



Model : MSLWI150
150KG Incinerator



Model : MSLWI300
300KG Incinerator



Model : MSLGS02
Gyeno Spoon



Model : MSLED01
3.5 inch HD Endoscope Camera

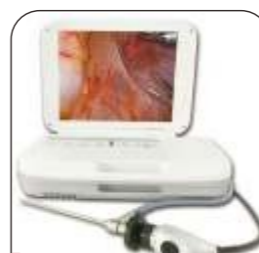

Model : MSLED02
15 inch Display Endoscope

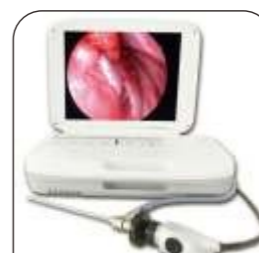

Model : MSLED03
15 inch Display Endoscope



Model : MSLED04
10 inch Display Endoscope



Model : MSLED05
3.5 inch Display Endoscope



Model : MSLDW01 Pet Incubator Model : MSLHG01 Pet dryer machine Model : MSLYZ03 Bed unit air disinfection machine Model : MSLYZ04 Bed unit air disinfection machine Model : MSLBU01 Bed unit air disinfection machine

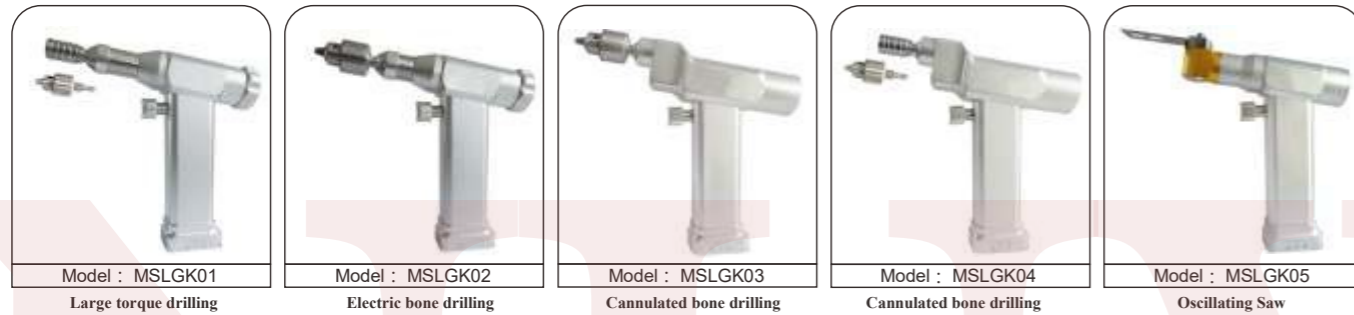

Model : MSLGK01 Large torque drilling Model : MSLGK02 Electric bone drilling Model : MSLGK03 Cannulated bone drilling Model : MSLGK04 Cannulated bone drilling Model : MSLGK05 Oscillating Saw

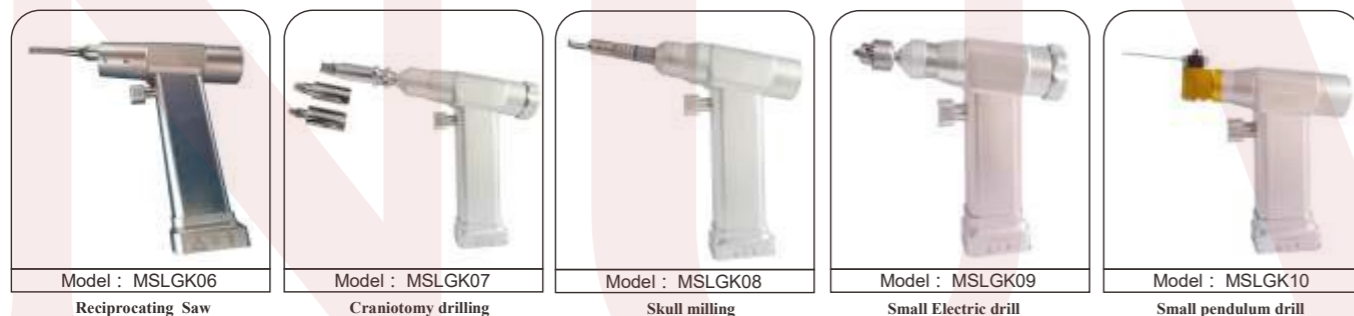

Model : MSLGK06 Reciprocating Saw Model : MSLGK07 Craniotomy drilling Model : MSLGK08 Skull milling Model : MSLGK09 Small Electric drill Model : MSLGK10 Small pendulum drill



Model : AQ-100 Endoscopy Solution Model : MSLVME23 Endoscopy System Model : MSLVME28 Full Endoscopy System Model : MSLXQ15 Washing Machine Model : MSLSD01 Vibration Sputum Discharge Machine



Model : MSLSD02 Vibration Sputum Discharge Machine Model : MSLSD04 Backpack Sputum Discharge Machine Model : MSL0T01 Medical Ozone Therapy unit Model : MSL0T02 Medical Ozone Therapy unit Model : MSL0T03 Medical Ozone Therapy unit



Model : MSLMD01 Medical Display Model : MSLMD02 Medical Display Model : MSLDS01 TV Model : MSLDS02 TV Model : MSLDS03 TV



Model : MSLBH01 Ambulance Model : MSLBZ24 Ambulance Model : MSLHC25 Ambulance Model : MSLJH51 Ambulance Model : MSLJH52 Ambulance



Model : MSLKT01
Central air conditioning



Model : MSLKT02
Vertical air conditioning



Model : MSLSX01
Camera



Model : MSLSX02
Camera



Model : MSLKT03
Wall mounted air conditioning



Model : MSLSX03
Camera



Model : MSLSX04
Camera



Model : MSLSX05
Camera



Model : MSLA01
Emergency Stretcher



Model : MSLHB04
Three crank manual hospital bed



Model : MSLHB06
Luxury Three Crank Hospital Bed



Model : MSLHB15
Three function Electric hospital bed



Model : MSLHB07
Five function electric bed



Model : MSLHB01
One crank manual hospital bed



Model : MSLHB08
Five function electric bed



Model : MSLHB10
Five function Electric hospital bed



Model : MSLHB02
Two crank manual hospital bed



Model : MSLHB09
Five function electric bed



Model : MSLHB11
Three function Electric hospital bed



Model : MSLHB03
Two crank manual hospital bed



Model : MSLHB16
Two function Electric hospital bed



Model : MSLHB12
Three function Electric hospital bed



Model : MSLHB13
Three function Electric hospital bed



Model : MSLHB14
Three function Electric hospital bed



Model : MSLHB23
Orthopaedic bed



Model : MSLHB22
Orthopaedic bed



Model : MSLHB19
Baby cabinet



Model : MSLHB20
Baby cabinet



Model : MSLHB21
Baby cabinet



Model : MSLHB17
Children's bed



Model : MSLHB18
Children's bed



Model : MSLTC01
Flat Hospital Bed



Model : MSLTC02
Two crank Hospital Bed



Model : MSLSS02
Two crank Hospital Bed



Model : MSLHC04
Two crank Hospital Bed



Model : MSLHC05
Multi-purpose Hospital Bed



Model : MSLHC02
Three Function Hospital Bed



Model : MSLHC03
Manual Hospital Bed



Model : MSLHC03
Multi-purpose Hospital Bed



Model : MSLHC06
Manual Hospital Bed



Model : MSLNC01
One crank Hospital Bed



Model : MSLNC02
Steel manual bed



Model : MSLTC01
Orthopaedic bed



Model : MSLTC02
Children's bed



Model : MSLSS02
Children's bed



Model : MSLSS02
Delivery Bed



Model : MSLBT01
Bedside Cabinet



Model : MSLBT02
Bedside Cabinet



Model : MSLBT03
Bedside Cabinet



Model : MSLBT04
Bedside Cabinet



Model : MSLCM01
Medical record trolley



Model : MSLCM02
Medical record trolley



Model : MSLBT05
Bedside Cabinet



Model : MSLBT06
Bedside Cabinet



Model : MSLMB02
Massage Chair



Model : MSLMB05
Patient Chair



Model : MSLBT07
Bedside Cabinet



Model : MSLMB03
Patient Chair



Model : MSLMB06
Mobile Treatment Chair



Model : MSLIC01
I.V Drip Chair



Model : MSLMB17
Beauty Bed



Model : MSLMB07
Examination Bed



Model : MSLMB08
Examination Bed



Model : MSLMB09
Electric Examination Bed



Model : MSLMB10
Mobile Examination Bed



Model : MSLMB11
Electric Examination Bed



Model : MSLMB17
Beauty Bed



Model : MSLMB12
Massage Bed



Model : MSLMB13
Electric Massage Bed



Model : MSLCS01
Treatment trolley



Model : MSLMB15
Beauty Bed



Model : MSLSSD01
Kick bucket



Model : MSLCS02
Stainless steel nursing trolley



Model : MSLWH05
commode wheelchair



Model : MSL-AT3
Over bed table



Model : MSL-AT4
Over bed table



Model : MSLCB01
Examination bed



Model : MSLLY01
Manual wheelchair



Model : MSLLY02
Manual wheelchair



Model : MSLWH01
steel manual wheelchair



Model : MSLLY06
Manual wheelchair



Model : MSLLY09
Manual wheelchair



Model : MSLLY04
Manual wheelchair



Model : MSLLY14
Manual wheelchair



Model : MSLLY11
Manual wheelchair

Medical Furniture

Medical Furniture



Model : MSLLY37
Electrical wheelchair



Model : MSLLY16
Manual wheelchair



Model : MSLLY19
Manual wheelchair



Model : MSLLY20
Manual wheelchair



Model : MSLLY21
Simple wheelchair



Model : MSLLY22
Simple wheelchair



Model : MSLLY30
Patient wheelchair



Model : MSLLY53
Medical trolley



Model : MSLLY50
Medical trolley



Model : MSLLY54
Medical trolley

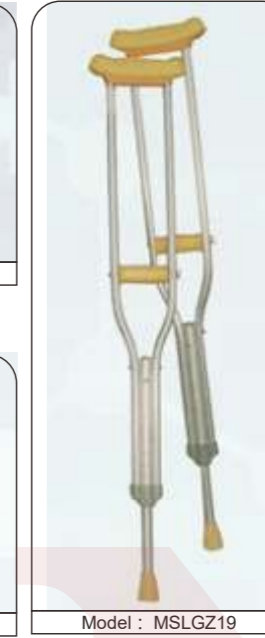

Model : MSLGZ19
Walking stick



Model : MSLGZ20
Walking stick



Model : MSLLY31
Electrical wheelchair



Model : MSLLY34
Manual wheelchair



Model : MSLLY36
Manual wheelchair



Model : MSLLY32
Disable chair



Model : MSLLY33
Disable chair

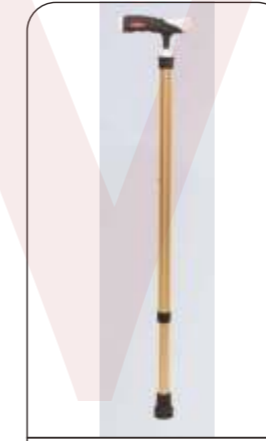

Model : MSLGZ06
Walking stick



Model : MSLGZ08
Walking stick

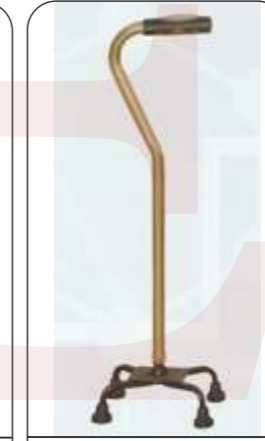

Model : MSLGZ23
Walking stick

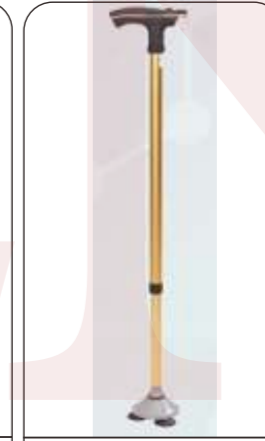

Model : MSLGZ09
Walking stick

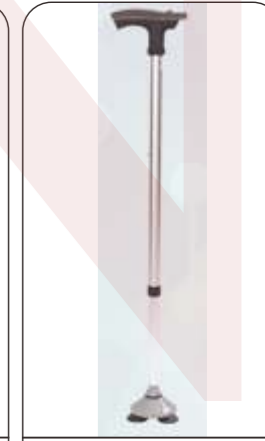

Model : MSLGZ10
Walking stick



Model : MSLLY48
Commode Wheelchair



Model : MSLLY49
Commode Wheelchair



Model : MSLLY45
Wheelchair



Model : MSLLY46
Wheelchair



Model : MSLLY47
Wheelchair



Model : MSLLY51
Medical trolley



Model : MSLLY52
Medical trolley



Model : MSLDZ01
Hospital chair



Model : MSLDZ02
Hospital chair



Model : MSLDZ03
Hospital chair



Model : MSLGZ11
Walking stick



Model : MSLGZ12
Walking stick



Model : MSLGZ13
Walking stick



Model : MSLGZ14
Walking stick



Model : MSLGZ15
Walking stick

Medical Furniture

Medical Furniture



Model : MSLGZ01 walking stick
 Model : MSLGZ02 walking stick
 Model : MSLGZ04 walking stick
 Model : MSLGZ05 walking stick
 Model : MSLGZ18 Walking stick

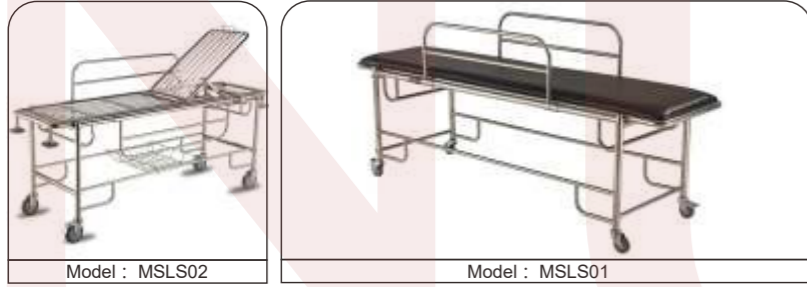

Model : MSLS02 Patient trolley with mattress
 Model : MSLS01 Stainless steel stretcher



Model : MSLDC05 Examination Bed



Model : MSLHC01 Waiting Chair
 Model : MSLHC07 Waiting Chair&Bed
 Model : MSLHC02 Waiting Bed



Model : MSLS02 Patient trolley with mattress
 Model : MSLHC05 Waiting Chair
 Model : MSLHC03 Waiting Chair
 Model : MSLHC04 Sofa
 Model : MSLHC08 Long Waiting Sofa



Model : MSLBB04 Children's bed
 Model : MSLBB05 Children's bed
 Model : MSLBB01 Children's bed
 Model : MSLSSD01 Kick bucket
 Model : MSLST001 operation cart



Model : MSLMS01 Four fold screen
 Model : MSLMS02 Three fold screen
 Model : MSLHC09 Wash Basin
 Model : MSLHC10 Wash Basin
 Model : MSLHC11 Desk for doctor

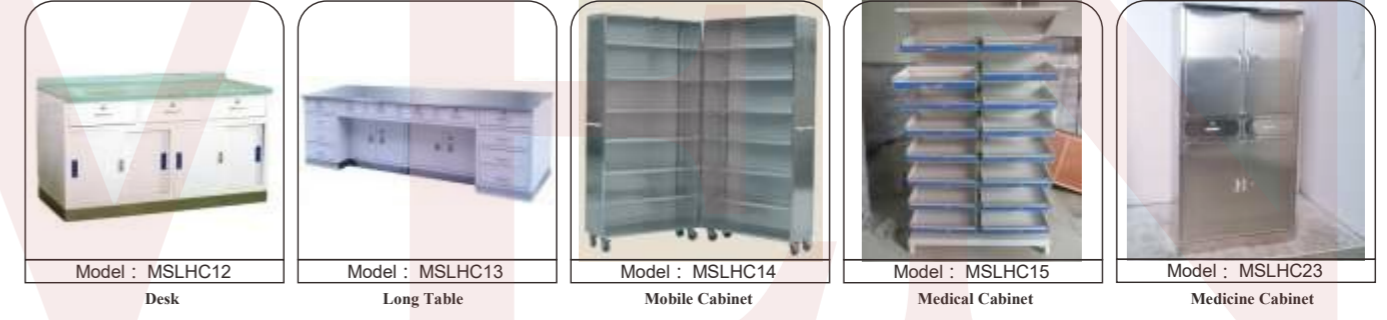

Model : MSLHC12 Desk
 Model : MSLHC13 Long Table
 Model : MSLHC14 Mobile Cabinet
 Model : MSLHC15 Medical Cabinet
 Model : MSLHC23 Medicine Cabinet



Model : MSLHC16 Medicine Cabinet
 Model : MSLHC17 Cabinet
 Model : MSLHC18 Cabinet



Model : MSLDC07 Medicine Cabinet



Model : MSLHC19 Document Cabinet
 Model : MSLHC20 Medical Record Cabinet
 Model : MSLHC21 Medical Document Cabinet



Model : MSLHC24
Four Door Cabinet



Model : MSLHC25
Six Door Cabinet



Model : MSLHC26
Changing Room Cabinet



Model : MSLHC22
Medical Cabinet



Model : MSLHC28
Medical Cabinet



Model : MSLHC45
Medical Clothes trolley



Model : MSLHC46
Treatment trolley



Model : MSLHC50
Treatment trolley



Model : MSLHC51
Medical record trolley



Model : MSLHC53
Infections goods trolley



Model : MSLHC27
Medical Cabinet

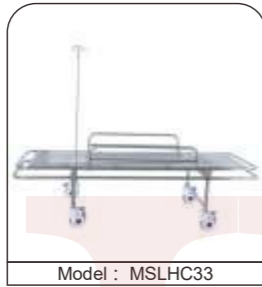

Model : MSLHC33
Steel Infusion Stretcher



Model : MSLHC31
Trolley Infusion Stretcher



Model : MSLHC34
Treatment trolley



Model : MSLHC55
Anesthesia trolley



Model : MSLHC54
Nursing trolley



Model : MSLHC58
Treatment trolley



Model : MSLHC75
Transfusion trolley



Model : MSLHC35
Patient trolley



Model : MSLHC36
Baby trolley



Model : MSLHC03
Children's bed



Model : MSLHC59
Nursing trolley



Model : MSLHC60
ABS Baby trolley



Model : MSLHC61
Transfusion trolley



Model : MSLHC37
Baby trolley



Model : MSLHC38
instrument trolley



Model : MSLHC03
Dressing trolley



Model : MSLHC40
Stainless steel trolley



Model : MSLHC41
instrument cart



Model : MSLHC62
ABS trolley for sending drug



Model : MSLHC63
Transfusion trolley



Model : MSLHC64
Transfusion trolley



Model : MSLHC65
Treatment trolley



Model : MSLHC66
Treatment trolley



Model : MSLHC42
Infusion Trolley



Model : MSLHC01
Mobile Trolley



Model : MSLHC43
Medicine Carrying Trolley



Model : MSLHC44
Infusion Trolley



Model : MSLHC48
Medicine Waste Trolley



Model : MSLHC67
Treatment trolley



Model : MSLHC68
Treatment trolley



Model : MSLHC69
Anesthesia trolley



Model : MSLHC70
ABS trolley for drug



Model : MSLHC71
ABS trolley for drug



Model : MSLHC13
Long Table



Model : MSLHC14
Mobile Cabinet



Model : MSLHC15
Medical Cabinet



Model : MSLDC07
Medicine Cabinet



Model : MSLHC16
Medicine Cabinet



Model : MSLHC17
Cabinet



Model : MSLHC18
Cabinet



Model : MSLHC19
Document Cabinet



Model : MSLHC20
Medical Record Cabinet



Model : MSLHC21
Medical Document Cabinet



Model : MSLHC22
Medical Cabinet



Model : MSLHC23
Medicine Cabinet



Model : MSLHC24
Four Door Cabinet



Model : MSLHC25
Six Door Cabinet



Model : MSLHC26
Changing Room Cabinet



Model : MSLHC27
Medical Cabinet



Model : MSLHC28
Medical Cabinet



Model : MSLHC29
Infusion Stretcher



Model : MSLHC30
Mobile Infusion Stretcher



Model : MSLHC31
Trolley Infusion Stretcher



Model : MSLHC32
Infusion Stretcher



Model : MSLHC33
Steel Infusion Stretcher



Model : MSLHC34
Treatment trolley



Model : MSLHC35
Patient trolley



Model : MSLHC36
Baby trolley



Model : MSLHC03
Children's bed



Model : MSLHC37
Baby trolley



Model : MSLHC38
instrument trolley



Model : MSLHC03
Dressing trolley



Model : MSLHC39
Dressing trolley



Model : MSLHC40
Stainless steel trolley



Model : MSLHC41
instrument cart



Model : MSLHC42
Infusion Trolley



Model : MSLHC01
Mobile Trolley



Model : MSLHC45
Medical Clothes trolley



Model : MSLHC43
Medicine Carrying Trolley



Model : MSLHC44
Infusion Trolley



Model : MSLHC48
Medicine Waste Trolley



Model : MSLHC46
Treatment trolley



Model : MSLHC47
Mobile Trolley



Model : MSLHC49
Gas Cylinder Trolley

Medical Furniture

Medical Furniture



Model : MSLHC72
Treatment trolley



Model : MSLHC73
Emergency trolley



Model : MSLHC74
Treatment trolley



Model : MSLHC78
Emergency trolley



Model : MSLHC79
Anesthesia trolley



Model : MSLHC76
Transfusion trolley



Model : MSLHC77
Emergency trolley



Model : MSLHC80
Emergency trolley



Model : MSLHC82
Emergency trolley



Model : MSLHC83
Yellow Emergency trolley



Model : MSLHC84
Emergency Cart



Model : MSLHC85
ABS Emergency trolley



Model : MSLHC86
Emergency Nursing Trolley



Model : MSLHC87
Mobile Cart



Model : MSLHC88
Treatment trolley



Model : MSLAM01
Air Mattress



Model : MSLAM02
Air Mattress



Model : MSLAM03
Air Mattress



Model : MSLAM04
Air Mattress



Model : MSLH04
Mobile Trolley

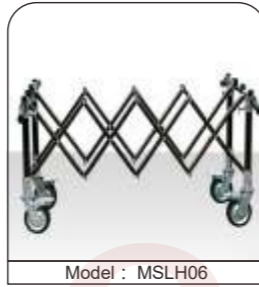

Model : MSLH06
Stretcher Trolley

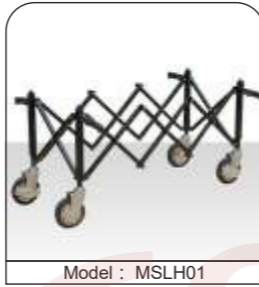

Model : MSLH01
Stretcher Trolley



Model : MSLH08
Rolling Splint



Model : MSLH09
Head Immobilize



Model : MSLH10
Emergency Blanket

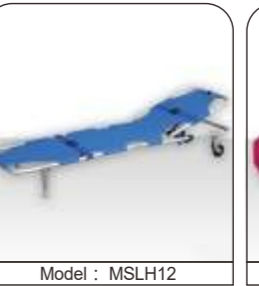

Model : MSLH12
Aluminum Alloy Stretcher



Model : MSLH13
Funeral Stretcher



Model : MSLH24
Rescue Stretcher



Model : MSLH15
Alloy Folding Stretcher

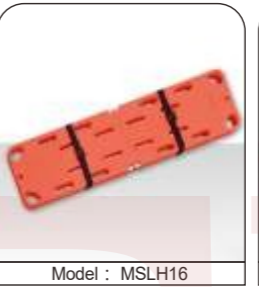

Model : MSLH16
Aluminum Stretcher

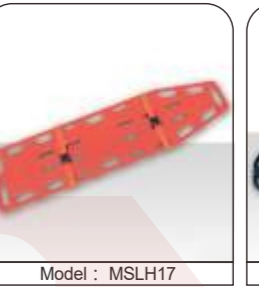

Model : MSLH17
Aluminum Stretcher



Model : MSLH23
Spine Board

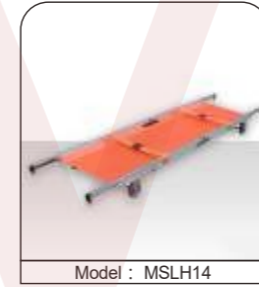

Model : MSLH14
Alloy Stretcher with wheel

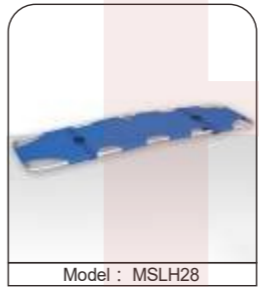

Model : MSLH28
Aluminum Alloy Stretcher

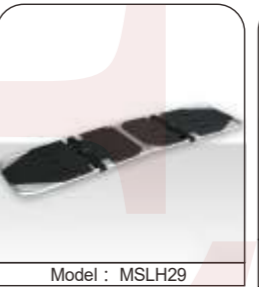

Model : MSLH29
Folding Stretcher

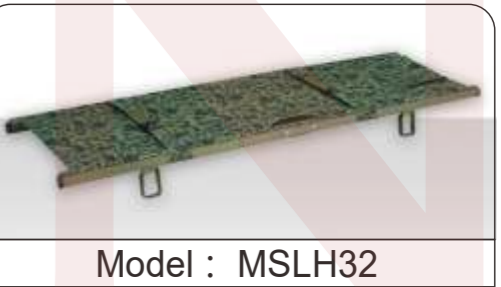

Model : MSLH32
Army Stretcher

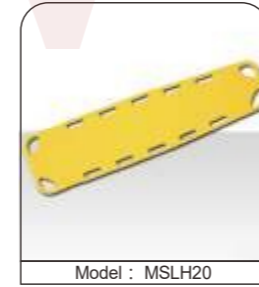

Model : MSLH20
Alloy Folding Stretcher



Model : MSLH34
Folding Stretcher



Model : MSLH35
Stretcher with beckett



Model : MSLH58
Trolley Stretcher



Model : MSLH59
Trolley Stretcher

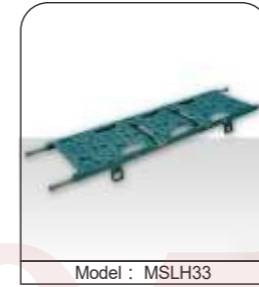

Model : MSLH33
Army Stretcher with wheel



Model : MSLH42
Stretcher With table

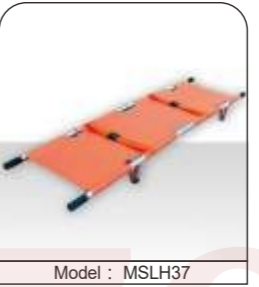

Model : MSLH37
Army Stretcher



Model : MSLH49
Mobile Stretcher



Model : MSLH50
Mobile Stretcher

Medical Furniture

Medical Furniture



Model : MSLH46
Mobile Stretcher



Model : MSLH47
Mobile Stretcher



Model : MSLH53
Trolley Stretcher



Model : MSLH51
Ambulance car



Model : MSLH57
Emergency Car



Model : MSLH64
Emergency bed

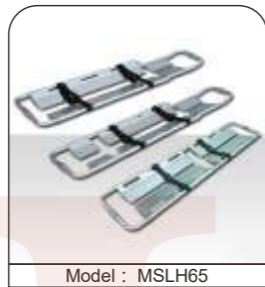

Model : MSLH65
Aluminum Scoop Stretcher



Model : MSLH62
Mobile Stretcher



Model : MSLH68
Aluminum alloy stair Stretcher



Model : MSLH69
Aluminum alloy stair Stretcher



Model : MSLH66
Plastic Scoop Stretcher



Model : MSLH67
Carry sheet



Model : MSLH70
Aluminum alloy stair Stretcher



Model : MSLH71
Aluminum alloy stair Stretcher



Model : MSLH75
Basket Stretcher



Model : MSLH81
Vacuum Stretcher



Model : MSLH82
Extraction Device

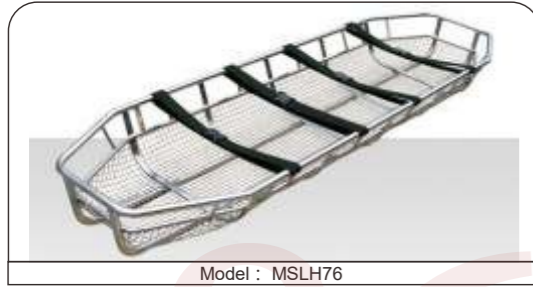

Model : MSLH76
Stainless Basket Stretcher



Model : MSLH85
Traction Splint Set

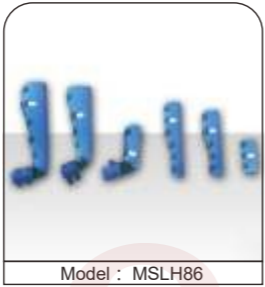

Model : MSLH86
Splint Kit



Model : MSLH87
Air Splint



Model : MSLDH05
Three waiting chair



Model : MSLDH06
single waiting chair



Model : MSLDH07
Three waiting chair



Model : MSLDH03
Waiting chair



Model : MSLDH09
Four waiting chair

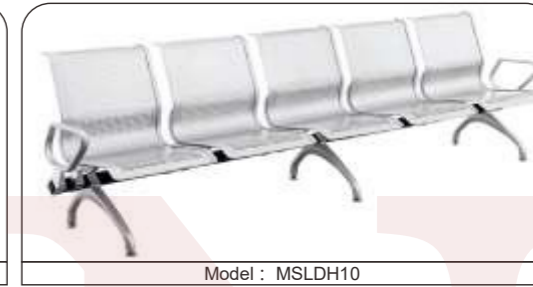

Model : MSLDH10
Five waiting chair

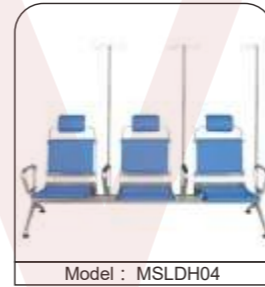

Model : MSLDH04
Three Waiting chair

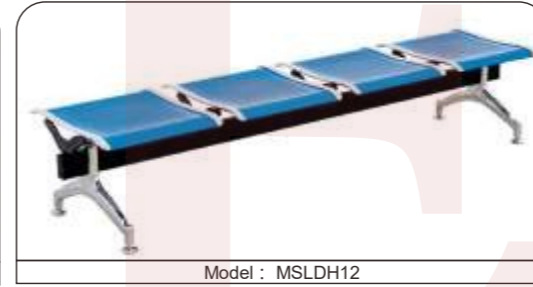

Model : MSLDH12
waiting chair

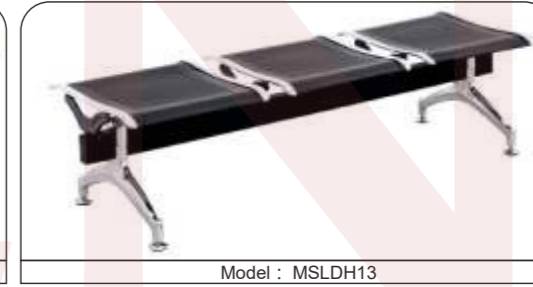

Model : MSLDH13
waiting chair



Model : MSLDH08
Double waiting chair



Model : MSLDH11
Double row waiting chair



Model : MSLLJ01
Hospital garbage can



Model : MSLLJ03
Hospital garbage can

Medical Furniture

Medical Furniture

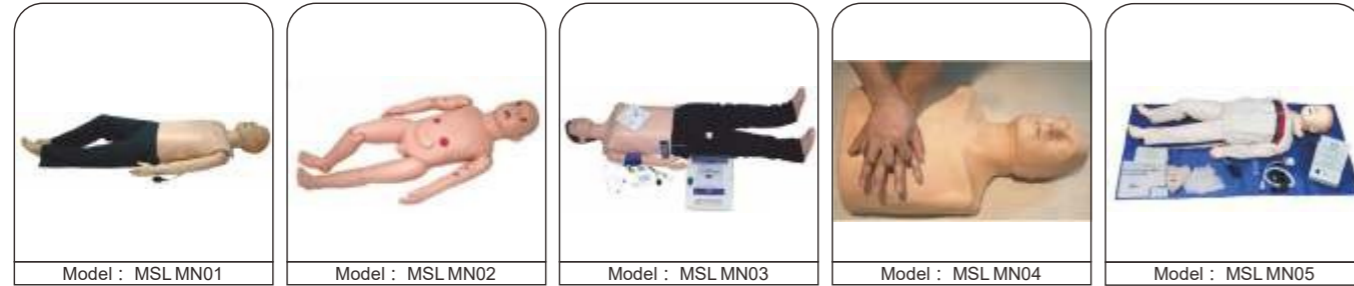

Model : MSL MN01 Emergency care simulator for adult
 Model : MSL MN02 Emergency care simulator for baby
 Model : MSL MN03 Mult function emergency simulator
 Model : MSL MN04 CPR Simulator for adult
 Model : MSL MN05 CPR Simulator for adult

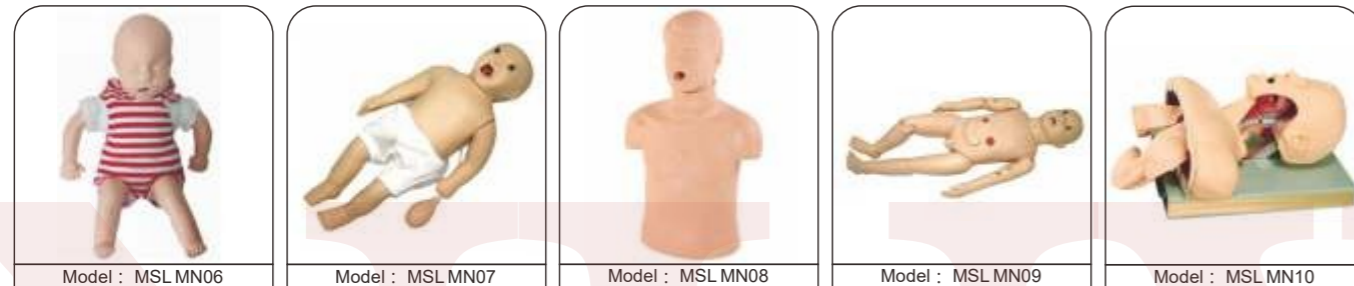

Model : MSL MN06 Baby Simulator
 Model : MSL MN07 Baby Simulator
 Model : MSL MN08 CPR Simulator for adult
 Model : MSL MN09 Senior baby simulator
 Model : MSL MN10 Trachitis simulator

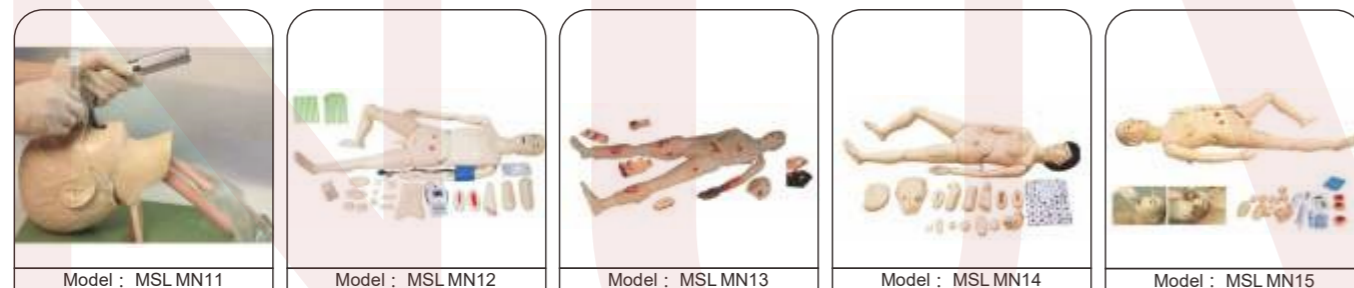

Model : MSL MN11 Trachitis simulator for child
 Model : MSL MN12 Adult simulator
 Model : MSL MN13 Trauma nursing simulator
 Model : MSL MN14 Trauma nursing simulator
 Model : MSL MN15 Trauma nursing simulator for elder

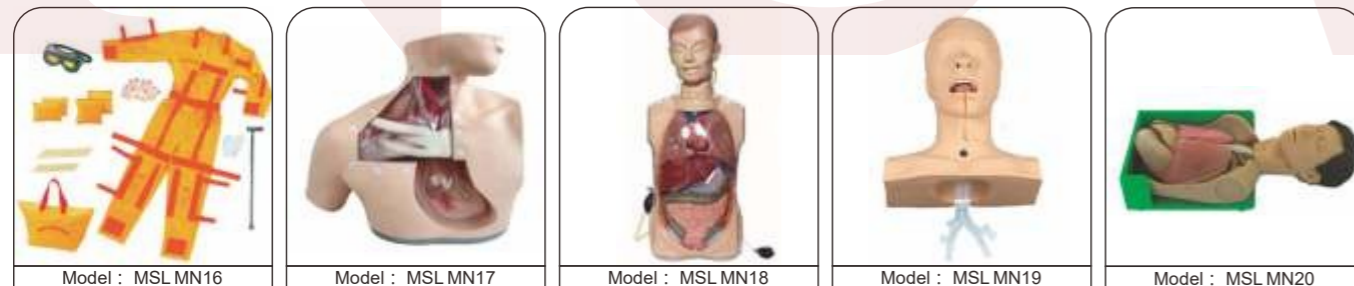

Model : MSL MN16 Simulator for elder
 Model : MSL MN17 Nutrition care simulator
 Model : MSL MN18 Gastric lavage simulator
 Model : MSL MN19 Sputum suction simulator
 Model : MSL MN20 GI decompression simulator

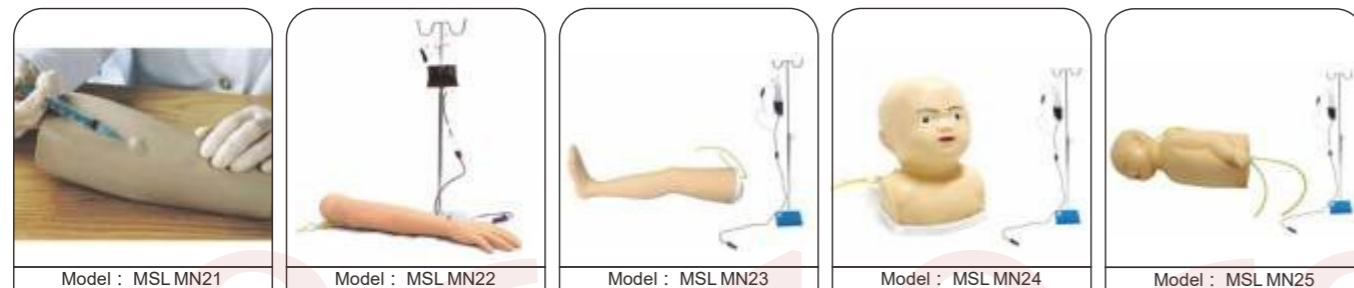

Model : MSL MN21 Arm injection simulator
 Model : MSL MN22 Intravenous injection simulator
 Model : MSL MN23 Leg injection simulator
 Model : MSL MN24 Baby head injection simulator
 Model : MSL MN25 Baby arm injection simulator

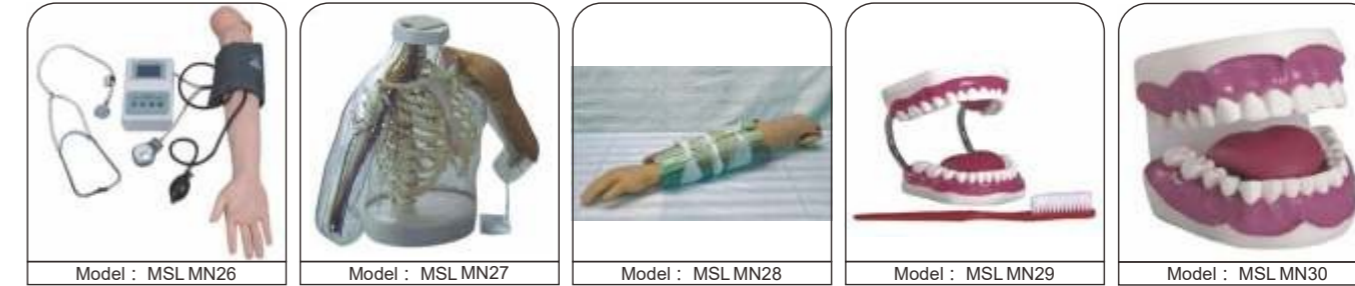

Model : MSL MN26 Blood pressure simulator
 Model : MSL MN27 Intramuscular injection simulator
 Model : MSL MN28 Fracture simulator
 Model : MSL MN29 Dental simulator
 Model : MSL MN30 Dental simulator

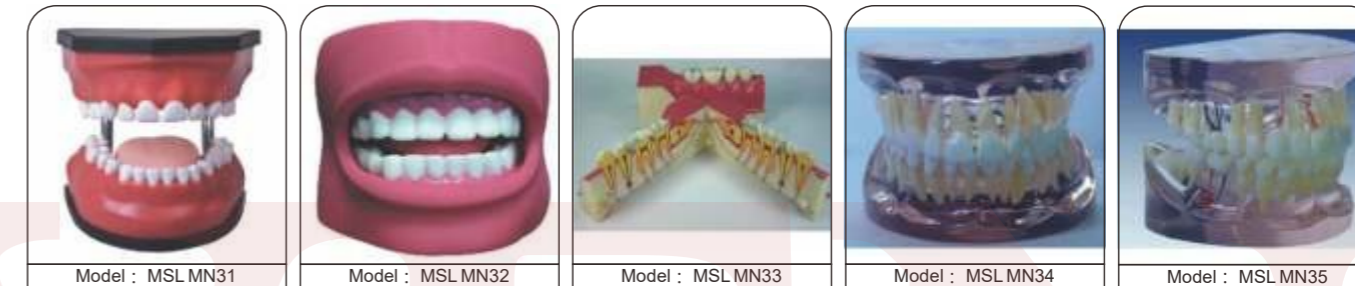

Model : MSL MN31 Dental simulator
 Model : MSL MN32 Dental simulator
 Model : MSL MN33 Dental simulator
 Model : MSL MN34 Dental simulator
 Model : MSL MN35 Dental simulator

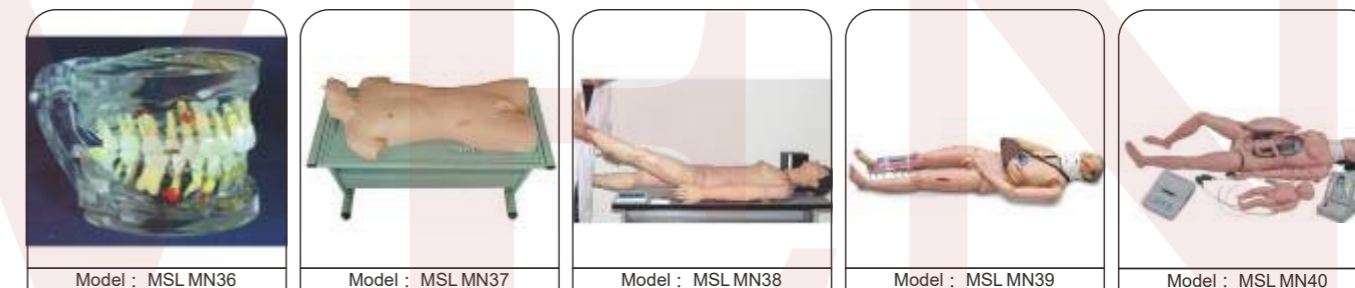

Model : MSL MN36 Dental simulator
 Model : MSL MN37 Paracentesis simulator
 Model : MSL MN38 Slipped disc simulator
 Model : MSL MN39 Fracture fixation simulator
 Model : MSL MN40 Delivery simulator



Model : MSL MN41 Human skeleton simulator 180 cm
 Model : MSL MN42 Human skeleton simulator 180 cm
 Model : MSL MN43 Human skeleton simulator 180 cm
 Model : MSL MN44 Human anatomy simulator
 Model : MSL MN45 Human muscle simulator

Anthropometric Dummy

Anthropometric Dummy



Model : MSLSF04
treatment tables

Model : MSLSF02
treatment tables

Model : MSLSF12
treatment tables

Model : MSL290
Tilt Table



Model : MSLSF44
Combined Cushion



Model : MSLSF28
Boating Exerciser

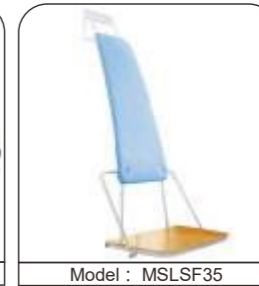

Model : MSLSF35
Chest and Back Straightener



Model : MSLSF30
Arc Abdominal Muscle Exercise



Model : MSLSF16
treatment tables



Model : MSLSF22
treatment tables



Model : MSL297
Upper Limb CPM(for wrist)



Model : MSL298
Lower Limb CPM



Model : MSLSF55
Iron Rod Flashboard



Model : MSLSF31
Hemiplegia Rehabilitation Device



Model : MSLSF48
Grid Correction Mirror



Model : MSLSF32
Wall Bars

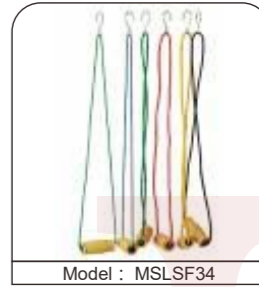

Model : MSLSF34
Power Exercise Elastic Band



Model : MSLSF20
treatment tables



Model : MSL295
Intelligent lower limb feedback rehabilitation training system



Model : MSL302
Upper Limb CPM(for elbow)



Model : MSLSF38
Multifunctional Trainer (four-piece suit)



Model : MSLSF39
Multifunctional Trainer (seven-piece suit)



Model : MSLSF61
Frosted Glass

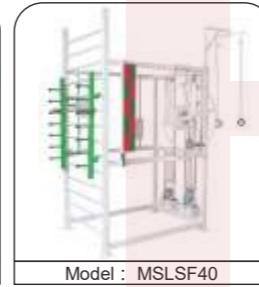

Model : MSLSF40
Multifunctional Trainer (eight-piece suit)



Model : MSLSF37
Pulley Weights



Model : MSLSF53
Digitate Board (arc)

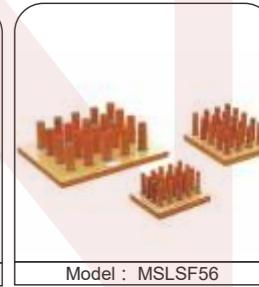

Model : MSLSF56
Wooden Flashboard



Model : MSL299
Upper Limb CPM



Model : MSL296
Intelligent lower limb feedback rehabilitation training system



Model : MSLSF26
Lower Limbs Power Bike (sitting)(Magnetic Damping)



Model : MSLSF27
Boating Exerciser



Model : MSL305
Lower Limb CPM (pediatric)



Model : MSLSF50
Exercise Device



Model : MSLSF51
Relaxation Massager



Model : MSLSF52
Digitate Board



Model : MSLSF85
Screws Board



Model : MSLSF69A
Fingers Ladders



Model : MSL306
passive and active exerciser for upper and lower limb



Model : MSLSF29
Horse Riding Trainer

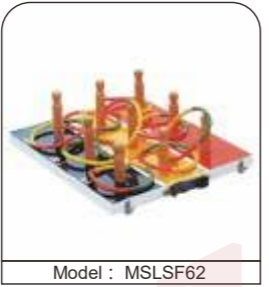

Model : MSLSF62
Quoits



Model : MSLSF64
Hitch Color Plates



Model : MSLSF67
Traction Net Frame



Model : MSLSF70
Fingers Inserting Balls Device



Model : MSLSF73
OT Desk (adjustable)



Model : MSLSF77
Balance Board (with handrail)



Model : MSLSF68
Traction Net Frame



Model : MSLSF82 OT Combined Trainer
 Model : MSLSF78 Upper Limbs Coordination training chair
 Model : MSLSF84 Simulation Job Tools
 Model : MSLSF59 Quoits(vertical)
 Model : MSLSF92 Pedometer

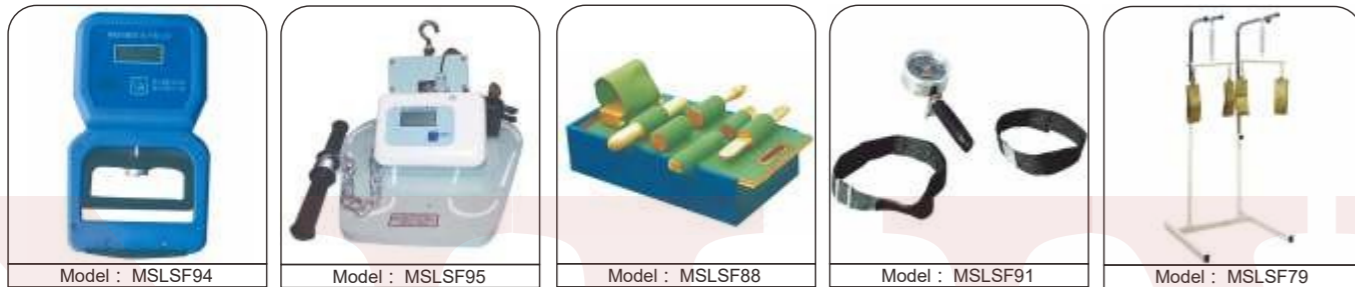

Model : MSLSF94 Hand Dynamometer
 Model : MSLSF95 Back Strength Measurer (electronic display)
 Model : MSLSF88 Waist Function Trainer
 Model : MSLSF91 Multifunctional Joint Motion Goniometer
 Model : MSLSF79 Upper Limbs Hanging Frame



Model : MSLSF104 Electric Lifting Toilet Chair
 Model : MSLSF144 Elbow Joints electrical Traction Chair
 Model : MSLSF145 A Series of Dumbbells
 Model : MSLSF113 Mobile patient transfer hoist
 Model : MSLSF115 Wheelchair Lifting Device for Vehicle
 Model : MSLSF116 Vertical Platform Lifting Machine
 Model : MSLSF112 Speech Training Cards



Model : MSLSF151 Limbs Rehabilitation Device
 Model : MSLSF148 Weight Fingers Power Exerciser
 Model : MSLSF149 Limbs Rehabilitation Device
 Model : MSLSF114 Hydrotherapy Lifting Device
 Model : MSLSF155 Coxa Training Device

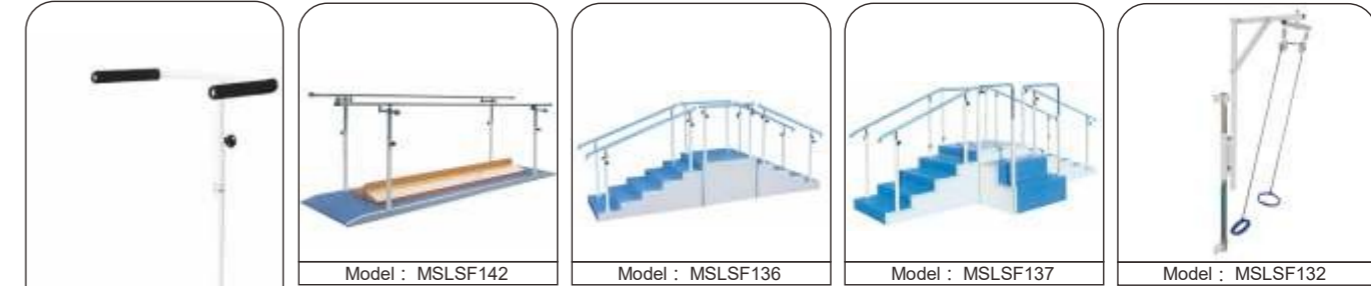

Model : MSLSF142 Parallel Bars(with correction panel)
 Model : MSLSF136 Training Ladder
 Model : MSLSF137 Training Ladder
 Model : MSLSF132 Pulley Rings Exerciser



Model : MSLSF120 Anklebone Rectification Trainer
 Model : MSLSF156 Anklebone Training Device
 Model : MSLSF121 Anklebone Trainer
 Model : MSLSF158 Anklebone Training Device
 Model : MSLSF159 Step Trainer



Model : MSLSF165 Walk Training Aid(fold)
 Model : MSLSF161 Luxury hydraulic stepping trainer
 Model : MSLSF163 Walk Training Aid (with brake and seat)
 Model : MSLSF177 Gait training system



Model : MSLSF307 Multi-joint active and passive training device
 Model : MSLSF124 Shoulder Joint Convolution Training Exerciser(Wheel type, Shoulder Joint Rehabilitation Trainer)
 Model : MSLSF314 Passiveandactiveexerciser forupperandlowerlimb
 Model : MSLSF175 Multipurpose Standing Training Device
 Model : MSLSF316 Limb linkage rehabilitation training device



Model : MSLJC01
Operating knife hold



Model : MSLJC02
Surgical blade



Model : MSLJC03
Surgical scissors



Model : MSLKF08
Fracture fixing clamp



Model : MSLKF05
Clamp forces



Model : MSLKF06
Department of orthopedics retractor



Model : MSLKF07
Department of orthopedics retractor



Model : MSLJC04



Model : MSLJC12
Gauze bandage scissors



Model : MSLJC11
Small vessel scissors



Model : MSLKF20
Screw slippage extractor



Model : MSLKF09
Periosteal dissector

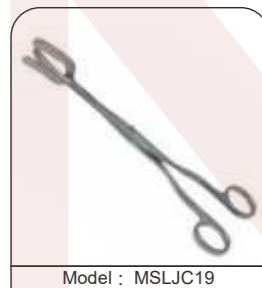

Model : MSLJC19
Instrument forceps



Model : MSLJC20
Foreign forceps

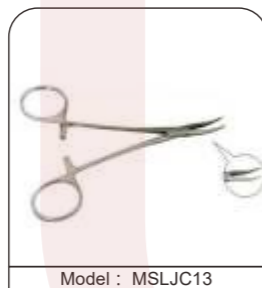

Model : MSLJC13
Hemostatic forceps

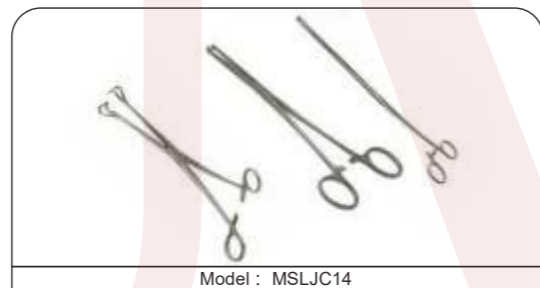

Model : MSLJC14
Tissue forceps



Model : MSLKF11
Knee boen pry

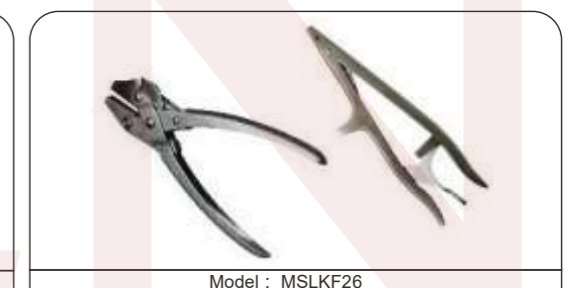

Model : MSLKF26
Ovarian forceps



Model : MSLJC37
Ophthalmic forceps



Model : MSLJC27
Ear forceps

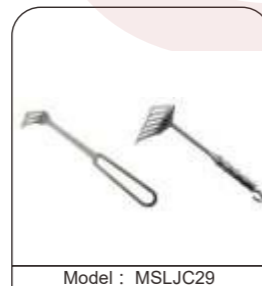

Model : MSLJC29
Wound hook

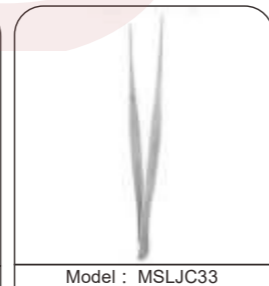

Model : MSLJC33
Thoracic forceps



Model : MSLJC34
Cut-off knife



Model : MSLKF21
Broken nail extractor



Model : MSLKF18
Steel plate bending hand



Model : MSLKF19
Screwdriver



Model : MSLJC31
Tissue forceps



Model : MSLJC32
Fine forceps



Model : MSLJC23
Peritoneal forceps



Model : MSLKF16
Tap



Model : MSLKF14
Bone traction needle

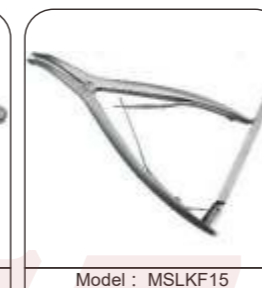

Model : MSLKF15
Department of orthopedics bit



Model : MSLKF25
Obstetric forceps



Model : MSLKF32
Vaginal retractor



Model : MSLKF33
Double wing vaginal dilator

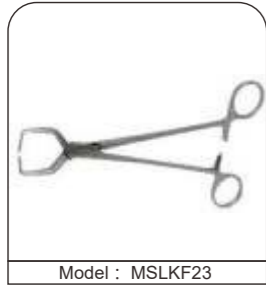

Model : MSLKF23
Umbilical cord scissors



Model : MSLKF38
Cervical dilator



Model : MSLKF36
Pelvic gauge



Model : MSLFK04
Tie wire



Model : MSLEBH01
Tuning fork



Model : MSLEBH03
Micro ear forceps



Model : MSLEBH44
Maxillary sinus hemostat

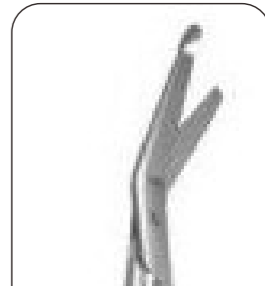

Model : MSLFK17
Gynecological scissors



Model : MSLKF42
Hand bone drill



Model : MSLKF43
Bone file

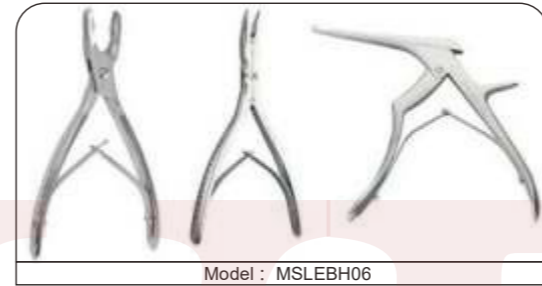

Model : MSLEBH06
Mastoid retractor

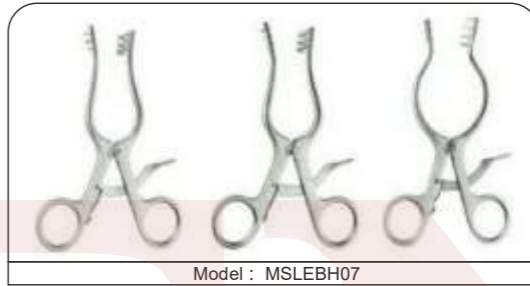

Model : MSLEBH07
Mastoid retractor



Model : MSLKF30
Cervical biopsy forceps

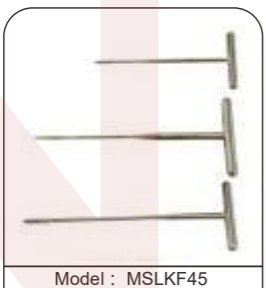

Model : MSLKF45
Wire threading device

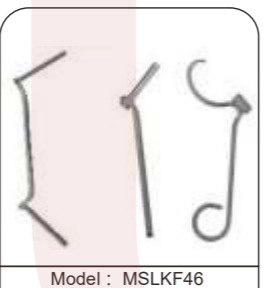

Model : MSLKF46
Ligature pliers for steel wire



Model : MSLKF47
Depth finder

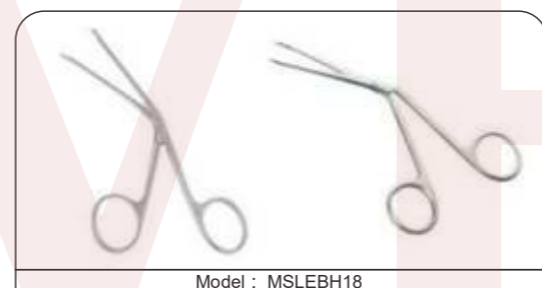

Model : MSLEBH18
Other ear instruments



Model : MSLEBH16
Suction tube for ear



Model : MSLEBH13
Cerumen hook

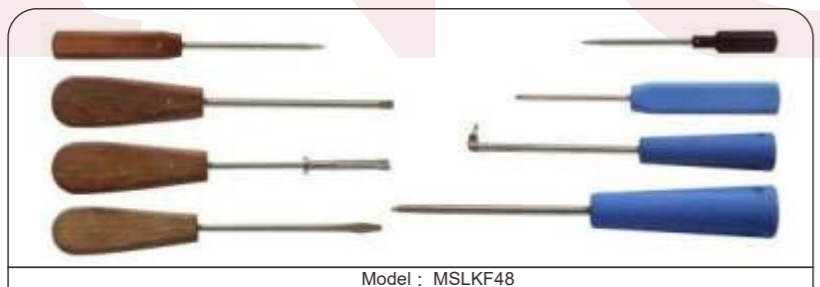

Model : MSLKF48
Phalanx saw



Model : MSLFK10
Upper limb joint bone pry

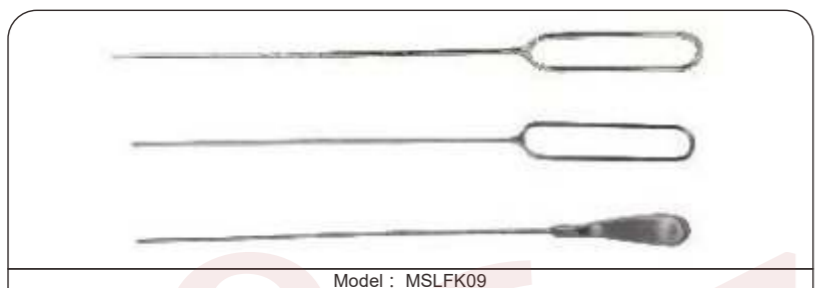

Model : MSLFK09
Double joint bone shears

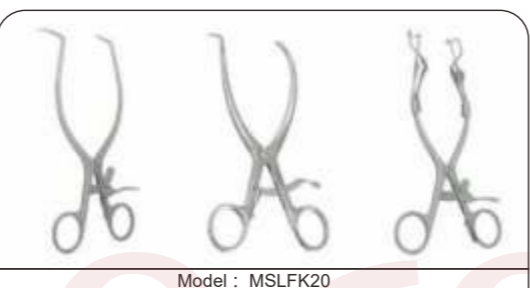

Model : MSLFK20
Perineal retractor



Model : MSLFK22
Uterine scissors



Model : MSLFK23
Fallopian tube through device



Model : MSLFK21
Vaginal ring scissors



Model : MSLFK25
Silicong rubber fetal aspirator



Model : MSLFK26
Stripper

Orthopedic Instruments

Gynecological instruments

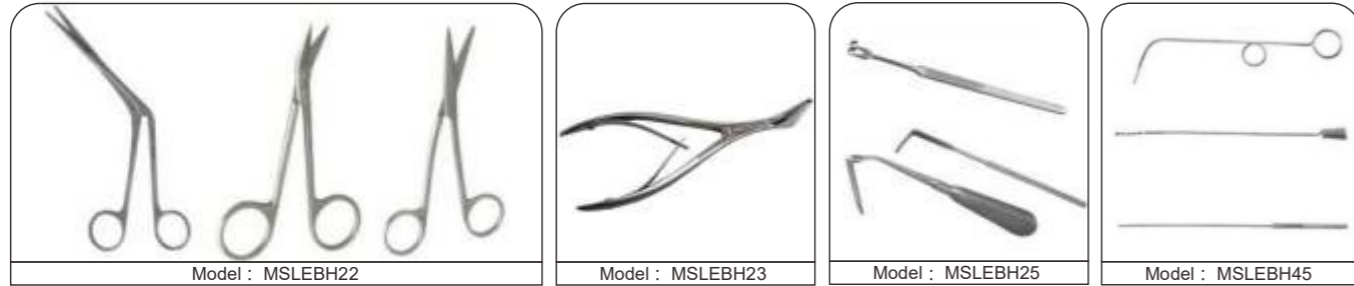

Model : MSLEBH22 Model : MSLEBH23 Model : MSLEBH25 Model : MSLEBH45
Nasal scissors Nasal speculum Nasal retractor Cotton applicator



Model : MSLEBH26 Model : MSLEBH30 Model : MSLEBH31
Nasal mucosa knife Sampling tongs Nasal dissector

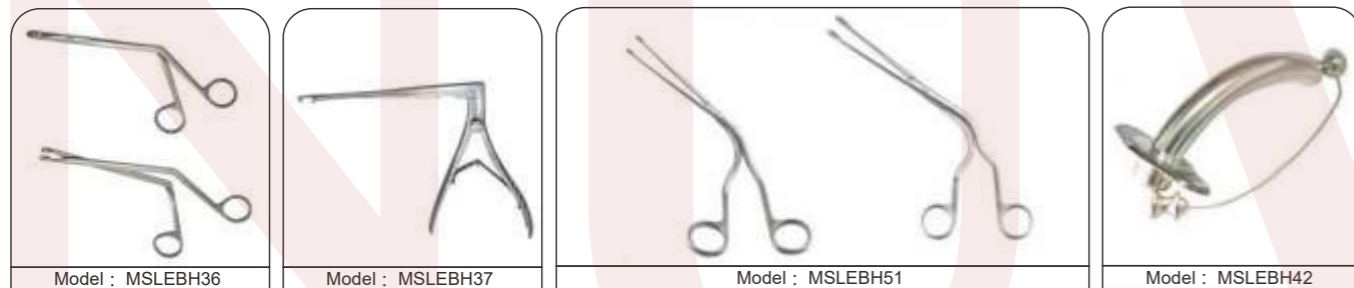

Model : MSLEBH36 Model : MSLEBH37 Model : MSLEBH51 Model : MSLEBH42
Nasal polypus forceps Maxillary sinus rongeur Tracheal catheter forceps Tracheal cannula



Model : MSLEBH43 Model : MSLEBH53 Model : MSLEBH58 Model : MSLEBH59
Nasal septum rongeur Tonsil hemostatic forceps Tonsil suction tube Tonsil guillotine



Model : MSLEBH41 Model : MSLEBH60 Model : MSLEBH64 Model : MSLBN15
Nasal septum chisel Tonsil snare Tongue depressor Anal speculum



Model : MSLPW01 Model : MSLBN05 Model : MSLPW03 Model : MSLBN07 Model : MSLBN08
Abdominal suction tube Prostatic retractor Retractor for tissue retractor of feneral surgery Lithotomy forceps KiBhghkto netfamtops

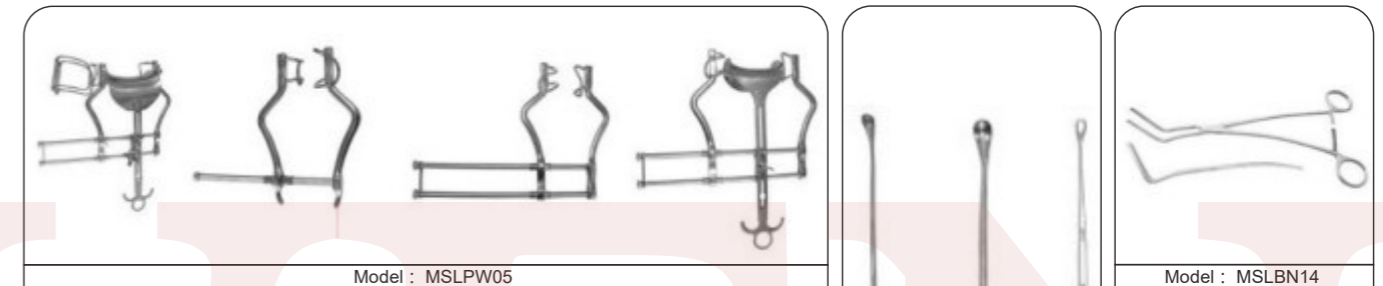

Model : MSLPW05 Model : MSLBN14
Stomach clamp Non destructive slamp forceps

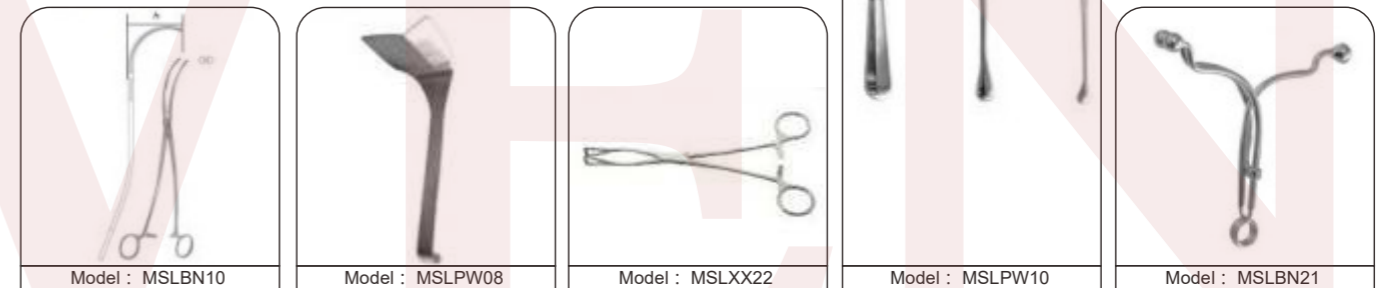

Model : MSLBN10 Model : MSLPW08 Model : MSLXX22 Model : MSLPW10 Model : MSLBN21
Bladder neck forceps Biliary retractor Triangular lobectomy forceps Gallstone scoop Penis clamp



Model : MSLXX16 Model : MSLXX02 Model : MSLXX09
Non traumatic injury vena cave forceps Sternal retractor Scapular retractor

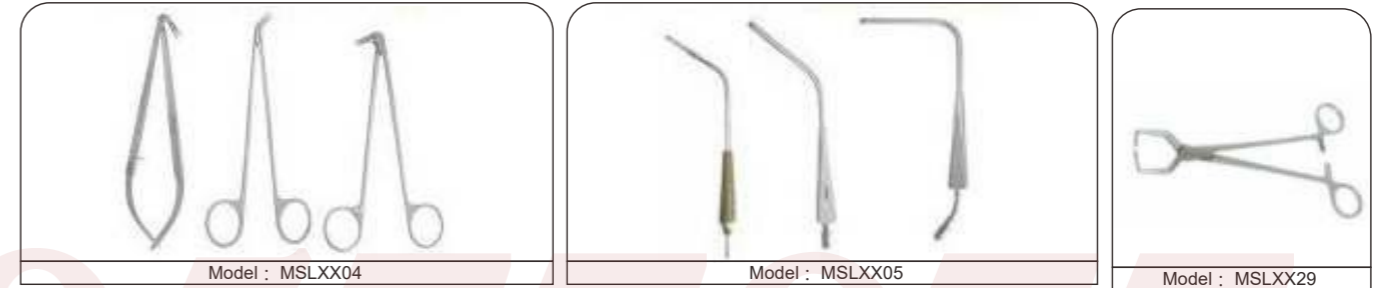

Model : MSLXX04 Model : MSLXX05 Model : MSLXX29
Coronary scissors Thoracic suction tube Punch



Model : MSLXX07
Hemostatic clamp

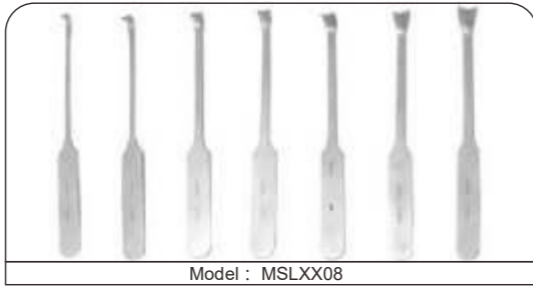

Model : MSLXX08
Ventricular retractor

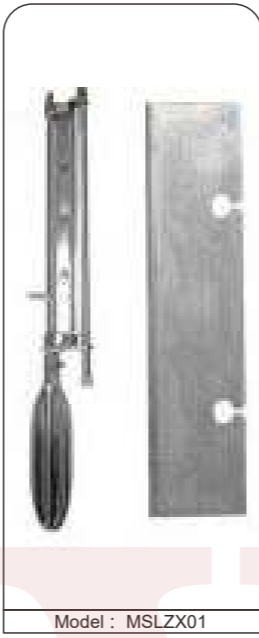

Model : MSLZX01
The value of knife roller shaft

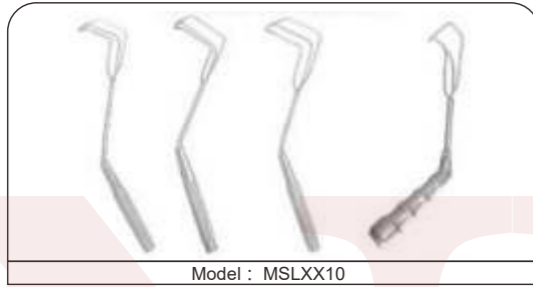

Model : MSLXX10
Atrial retractor

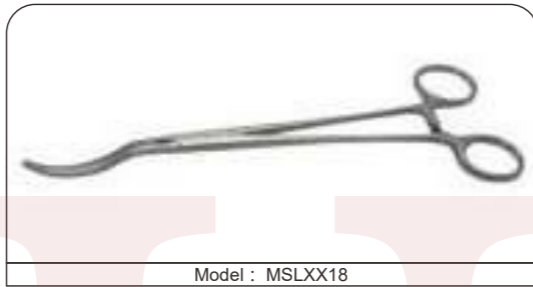

Model : MSLXX18
Non traumatic aortic forceps



Model : MSLXX12
Rib Scissors/forceps



Model : MSLXX23
Forceps

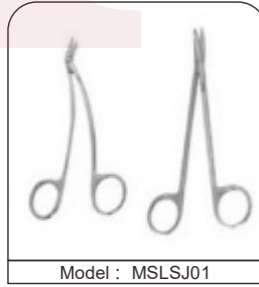

Model : MSLSJ01
Meninges/nerve scissors

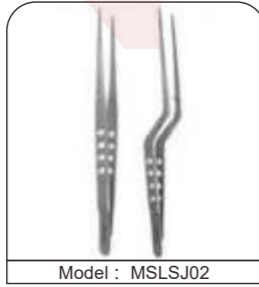

Model : MSLSJ02
Brain forceps



Model : MSLSJ14
Flexible shaft retractor



Model : MSLSJ15
Micro brain scissors

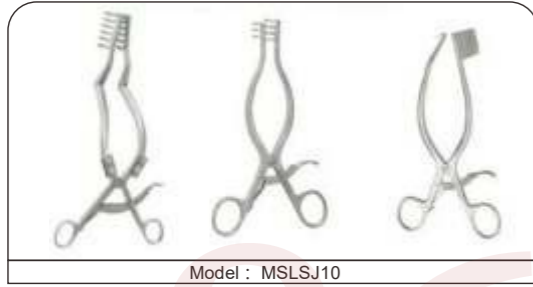

Model : MSLSJ10
Posterior fossa retractor



Model : MSLZX09
Mouth gag



Model : MSLSJ04
Skin retractor



Model : MSLZX03
Plastic forceps

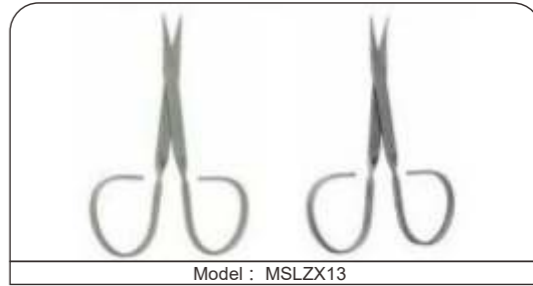

Model : MSLZX13
Ophthalmic scissors



Model : MSLZX14
Micro ophthalmic hook



Model : MSLSJ08
Brain hammer



Model : MSLZX06
Skin retractor

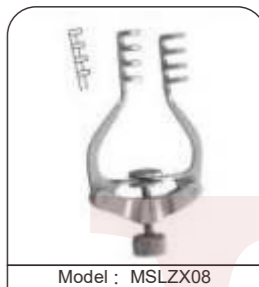

Model : MSLZX08
Brain mastoid retractor



Model : MSLZX19
Nasal septum rongeur

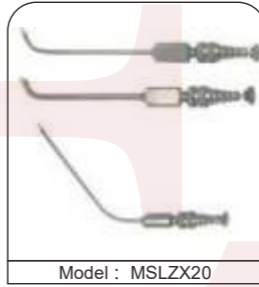

Model : MSLZX20
Nasal suction tube

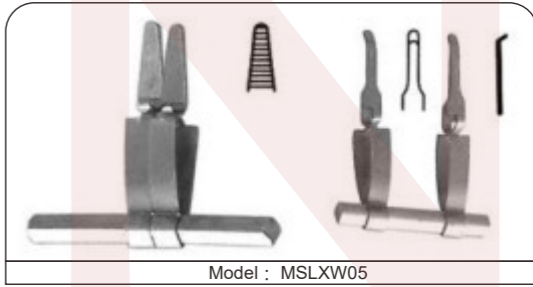

Model : MSLXW05
Micro closure device



Model : MSLZX23
Nasal septum scissors

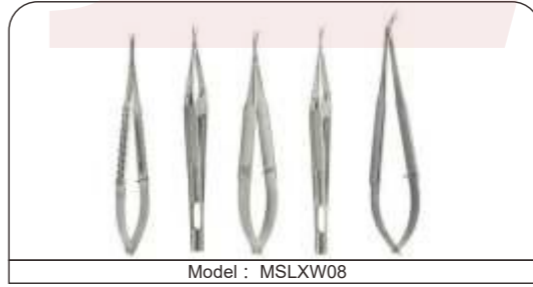

Model : MSLXW08
Micro scissors



Model : MSLZX27
Operating knife holder



Model : MSLZX29
Dimple drill

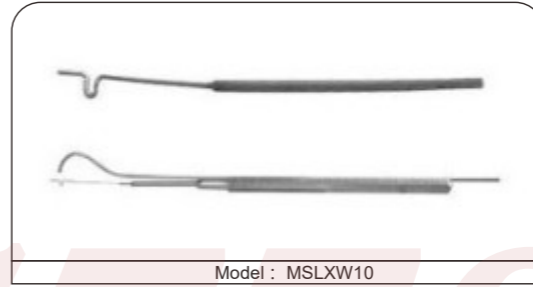

Model : MSLXW10
Microvascular dilator



Model : MSLZX31
Lip clip



Model : MSLXW04
Microvascular hook



Model : MSLXG01

Heparin tube



Model : MSLXG02

Glucose tube



Model : MSLXG03

Citrate tube



Model : MSLXG04

ESR tube



Model : MSLXG19

Gauze Mask

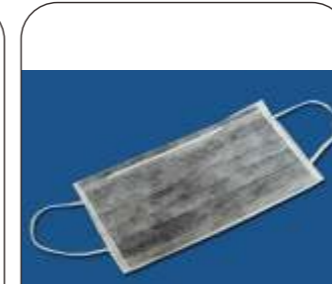

Model : MSLXG20

Activated Charcoal Mask



Model : MSLXG17

Needle Free Syringe



Model : MSLXG18

Veterinary Syringe



Model : MSLXG05

Blood Collection Tube

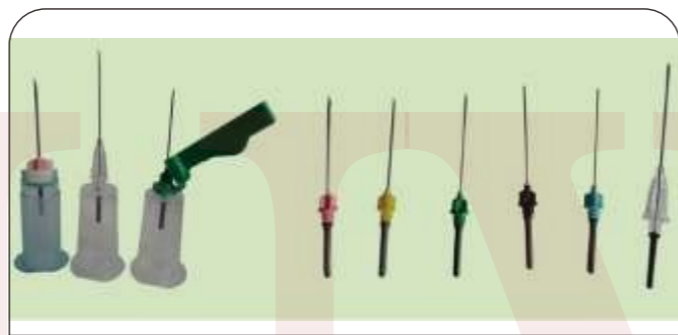

Model : MSLXG06

Blood Taking Needle



Model : MSLXG23

Way Silicone Foley Catheter



Model : MSLXG25

Way Silicone Foley Catheter



Model : MSLXG26

PVC Nelaton Catheter



Model : MSLXG22

Suprapubic SFC



Model : MSLXG07

Safety Syringe



Model : MSLXG08

Blood lancet



Model : MSLXG09

Safety lancet



Model : MSLXG10

Imm lancet



Model : MSLXG27

Pre-Powdered Surgical



Model : MSLXG28

Powder Free Surgical Gloves



Model : MSLXG29

Examination Gloves



Model : MSLXG30

Disposable Cap



Model : MSLXG11

2.5ml Syringe



Model : MSLXG12

5ml Syringe



Model : MSLXG15

50ml Syringe



Model : MSLXG16

Infusion Set



Model : MSLXG31

Guedel Airway



Model : MSLXG32

Berman Guedel Airway

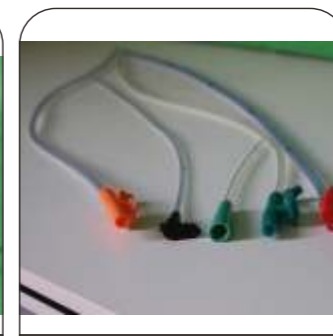

Model : MSLXG33

Berman Guedel Airway



Model : MSLXG34

Silicone Laryngeal Mask Airway



Model : MSLXG35
Silicone Catheter



Model : MSLXG36
PVC endotracheal tube



Model : MSLXG37
Silicone bulbs

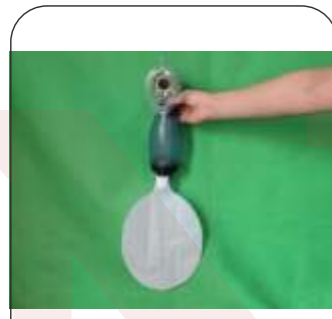

Model : MSLXG38
Silicone resuscitator



Model : MSLXG39
Resuscitator tube



Model : MSLXG40
Resuscitator tube



Model : MSLXG41
Resuscitator tube



Model : MSLXG42
Resuscitator mask



Model : MSLXG43
Resuscitator mask



Model : MSLXG44
Tourniquet



Model : MSLXG45
Oxygen cylinder 4L



Model : MSLXG46
Oxygen cylinder 10L



Model : MSLXG47
Flowmeter



Model : MSLXG48
Paper roll



Model : CC01
cuvette cup



Model : MSLCC02
Surgical gowns



Model : CC03
ENT Drape Pack



Model : CC04
Universal surgery pack

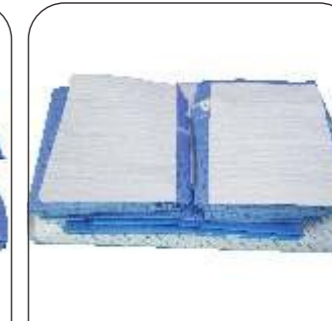

Model : CC05
C-section pack

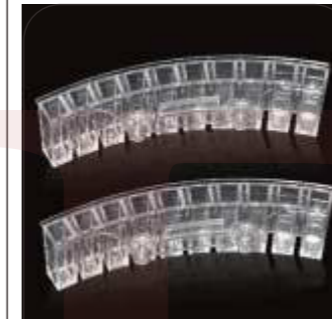

Model : CC06
cuvette cup



Model : CC07
cuvette cup



Model : CC08
cuvette cup



Model : CC16
cuvette cup



Model : CC13
cuvette cup

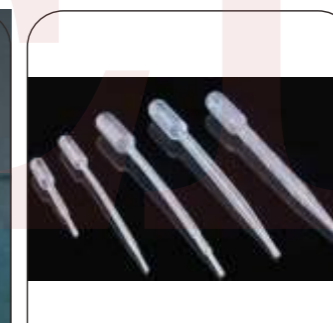

Model : PP01
pasteur pipette



Model : PT03
pipette tips

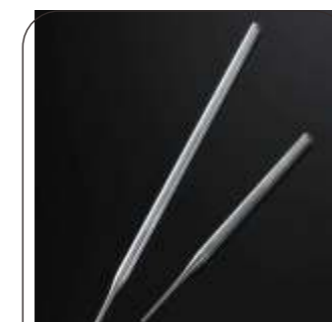

Model : PP03
Transfer pipette



Model : PT01
Pipette Tip



Model : PT07
Pipette Tip Box



Model : CT02
Centrifuge Tube

Medical Consumable

Medical Consumable



Model : CT04
centrifuge cup



Model : CT03
Centrifuge Tube



Model : CT06
Centrifuge Tube



Model : CT07
Centrifuge Tube



Model : TR06
Plastic tube rack



Model : UT11
Urine Cup



Model : UT08
Urine Cup

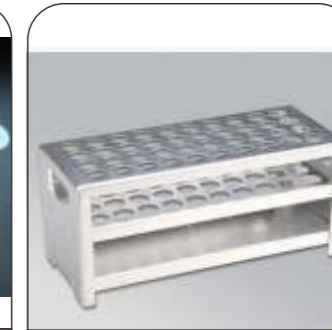

Model : TR11
Stainless steel rack



Model : CT08
Centrifuge Tube



Model : CU01
cryovial tube



Model : CU03
cryovial tube



Model : CU07
cryovial tube



Model : TR02
Plastic tube rack



Model : TR03
Plastic tube rack

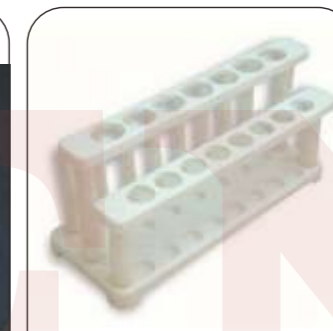

Model : TR08
Plastic tube rack



Model : TR05
Plastic tube rack



Model : SW01
swab



Model : SW02
swab

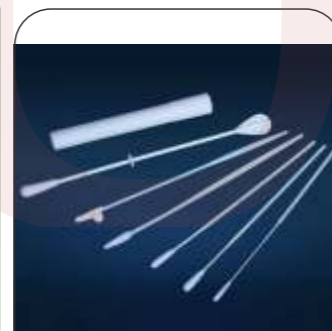

Model : SW03
swab



Model : UT01
Urine Cup



Model : MS05
Slides

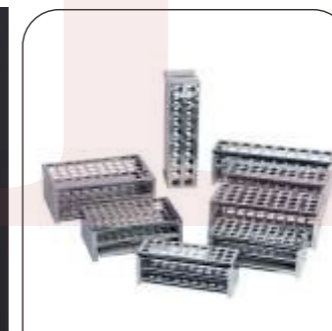

Model : TR12
Stainless steel rack



Model : TR13
tube rack



Model : MS04
Slides



Model : PD01
Petri dish



Model : PD02
Petri dish



Model : UT02
Urine Cup



Model : UT06
Urine Cup



Model : MS02
Color slides



Model : MS03
Slides



Model : VS01
vaginal speculum



Model : VS02
vaginal speculum

Medical Consumable

Medical Consumable

86-18680579



Model : VS04
vaginal speculum



Model : UB03
Blood Bag



Model : UB05
Urine bag



Model : UB06
Urine bag



Model : MT01
Needle Holder



Model : MT02
Blood Taking Needle



Model : MT03
Blood Taking Needle



Model : ST01
Blood Taking Needle



Model : UB07
Urine bag



Model : BA01
Band-Aids



Model : CS01
Cervical Scraper



Model : FT02
Blood Pressure Sensor



Model : ST02
Blood Taking Needle

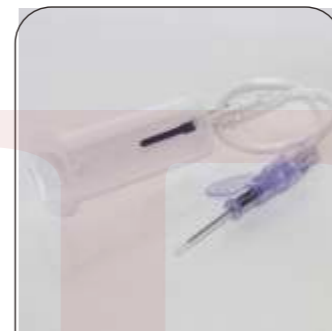

Model : SC01
Blood Taking Needle



Model : SC02
Blood Gas Syringe



Model : SC03
Petri dish

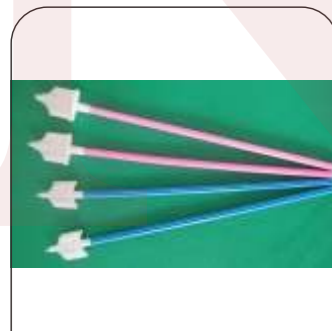

Model : CS03
Cervical Scraper



Model : CS04
Cervical Scraper



Model : FT01
Feeding tube



Model : MG04
Medical gypsum



Model : S01
Petri Dish



Model : S02
Medium

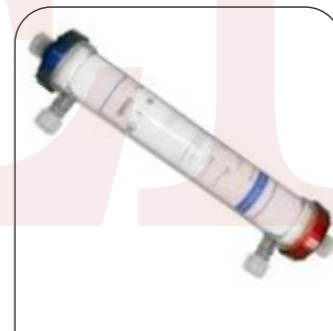

Model : HF03
hemodialysis filter



Model : NS06
needle suture 1



Model : MG01
Medical gauze



Model : M02
Medical gauze



Model : MG03
Bandage



Model : MG04
Gauze Bandage



Model : EC01
embedding cassette



Model : UC02
Disposable Trocars



Model : UC03
central venous catheter kit



Model : UC04
hemodialysis catheter

Medical Consumable

Medical Clothing



Model : ST11
Medical tape



Model : ST12
Medical tape



Model : AT13
Medical tape



Model : ST14
Stomach tube



Model : ST15
Stomach tube

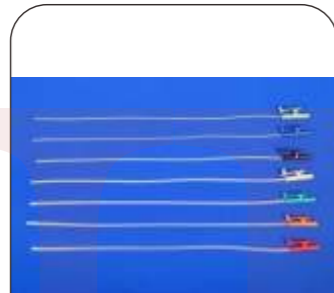

Model : SC07
Suction catheter



Model : SC08
Suction catheter



Model : SC09
Suction catheter



Model : S01
Swab



Model : S02
Swab



Model : TD01
tongue depressor



Model : TD02
tongue depressor

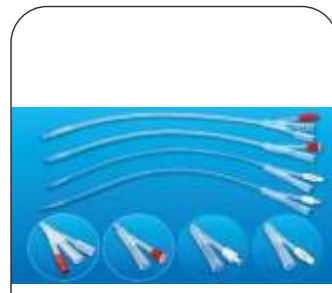

Model : UC01
urethral catheter



Model : UC02
urethral catheter



Model : UC03
Arterial Venous Fistula Set



Model : UC04
Catheterization Set



Model : MSL YF01
Doctor clothes long sleeve



Model : MSL YF02
Nurse clothes long cleve



Model : MSL YF03
Dortoe clothes



Model : MSL YF04
Dortoe clothes



Model : MSL YF05
Surgical clothes



Model : MSL YF06
Surgical clothes



Model : MSL YF07
Surgical clothes



Model : MSL YF08
Nurse clothes



Model : MSL YF09
Nurse clothes



Model : MSL YF10
Vest



Model : MSL YF11
Long nurse



Model : MSL YF12
Nurse sweater



Model : MSL YF13
Nurse sweater



Model : MSL YF14
Protective suit



Model : MSL YF15
Protective suit



Model : MSL YF16
Patient clothes



Model : MSL YF17
Patient clothes



Model : MSL YF18
Nurse cap



Model : MSL YF19
Nurse cap



Model : MSL YF20
Nurse sheet



Model : MSL YF21
Bed sheet



Model : MSL YF22
Nurse sheet



Model : MSL YF23
Nurse sheet