





NUWEN CO.,LTD

**ADD:UNIT 1,NO.187,XIAYANG ROAD,HETANG TOWN PENGJIANG,
DISTRICT,JIANGMEN CITY,GUANGDONG, PROVINCE,CHINA.**

NUWEN PARTY,WEDDING & HOLIDAY TENT CATLOUGE

 **MOBILE:+86-18680577977**

 **E-EMAIL:1146156552@QQ.COM**

 **WECHAT/WHATS APP:+86-18680577977**



NUWEN CO.,LTD



Item 名称	Specification 规格
Clear-span width 篷房跨度	3m/4m/5m
Eave height 屋檐高度	2.6m
Ridge height 屋脊高度	3.1m/3.3m/3.5m
Roof pitch 屋面坡度	18°
Bay distance 单元间距	3m
Longest component 最长部件	3.0m/4.0m/5.0m
Minimum tent length 最少起订	6m
Roof fixing 屋面固定	Rubber tensioning 拉紧器
Main profile 主型材	82x48x3mm(2-channel)
Max. allowed wind speed 最高承受抗风	80km/hour 0.3kn/m ²
Eave/Ridge connection 屋檐/屋脊连接角	Hot-dip Galvanized steel insert 镀锌钢铁
Framework material 框架材料	Hard pressed extruded Aluminium 6061-T6 硬挤压铝合金 6061-T6 (13HW)
Cover material 屋面材料	Waterproof, fireproof(DIN4012 B1, M2), UVresistant 防腐、防霉、抗紫外线、阻燃 (M2和B1) 等性能达到国际标准

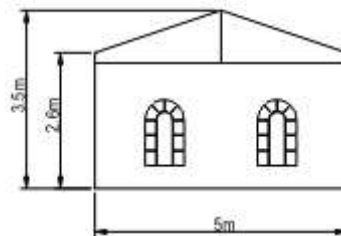
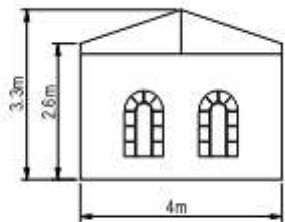
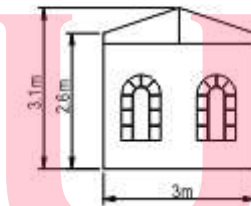
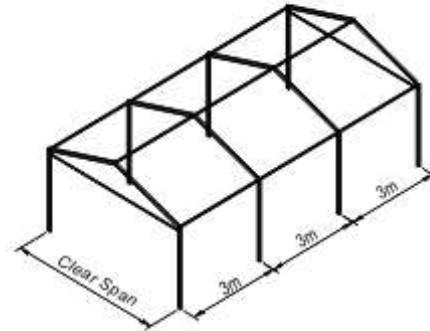

Optional accessories

- | | |
|------------------------------------|-----------|
| PVC window sidewalls | PVC侧边围布 |
| Glass door units | 玻璃门 |
| Anchoring | 膨胀螺丝 |
| Transparent PVC cover and sidewall | 透明PVC墙和墙壁 |
| Rain Gutter | 雨水槽 |
| Flooring system | 地台 |
| Lining and curtain | 窗帘和围幔 |
| Weight plate | 称重盘 |

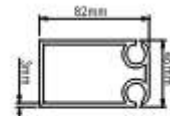

Roof Beam, Upright Support, Gable Pole
顶梁、立柱、端面柱子

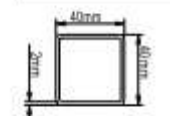

Eave Purlin, Intermediate Purlin, Ridge Purlin
屋檐方管、屋面方管、屋脊方管



Sidewall downside bar
墙底压布杆

Framework main profile dimension and use

框架主型材尺寸及使用

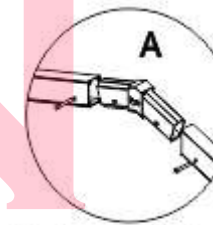
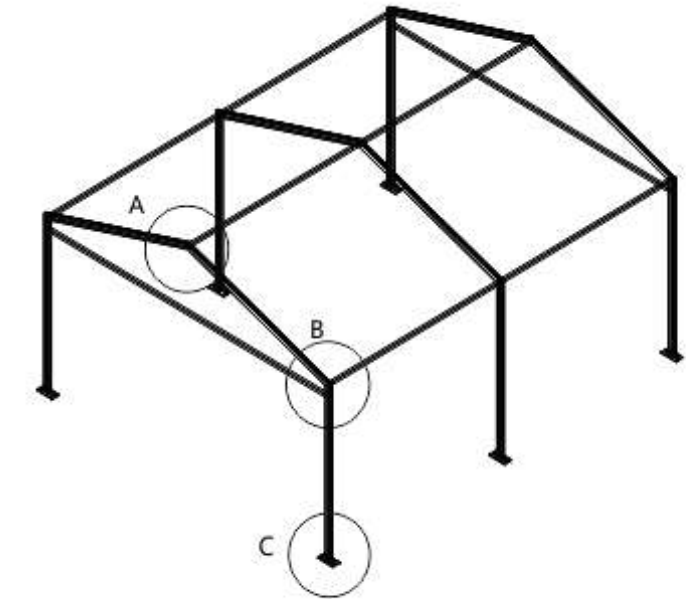

ridge head connection(gable end)
顶角链接

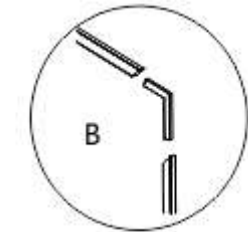

eave corner(field)
屋檐链接

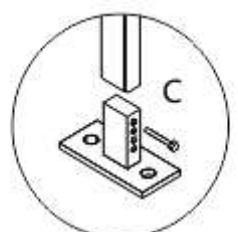

baseplate(field)
底座链接



2011/06/28

+86-18680577977



Item 名称	Specification 规格
Clear-span width 篷房跨度	6m/8m/10m/12m
Eave height 屋檐高度	2.6m
Ridge height 屋脊高度	3.7m/4.0m/4.4m/4.8m
Roof pitch 屋面坡度	20°
Bay distance 单元间距	5m
Longest component 最长部件	3.7m/4.2/6.4m
Minimum tent length 最少起订	6m
Roof fixing 屋面固定	Rubber tensioning 拉紧器
Main profile 主型材	122x68x3mm(2-channel)
Max. allowed wind speed 最高承受抗风	80km/hour 0.3kn/m ²
Eave/Ridge connection 屋檐/屋脊连接角	Hot-dip Galvanized steel insert 镀锌钢铁
Framework material 框架材料	Hard pressed extruded Aluminium 6061-T6 硬挤压铝合金 6061-T6 (13HW)
Cover material 屋面材料	Waterproof, fireproof(DIN4012 B1, M2), UVresistant 防腐、防霉、抗紫外线、阻燃(M2和B1)等性能达到国际标准

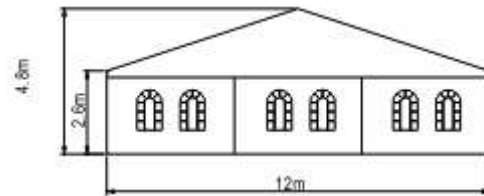
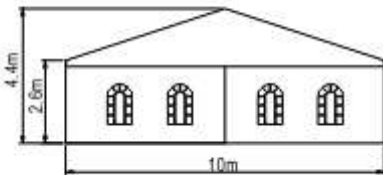
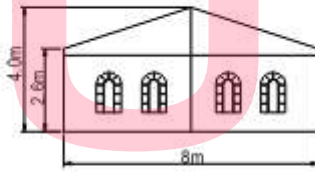
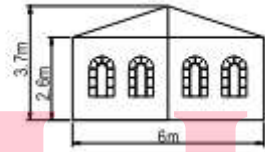
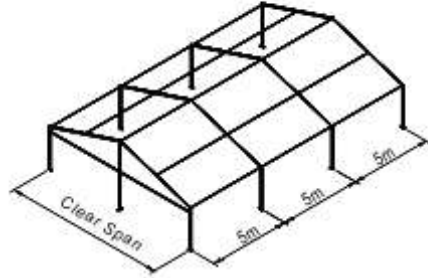

Optional accessories

- PVC window sidewalls PVC侧边围布
- Glass door units 玻璃门
- Anchoring 膨胀螺丝
- Transparent PVC cover and sidewall 透明PVC墙和墙壁
- Rain Gutter 雨水槽
- Flooring system 地台
- Lining and curtain 窗帘和围幔
- Weight plate 称重盘
- Hard walling system 硬体墙系统
- Glass walling system 玻璃墙系统

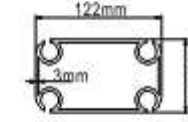

Roof Beam, Upright Support, Gable Pole
顶梁、立柱、端面柱子

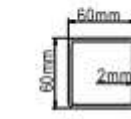

Eave Purlin, Gable pole, Ridge Purlin
Intermediate Purlin
屋檐梁、端面横梁、屋脊梁
屋面方管



Sidewall downside bar
墙底压布杆

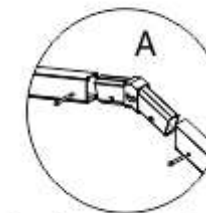
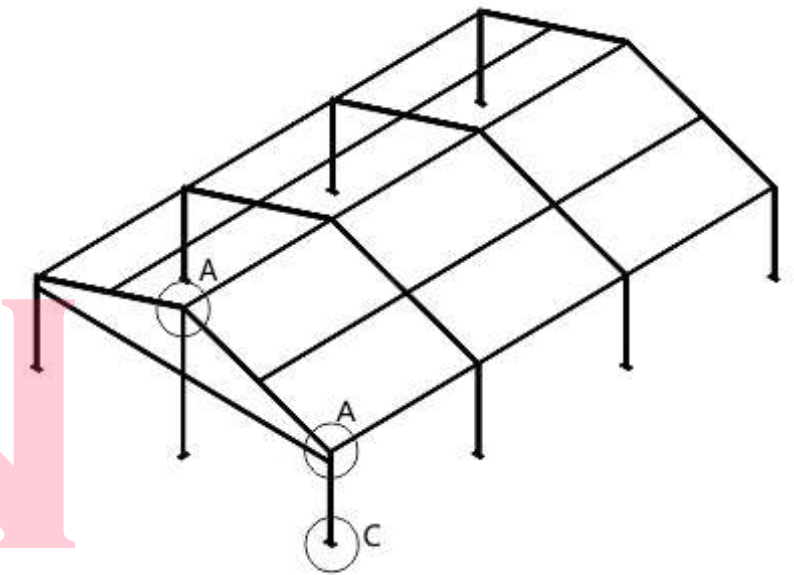

ridge head connection(gable end)
顶角链接

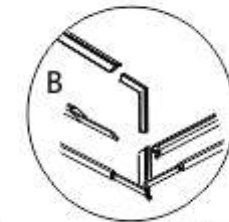

eave corner(field)
屋檐链接

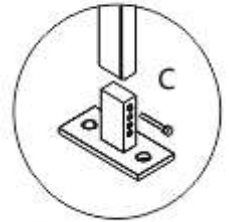

baseplate(field)
底座链接





Item 名称	Specification 规格
Clear-span width 篷房跨度	6m/9m/12m/15m
Eave height 屋檐高度	2.6m
Ridge height 屋脊高度	3.6m/4.2m/4.8m/5.3m
Roof pitch 屋面坡度	20°
Bay distance 单元间距	3m
Longest component 最长部件	3.6m/4.2m/4.8m/5.3m
Minimum tent length 最少起订	9m
Roof fixing 屋面固定	Rubber tensioning 拉紧器
Main profile 主型材	120x68x3mm(2-channel)
Max. allowed wind speed 最高承受抗风	80km/hour 0.3kn/m ²
Eave/Ridge connection 屋檐/屋脊连接角	Hot-dip Galvanized steel insert 镀锌钢铁
Framework material 框架材料	Hard pressed extruded Aluminium 6061-T6 硬挤压铝合金 6061-T6 (13HW)
Cover material 屋面材料	Waterproof, fireproof(DIN4012 B1, M2), UVresistant650-850g/m ² 防腐、防霉、抗紫外线、阻燃 (M2和B1) 等性能达到国际标准

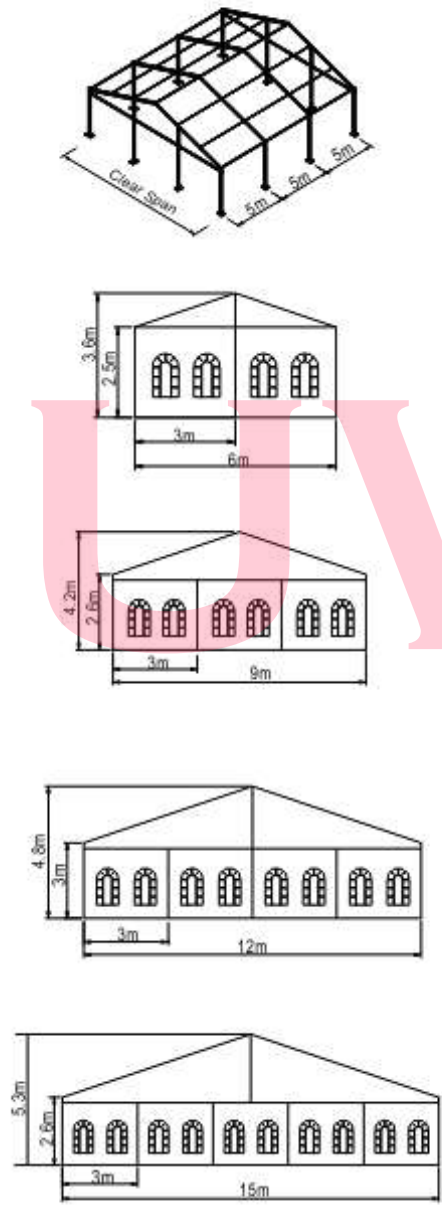

Optional accessories

- PVC window sidewalls PVC侧边围布
- Glass door units 玻璃门
- Anchoring 膨胀螺丝
- Transparent PVC cover and sidewall 透明PVC墙和地壁
- Rain Gutter 雨水槽
- Flooring system 地台
- Lining and curtain 窗帘和围幔
- Weight plate 称重盘
- Hard walling system 硬体墙系统
- Glass walling system 玻璃墙系统

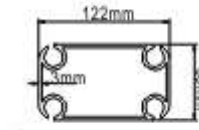

Roof Beam, Upright Support, Gable Pole
顶梁、立柱、端面柱子

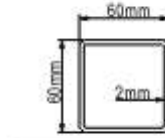

Eave Purlin, Gable pole, Ridge Purlin
Intermediate Purlin
屋檐梁、端面横梁、屋脊梁
屋面方管



Sidewall downside bar
墙底压布杆

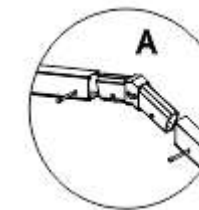
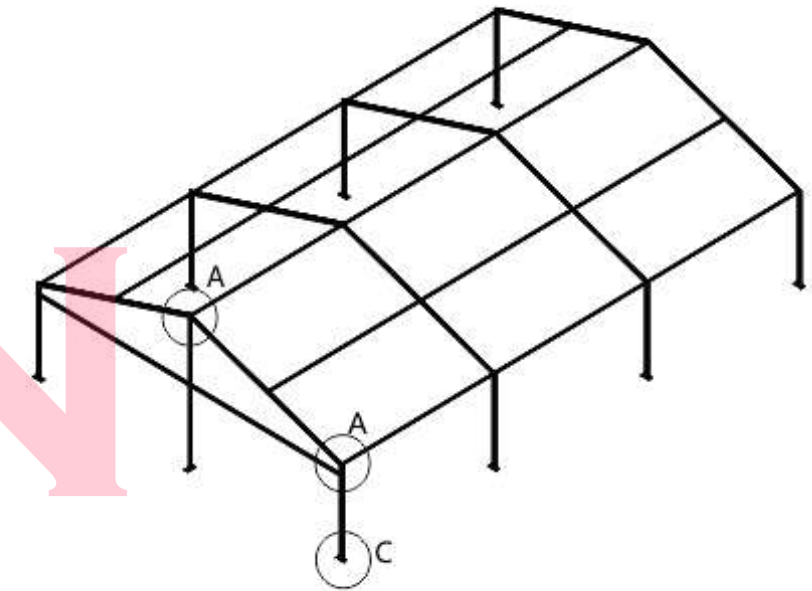

ridge head connection(gable end)
顶角链接

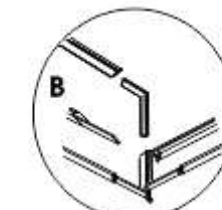

eave corner(field)
屋檐链接

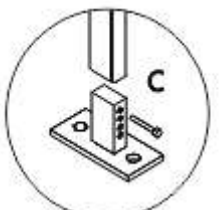

baseplate(field)
底座链接





Item 名称	Specification 规格
Clear-span width 篷房跨度	10m/12m/15m/20m
Eave height 屋檐高度	3m
Ridge height 屋脊高度	4.6m/5.2m/5.4m/6.2m
Roof pitch 屋面坡度	18°
Bay distance 单元间距	5m
Longest component 最长部件	5.5m/6.4m/7.9m/10m
Minimum tent length 最少起订	15m
Roof fixing 屋面固定	No limitide 没有限制
Roof fixing 屋面固定	Rubber tensioning 拉紧器
Main profile 主型材	166x88x3mm(2-channel)
Max. allowed wind speed 最高承受抗风	80km/hour 0.5kn/m ²
Eave/Ridge connection 屋檐/屋脊连接角	Hot-dip Galvanized steel insert 镀锌钢铁
Framework material 框架材料	Hard pressed extruded Aluminium 6061-T6 硬挤压铝合金 6061-T6 (13HW)
Cover material 屋面材料	Waterproof, fireproof(DIN4012 B1, M2), UVresistant 650-850g/m ² 防腐、防霉、抗紫外线、阻燃(M2和B1)等性能达到国际标准

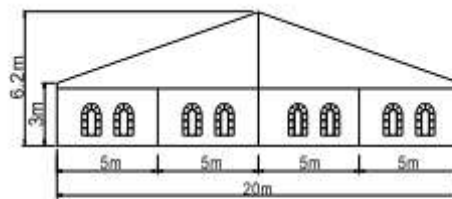
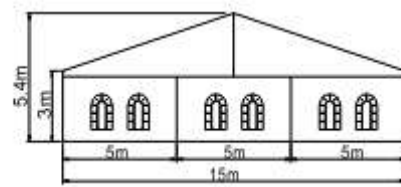
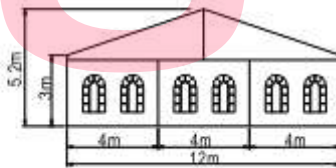
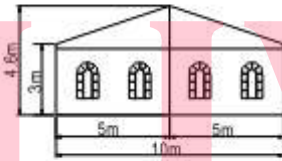
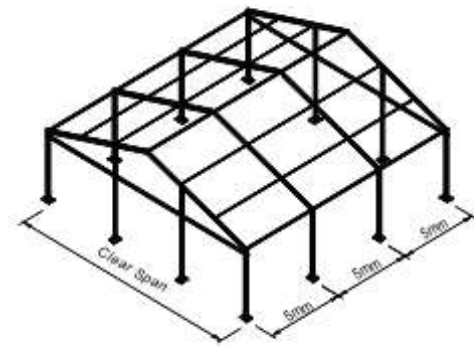

Framework main profile dimension and use
框架主型材尺寸及使用



Roof Beam, Upright Support, Gable pole
顶梁、立柱、端面柱子

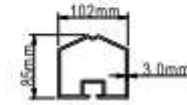

Eave Purlin, Gable pole, Ridge Purlin
屋檐梁、端面柱子、屋脊梁

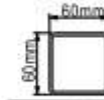

Intermediate Purlin
屋面方管

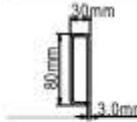

Eave tension rail
屋檐方管、屋面方管、屋脊方管

Optional accessories

- PVC window sidewalls PVC侧边围布
- Glass door units 玻璃门
- Anchoring 膨胀螺丝
- Transparent PVC cover and sidewall 透明PVC墙和墙壁
- Rain Gutter 雨水槽
- Flooring system 地台
- Lining and curtain 窗帘和围幔
- Weight plate 称重盘
- Hard walling system 硬体墙系统
- Glass walling system 玻璃墙系统

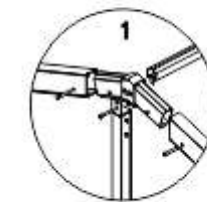

ridge head connection
屋脊链接

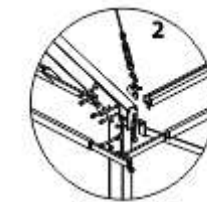

eave corner
屋檐连接角

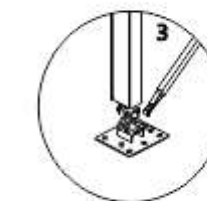

baseplate at the bracing connection
立柱、底座、斜支撑链接

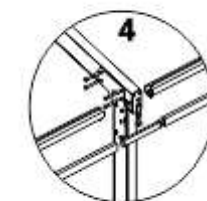

eave corner
屋檐连接角

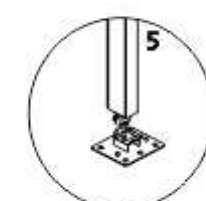

baseplate (field)
底座

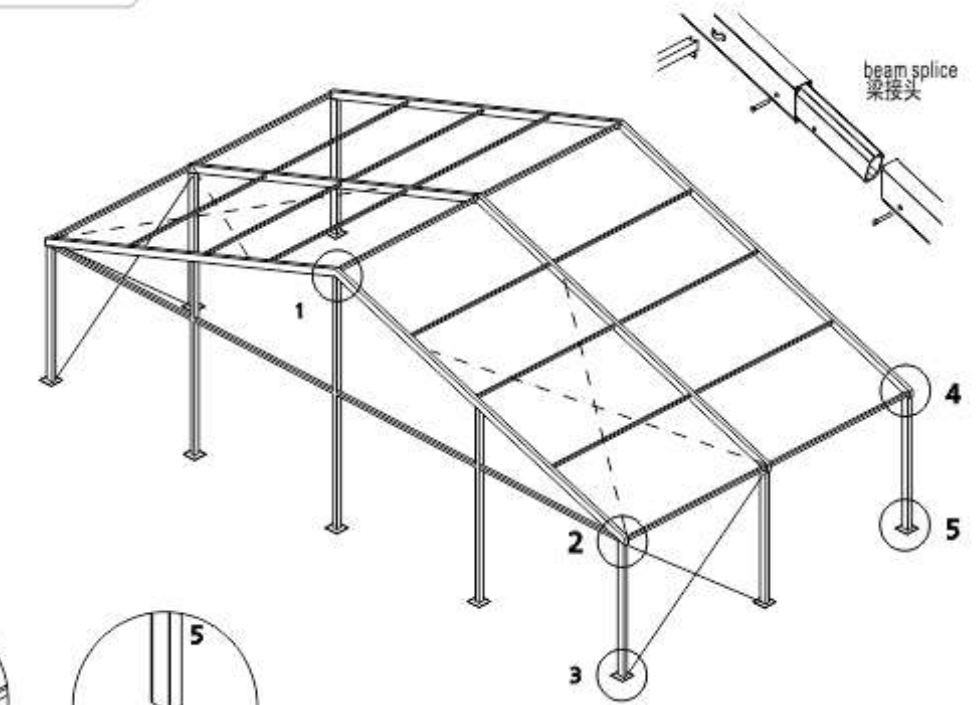

beam splice
梁接头



Item 名称	Specification 规格
Clear-span width 篷房跨度	10m/12m/15m
Eave height 屋檐高度	4m
Ridge height 屋脊高度	5.6m/6.1m/6.4m
Roof pitch 屋面坡度	18°
Bay distance 单元间距	5m
Longest component 最长部件	5.7m/6.3m/7.8m
Minimum tent length 最少起订	15m
Roof fixing 屋面固定	No limit 没有限制
Roof fixing 屋面固定	Rubber tensioning 拉紧器
Main profile 主型材	203x110x4.5mm(2-channel)
Max. allowed wind speed 最高承受抗风	100km/hour 0.5kn/m ²
Eave/Ridge connection 屋檐/屋脊连接角	Hot-dip Galvanized steel insert 镀锌钢铁
Framework material 框架材料	Hard pressed extruded Aluminium 6061-T6 硬挤压铝合金 6061-T6 (13HW)
Cover material 屋面材料	Waterproof, fireproof (DIN4012 B1, M2), UV resistant 700-900g/m ² 防腐、防霉、抗紫外线、阻燃 (M2和B1) 等性能达到国际标准

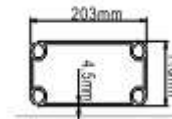
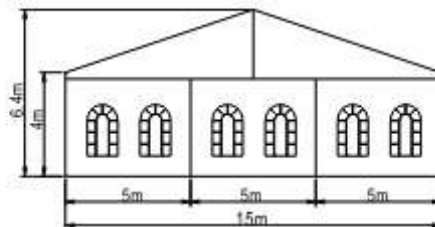
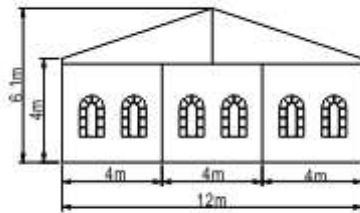
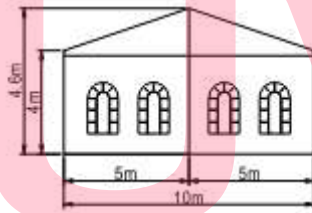
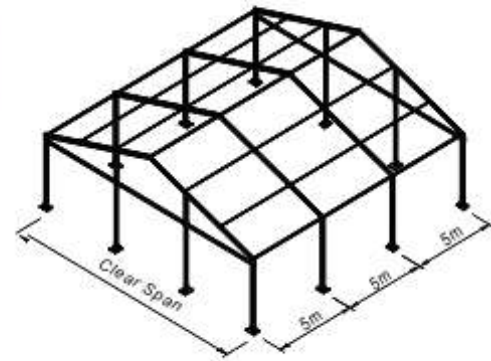

Roof Beam, Upright Support,
顶梁、立柱、

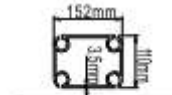

Gable pole
端面柱子

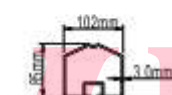

Eave Purlin, Gable pole, Ridge Purlin
屋檐梁、端面柱子、屋脊梁



Intermediate Purlin
屋面方管



Eave tension rail
屋檐方管、屋面方管、屋脊方管

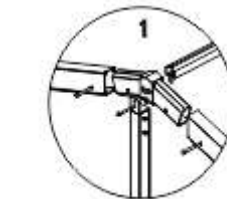

ridge head connection
屋脊链接

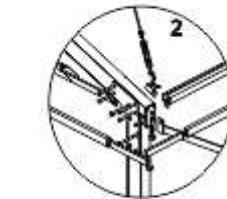

eave corner
屋檐连接角

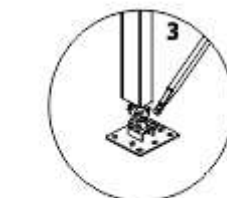

baseplate at the bracing connection
立柱、底座、斜支撑链接

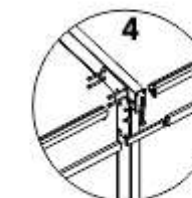

eave corner
屋檐连接角

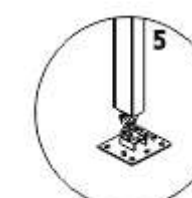

baseplate (field)
底座

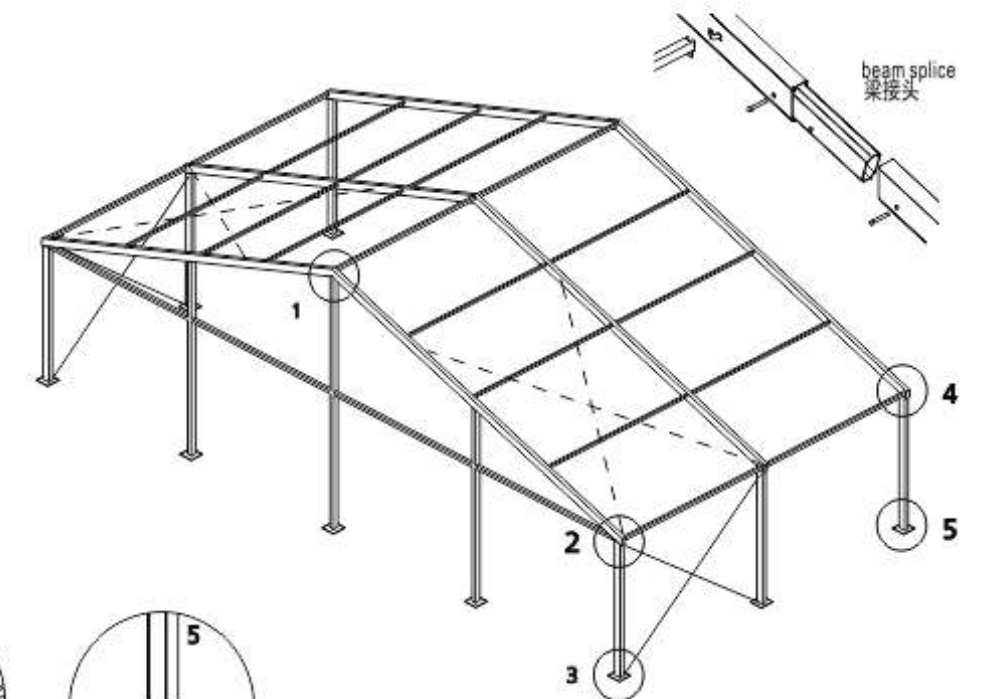

Optional accessories

- PVC window sidewalls PVC侧边围布
- Glass door units 玻璃门
- Anchoring 膨胀螺丝
- Transparent PVC cover and sidewall 透明PVC墙和墙壁
- Rain Gutter 雨水槽
- Flooring system 地台
- Lining and curtain 窗帘和围幔
- Weight plate 称重盘
- Hard walling system 硬体墙系统
- Glass walling system 玻璃墙系统



Item 名称	Specification 规格
Clear-span width 篷房跨度	20m/21m/25m/30m
Eave height 屋檐高度	4m
Ridge height 屋脊高度	7.2m/7.4m/8m/8.8m
Roof pitch 屋面坡度	18°
Bay distance 单元间距	5m
Longest component 最长部件	10.5m
Minimum tent length 最少起订	15m
Roof fixing 屋面固定	No limit 没有限制
Roof fixing 屋面固定	Rubber tensioning 拉紧器
Main profile 主型材	254x120x5mm(2-channel)
Max. allowed wind speed 最高承受抗风	100km/hour 0.5kn/m ²
Eave/Ridge connection 屋檐/屋脊连接角	Hot-dip Galvanized steel insert 镀锌钢铁
Framework material 框架材料	Hard pressed extruded Aluminium 6061-T6 硬挤压铝合金 6061-T6 (13HW)
Cover material 屋面材料	Waterproof, fireproof(DIN4012 B1, M2), UVresistant 700-900g/m ² 防腐、防霉、抗紫外线、阻燃(M2和B1)等性能达到国际标准

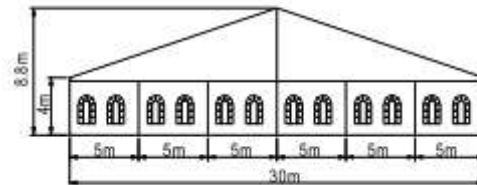
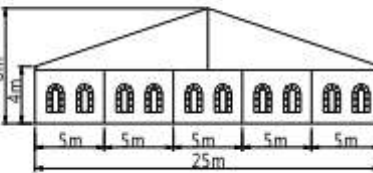
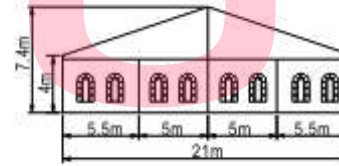
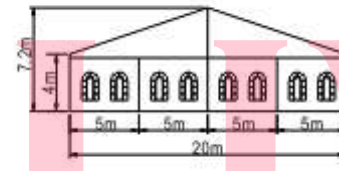
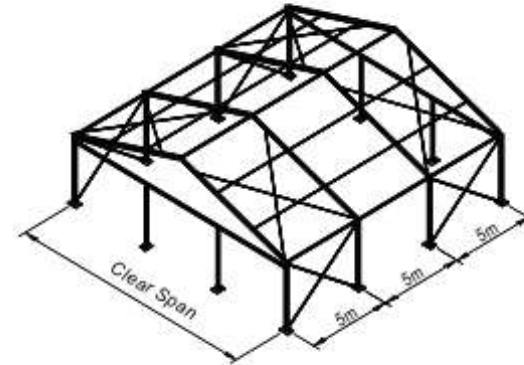

Framework main profile dimension and use
框架主型材尺寸及使用

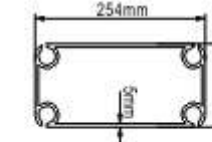
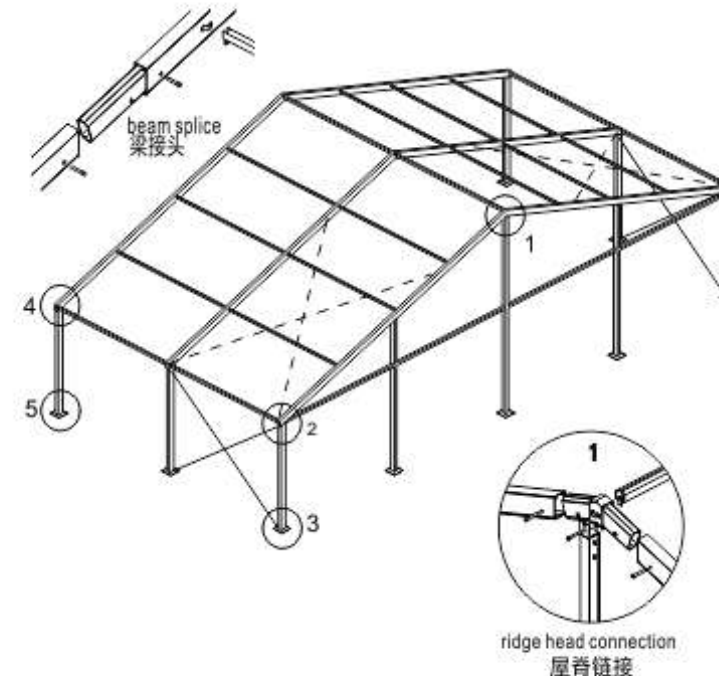

Roof Beam, Upright Support,
顶梁、立柱、

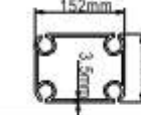

Gable pole
端面柱子

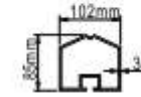

Eave Purlin, Gable pole, Ridge Purlin
屋檐梁、端面柱子、屋脊梁

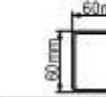

Intermediate Purlin
屋面方管



Eave tension rail
屋檐方管、屋面方管、屋脊方管

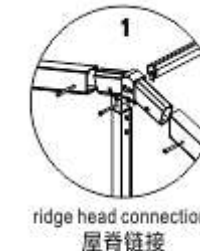

ridge head connection
屋脊链接

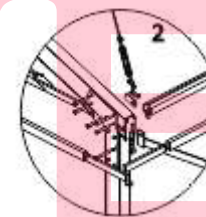

eave corner
屋檐连接角

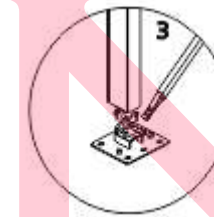

baseplate at the bracing connection
立柱、底座、斜支撑链接

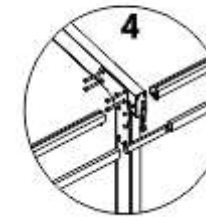

eave corner
屋檐连接角

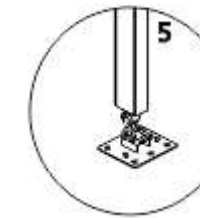

baseplate (field)
底座

Optional accessories

- | | |
|------------------------------------|-----------|
| PVC window sidewalls | PVC侧边围布 |
| Glass door units | 玻璃门 |
| Anchoring | 膨胀螺丝 |
| Transparent PVC cover and sidewall | 透明PVC墙和墙壁 |
| Rain Gutter | 雨水槽 |
| Flooring system | 地台 |
| Lining and curtain | 窗帘和围幔 |
| Weight plate | 称重盘 |
| Hard walling system | 硬体墙系统 |
| Glass walling system | 玻璃墙系统 |





Item 名称	Specification 规格
Clear-span width 篷房跨度	30m/40m/50m
Eave height 屋檐高度	4m
Ridge height 屋脊高度	8.8m/10.3m/12.0m
Roof pitch 屋面坡度	18°
Bay distance 单元间距	5m
Longest component 最长部件	10.5m
Minimum tent length 最少起订	30m
Roof fixing 屋面固定	No limit 没有限制
Roof fixing 屋面固定	Rubber tensioning 拉紧器
Main profile 主型材	300x125x6mm(2-channel)
Max. allowed wind speed 最高承受抗风	100km/hour 0.5kn/m ²
Eave/Ridge connection 屋檐/屋脊连接角	Hot-dip Galvanized steel insert 镀锌钢铁
Framework material 框架材料	Hard pressed extruded Aluminium 6061-T6 硬挤压铝合金 6061-T6 (13HW)
Cover material 屋面材料	Waterproof, fireproof(DIN4012 B1, M2), UVresistant 700-900g/m ² 防腐、防霉、抗紫外线、阻燃 (M2和B1) 等性能达到国际标准

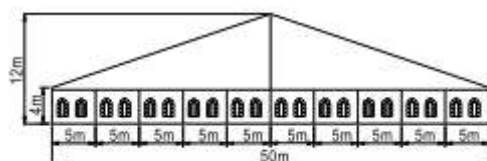
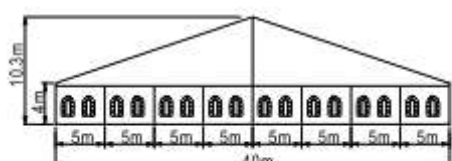
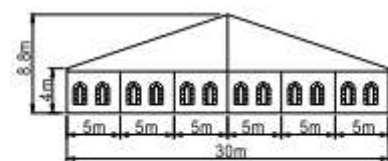
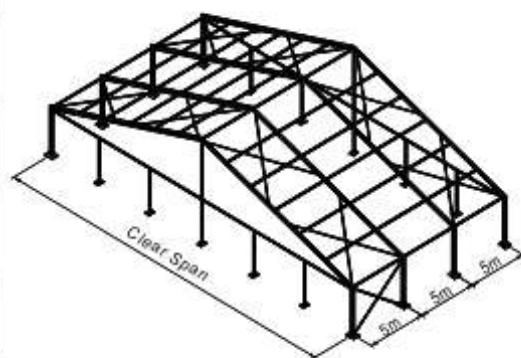

Framework main profile dimension and use
框架主型材尺寸及使用

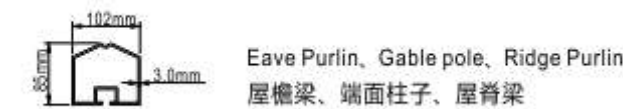
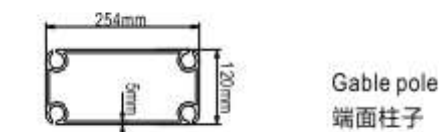
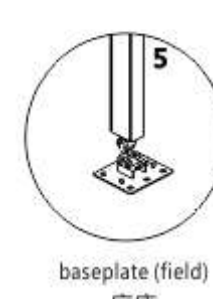
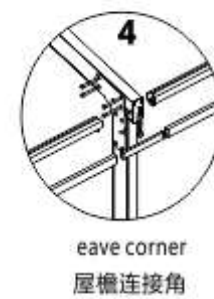
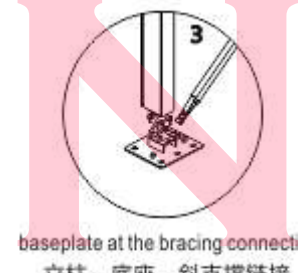
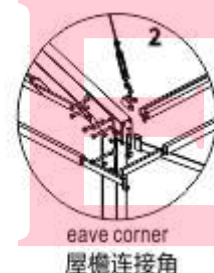
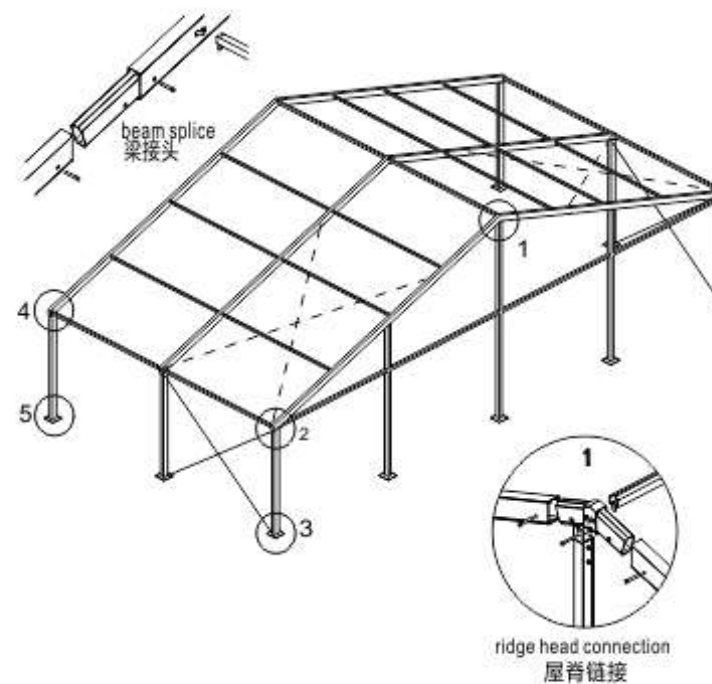

Optional accessories

- | | |
|------------------------------------|-----------|
| PVC window sidewalls | PVC侧边围布 |
| Glass door units | 玻璃门 |
| Anchoring | 膨胀螺丝 |
| Transparent PVC cover and sidewall | 透明PVC墙和墙壁 |
| Rain Gutter | 雨水槽 |
| Flooring system | 地台 |
| Lining and curtain | 窗帘和围幔 |
| Weight plate | 称重盘 |
| Hard walling system | 硬体墙系统 |
| Glass walling system | 玻璃墙系统 |



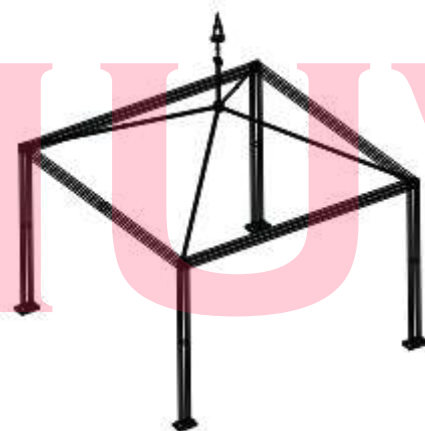
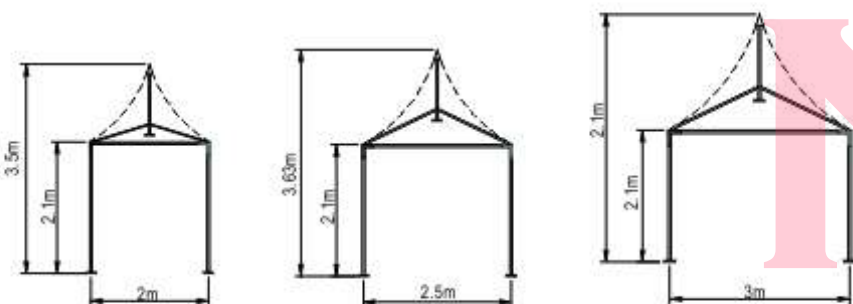

Item 名称	Specification 规格
Clear-span width 篷房跨度	30m/40m/50m
Eave height 屋檐高度	2.5m
Ridge height 屋脊高度	3.75m/4.03m/4.3mm
Wind loading 抗风	80km/hour 0.3kn/m ²
Main profile 主型材	88x58x3mm(2-channel)
Eave connection 屋檐连接角	Hot-dip Galvanized steel insert 镀锌钢铁
Framework material 框架材料	Hard pressed extruded Aluminium 6061-T6 硬挤压铝合金 6061-T6 (13HW)
Cover material 篷面材料	Waterproof, fireproof(DIN4012 B1,M2), UVresistant 防腐、防霉、抗紫外线、阻燃 (M2和B1) 等性能达到国际标准

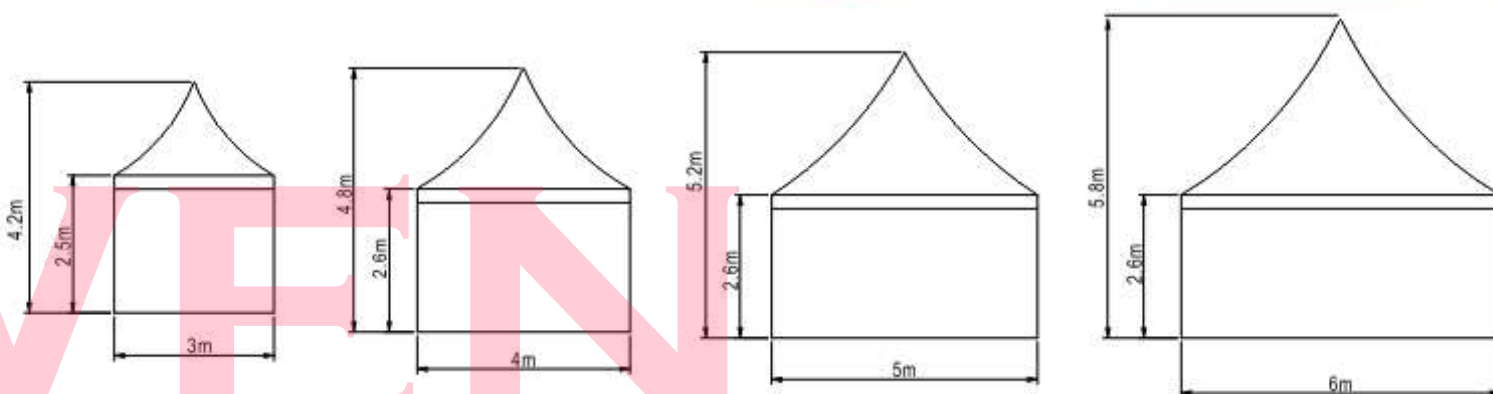
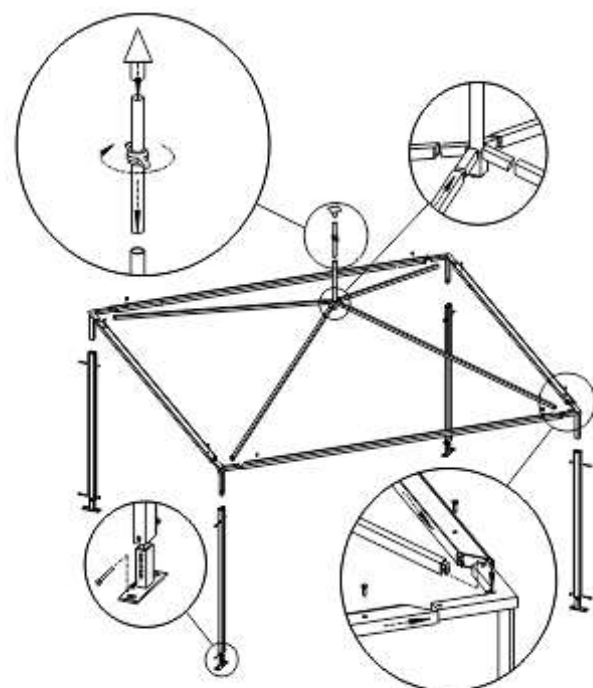

Item 名称	Specification 规格
Clear-span width 篷房跨度	3m/4m/5m/6m
Eave height 屋檐高度	2.5m
Ridge height 屋脊高度	4.2m/4.8m/5.2m/5.8m
Wind loading 抗风	80km/hour 0.3kn/m ²
Main profile 主型材	88x58x3mm(2-channel)
Eave connection 屋檐连接角	Hot-dip Galvanized steel insert 镀锌钢铁
Framework material 框架材料	Hard pressed extruded Aluminium 6061-T6 硬挤压铝合金 6061-T6 (13HW)
Cover material 篷面材料	Waterproof, fireproof(DIN4012 B1,M2), UVresistant 防腐、防霉、抗紫外线、阻燃 (M2和B1) 等性能达到国际标准





Item 名称	Specification 规格
Clear-span width 篷房跨度	6m/8m/10m
Eave height 屋檐高度	2.5m/2.6m
Ridge height 屋脊高度	5.8m/6.4m/6.9m
Wind loading 抗风	80km/hour 0.3kn/m ²
Main profile 主型材	120x68x3mm(2-channel)
Eave connection 屋檐连接角	Hot-dip Galvanized steel insert 镀锌钢铁
Framework material 框架材料	Hard pressed extruded Aluminium 6061-T6 硬挤压铝合金 6061-T6 (13HW)
Cover material 屋面材料	Waterproof, fireproof(DIN4012 B1, M2), UVresistant 防腐、防霉、抗紫外线、阻燃 (M2和B1) 等性能达到国际标准



Optional accessories

- PVC window sidewalls PVC侧边围布
- Glass door units 玻璃门
- Anchoring 膨胀螺丝
- Transparent PVC cover and sidewall 透明PVC墙和墙壁
- Rain Gutter 雨水槽
- Flooring system 地台
- Lining and curtain 窗帘和围幔
- Weight plate 称重盘

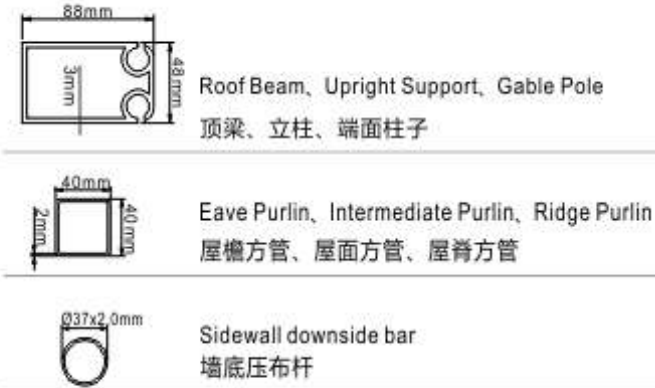
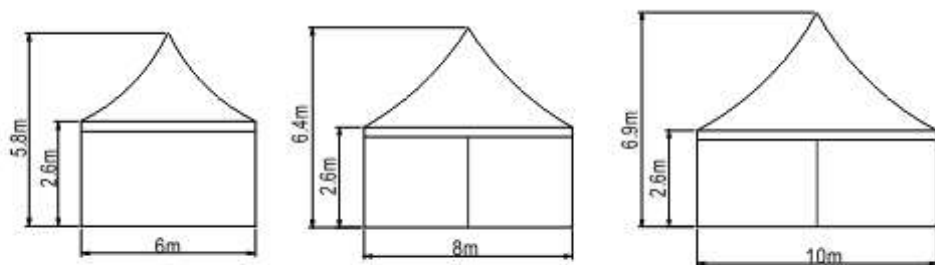
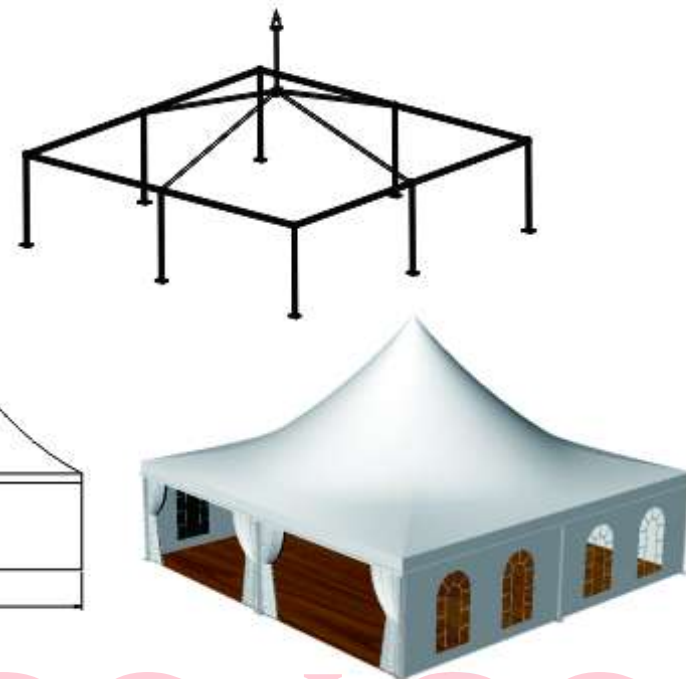

Item 名称	Specification 规格
Clear-span width 篷房跨度	6m/8m
Eave height 屋檐高度	2.6m
Ridge height 屋脊高度	3.75m/4.05m
Wind loading 抗风	80km/hour 0.3kn/m ²
Main profile 主型材	88X58X3mm(2-channel)
Eave connection 屋檐连接角	Hot-dip Galvanized steel insert 镀锌钢铁
Framework material 框架材料	Hard pressed extruded Aluminium 6061-T6 硬挤压铝合金 6061-T6 (13HW)
Cover material 屋面材料	Waterproof, fireproof(DIN4012 B1, M2), UVresistant 防腐、防霉、抗紫外线、阻燃 (M2和B1) 等性能达到国际标准

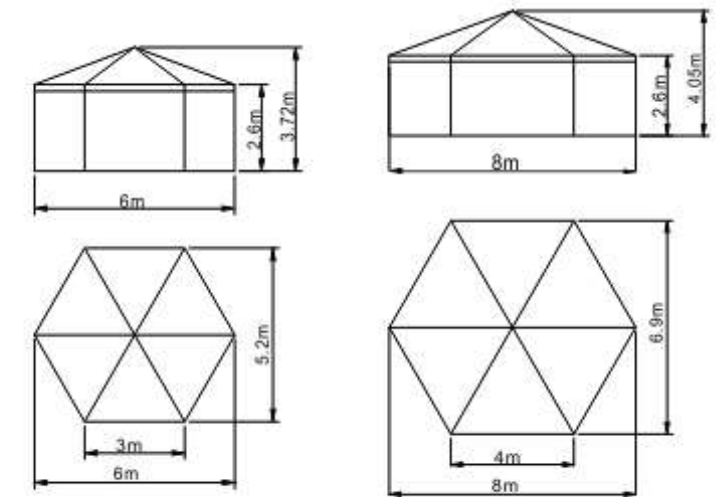
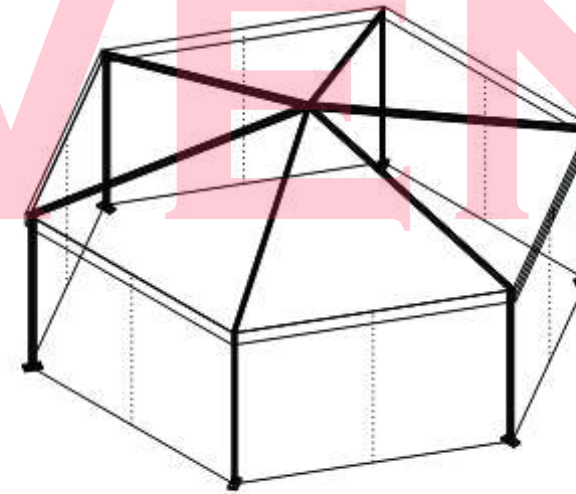

Optional accessories

- PVC window sidewalls PVC侧边围布
- Glass door units 玻璃门
- Anchoring 膨胀螺丝
- Transparent PVC cover and sidewall 透明PVC墙和墙壁
- Rain Gutter 雨水槽
- Flooring system 地台
- Lining and curtain 窗帘和围幔
- Weight plate 称重盘





Item 名称	Specification 规格
Clear-span width 篷房跨度	10m/12m
Eave height 屋檐高度	2.6m
Ridge height 屋脊高度	4.4m/4.8m
Wind loading 抗风	80km/hour 0.3kn/m ²
Main profile 主型材	400x125x7mm(2-channel)
Eave connection 屋檐连接角	Hot-dip Galvanized steel insert 镀锌钢铁
Framework material 框架材料	Hard pressed extruded Aluminium 6061-T6 硬挤压铝合金 6061-T6 (13HW)
Cover material 屋面材料	Waterproof, fireproof(DIN4012 B1, M2), UVresistant 防腐、防霉、抗紫外线、阻燃(M2和B1)等性能达到国际标准

Optional accessories

PVC window sidewalls	PVC侧边围布
Glass door units	玻璃门
Anchoring	膨胀螺丝
Transparent PVC cover and sidewall	透明PVC墙和墙壁
Rain Gutter	雨水槽
Flooring system	地台
Lining and curtain	帘子和围幔
Weight plate	称重盘
Hard walling system	硬体墙系统
Glass walling system	玻璃墙系统

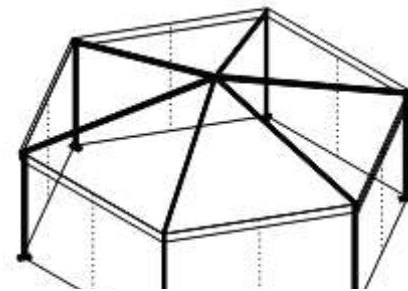
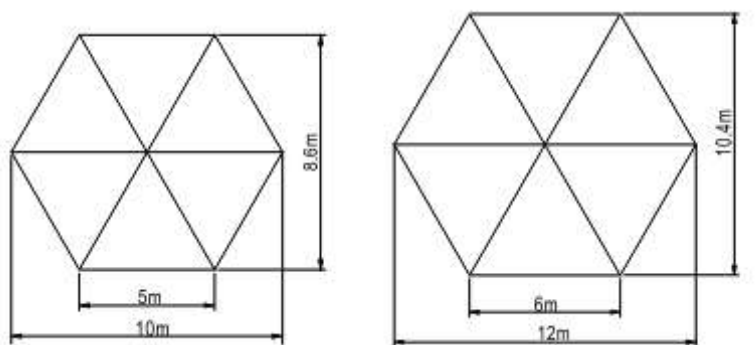
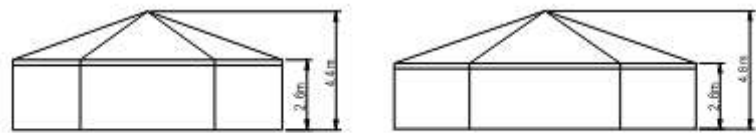
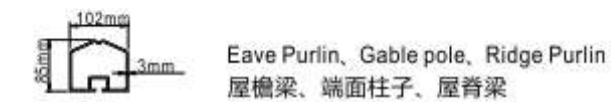
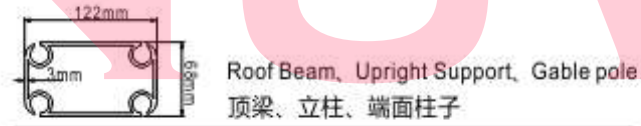

Item 名称	Specification 规格
Clear-span width 篷房跨度	6m/8m/9m
Eave height 屋檐高度	2.6m
Ridge height 屋脊高度	5.2m/5.7m/5.83m
Wind loading 抗风	80km/hour 0.3kn/m ²
Main profile 主型材	400x125x7mm(2-channel)
Eave connection 屋檐连接角	Hot-dip Galvanized steel insert 镀锌钢铁
Framework material 框架材料	Hard pressed extruded Aluminium 6061-T6 硬挤压铝合金 6061-T6 (13HW)
Cover material 屋面材料	Waterproof, fireproof(DIN4012 B1, M2), UVresistant 防腐、防霉、抗紫外线、阻燃(M2和B1)等性能达到国际标准

Optional accessories

PVC window sidewalls	PVC侧边围布
Glass door units	玻璃门
Anchoring	膨胀螺丝
Transparent PVC cover and sidewall	透明PVC墙和墙壁
Rain Gutter	雨水槽
Flooring system	地台
Lining and curtain	帘子和围幔
Weight plate	称重盘

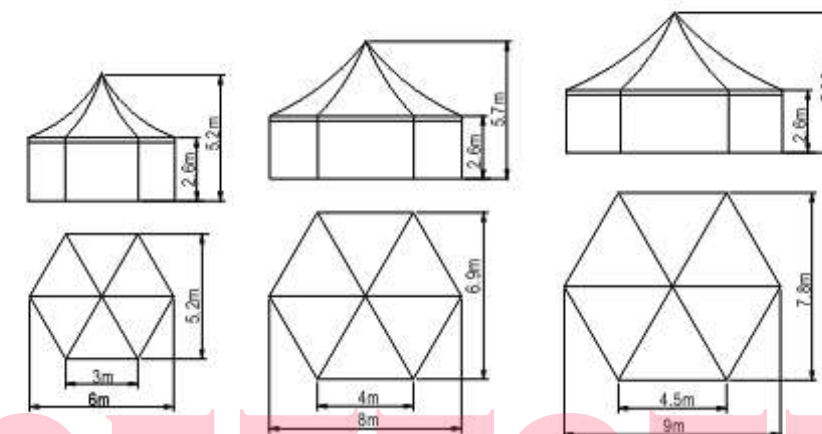
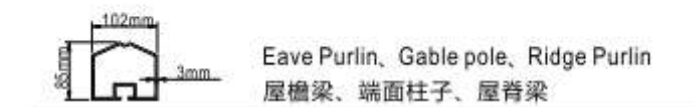



Optional accessories	
PVC window sidewalls	PVC侧边围布
Glass door units	玻璃门
Anchoring	膨胀螺丝
Transparent PVC cover and sidewall	透明PVC墙和墙壁
Rain Gutter	雨水槽
Flooring system	地台
Lining and curtain	窗帘和围幔
Weight plate	称重盘
Hard walling system	硬体墙系统
Glass walling system	玻璃墙系统



Item 名称	Specification 规格
Clear-span width 篷房跨度	16m/18m/30m/35m
Eave height 屋檐高度	4m
Top height 屋脊高度	6.6m/6.8m/8.8m/9m
Minimum tent length 最少起订	No limit 没有限制
Roof fixing 屋面固定	Rubber tensioning 拉紧器
Main profile(1) 主型材(1)	203x110x4.5mm(2-channel)
Main profile(2) 主型材(2)	166x88x3mm(2-channel)
Max. allowed wind speed 最高承受抗风	100km/hour 0.5kn/m ²
Eave/Ridge connection 屋檐/屋脊连接角	Hot-dip Galvanized steel insert 镀锌钢铁
Framework material 框架材料	Hard pressed extruded Aluminium 6061-T6 硬挤压铝合金 6061-T6 (13HW)
Cover material 屋面材料	Waterproof, fireproof(DIN4012 B1, M2), UVresistant 700-900g/m ² 防腐、防霉、抗紫外线、阻燃(M2和B1)等性能达到国际标准

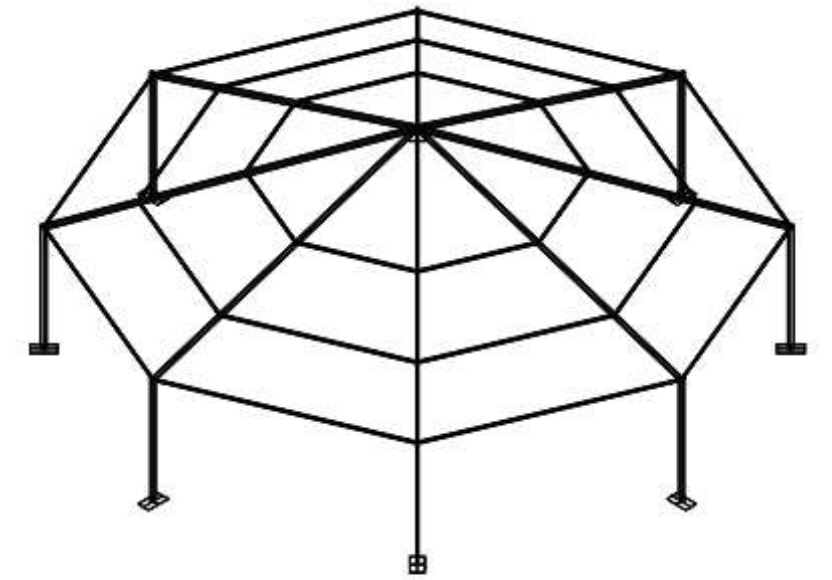
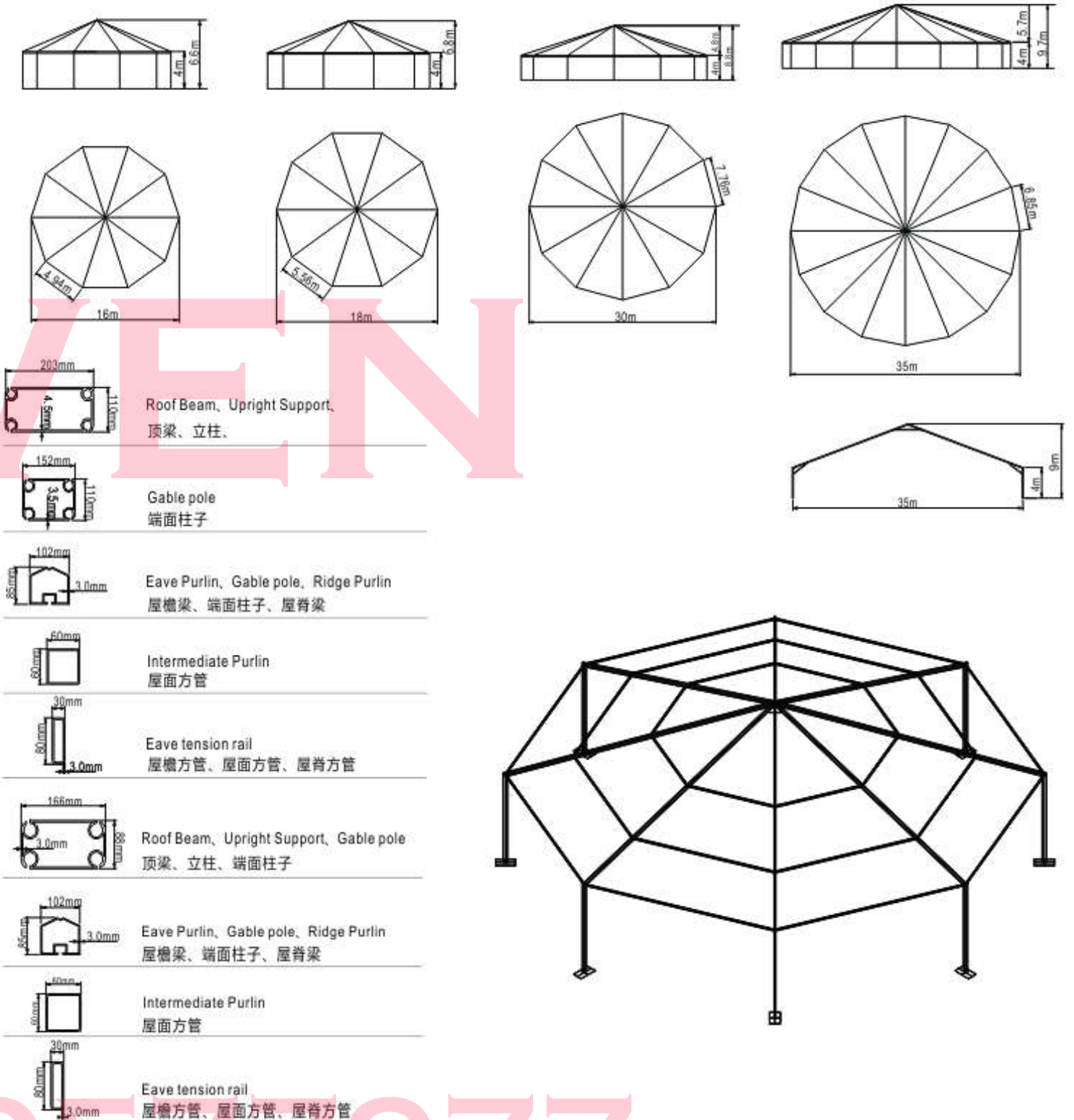

Polygon tent Technical Data 多边形篷房技术参数

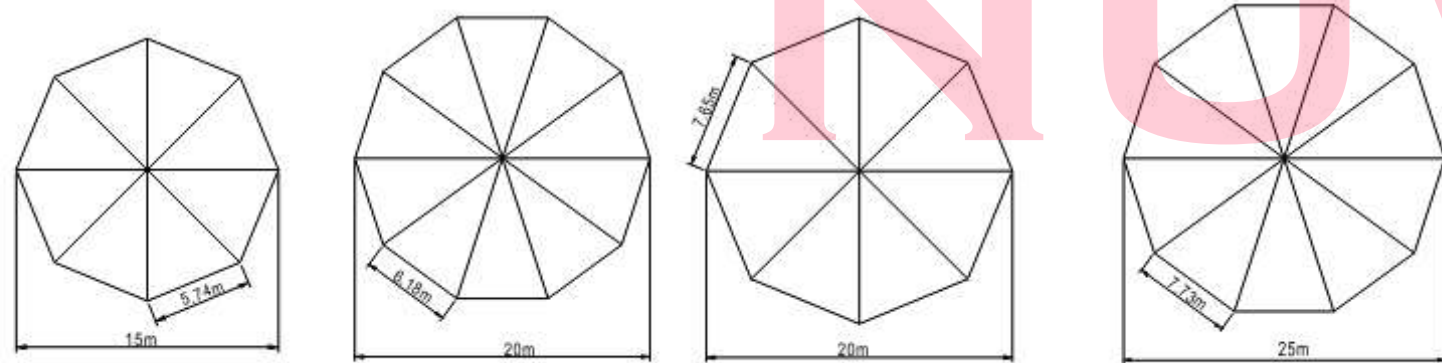
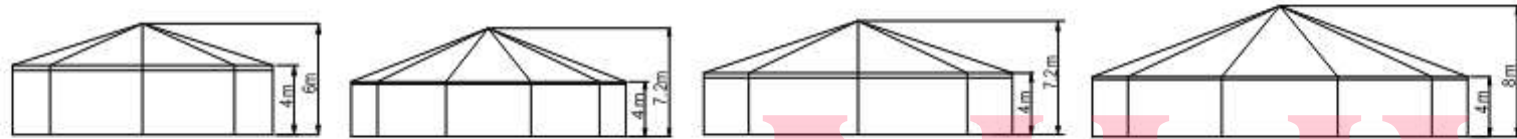

Max. allowed wind speed 最高承受抗风	80km/hour 0.3kn/m ²
Eave/Ridge connection 屋檐/屋脊连接角	Hot-dip Galvanized steel insert 镀锌钢铁
Framework material 框架材料	Hard pressed extruded Aluminium 6061-T6 硬挤压铝合金 6061-T6 (13HW)
Cover material 屋面材料	Waterproof, fireproof (DIN4012 B1, M2), UV resistant 防腐、防霉、抗紫外线、阻燃 (M2和B1) 等性能达到国际标准



Dome Mini tent Technical Data 迷你圆形篷房技术参数

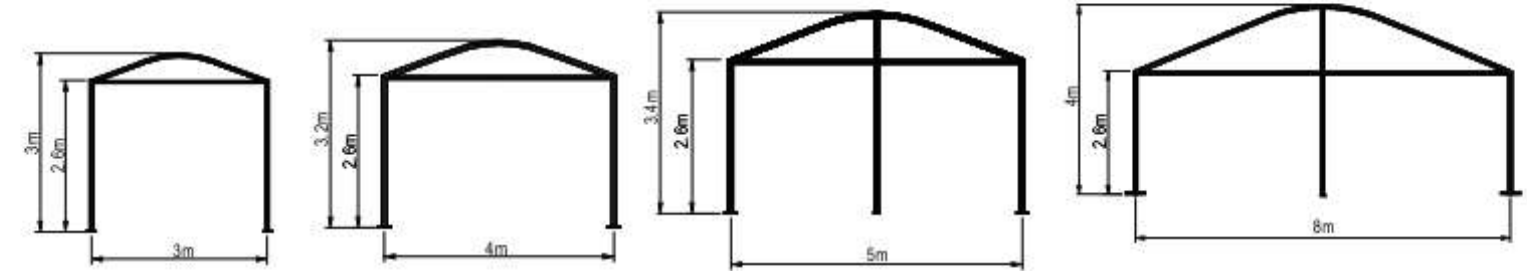

Item 名称	Specification 规格
Clear-span width 篷房跨度	3m/4m/5m/8m
Eave height 屋檐高度	2.6m
Ridge height 屋脊高度	3m/3.2m/3.4m/4m
Roof pitch 屋面坡度	18°
Bay distance 单元间距	3m
Longest component 最长部件	3.5m/4.1m/5m/4.25m
Minimum tent length 最少起订	6m
Roof fixing 屋面固定	Rubber tensioning 拉紧器
Main profile 主型材	82x48x3mm (2-channel)
Max. allowed wind speed 最高承受抗风	80km/hour 0.3kn/m ²
Eave/Ridge connection 屋檐/屋脊连接角	Hot-dip Galvanized steel insert 镀锌钢铁
Framework material 框架材料	Hard pressed extruded Aluminium 6061-T6 硬挤压铝合金 6061-T6 (13HW)
Cover material 屋面材料	Waterproof, fireproof (DIN4012 B1, M2), UV resistant 防腐、防霉、抗紫外线、阻燃 (M2和B1) 等性能达到国际标准

Optional accessories	
PVC window sidewalls	PVC侧边围布
Glass door units	玻璃门
Anchoring	膨胀螺丝
Transparent PVC cover and sidewall	透明PVC墙和墙壁
Rain Gutter	雨水槽
Flooring system	地台
Lining and curtain	窗帘和围幔
Weight plate	称重盘

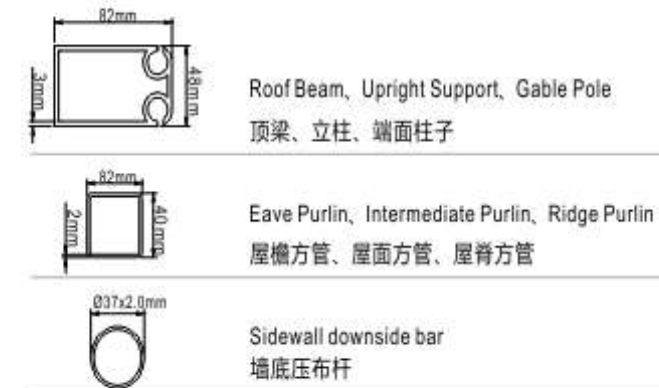



Item 名称	Specification 规格
Clear-span width 篷房跨度	15m/20m/25m/30m
Eave height 屋檐高度	4m
Ridge height 屋脊高度	8m/9.2m/10.3m/11.5m
Roof pitch 屋面坡度	18°
Bay distance 单元间距	5m
Longest component 最长部件	6.7m/7.7m/11m/14.8m
Minimum tent length 最少起订	30m
Roof fixing 屋面固定	No limit 没有限制
Roof fixing 屋面固定	Rubber tensioning 拉紧器
Main profile 主型材	300x125x6mm(2-channel)
Max. allowed wind speed 最高承受抗风	100km/hour 0.5kn/m ²
Eave/Ridge connection 屋檐/屋脊连接角	Hot-dip Galvanized steel insert 镀锌钢铁
Framework material 框架材料	Hard pressed extruded Aluminium 6061-T6 硬挤压铝合金 6061-T6 (13HW)
Cover material 屋面材料	Waterproof, fireproof (DIN4012 B1, M2), UV resistant 700- 防腐、防霉、抗紫外线、阻燃 (M2和B1) 等性能达到国际标准

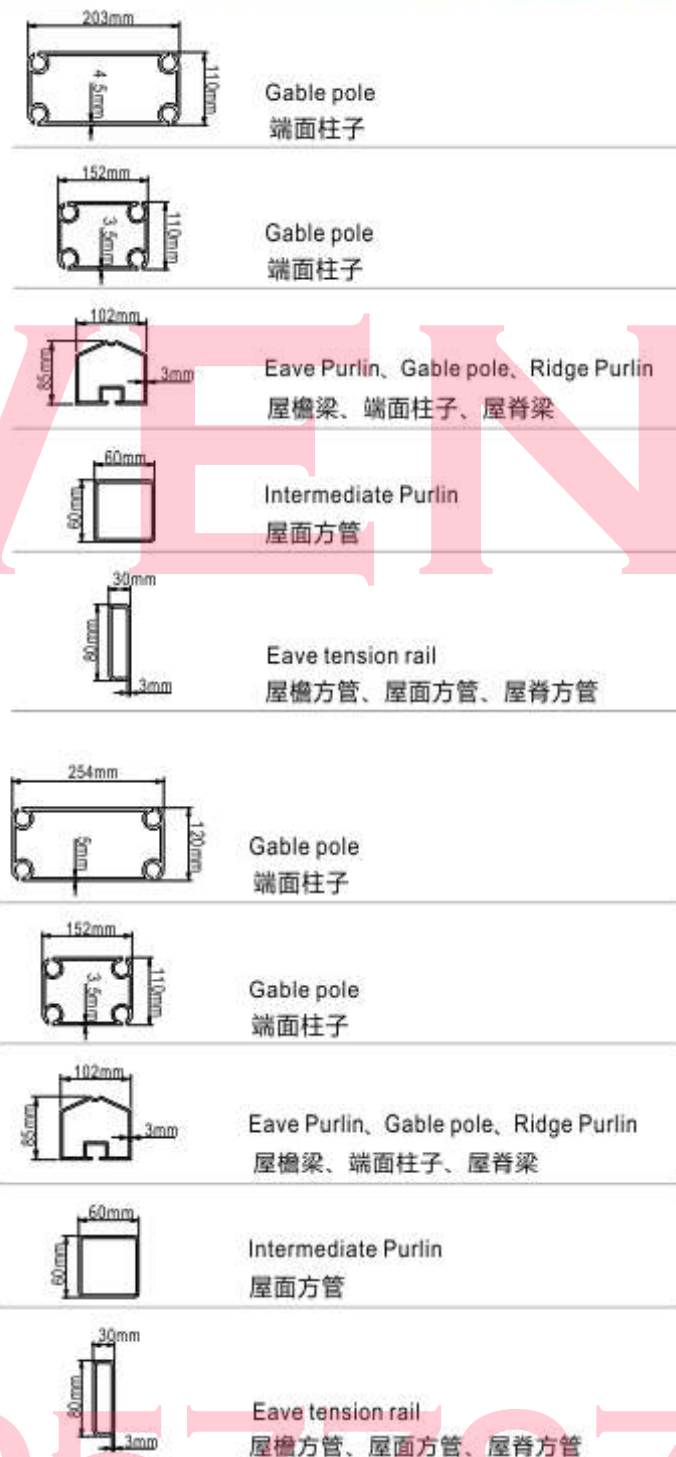
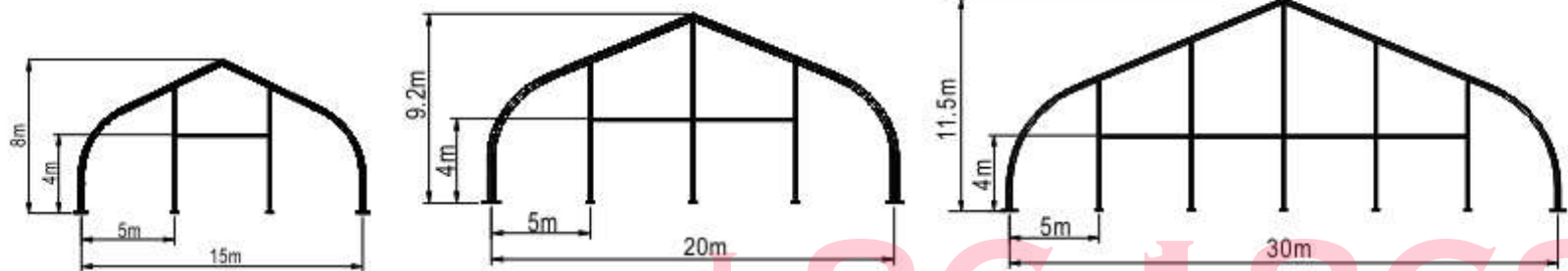
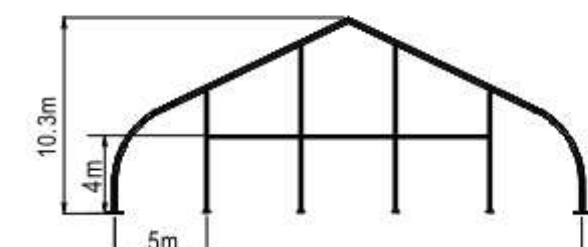
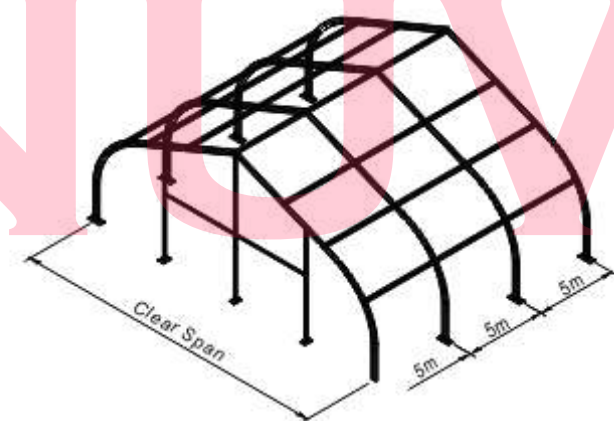
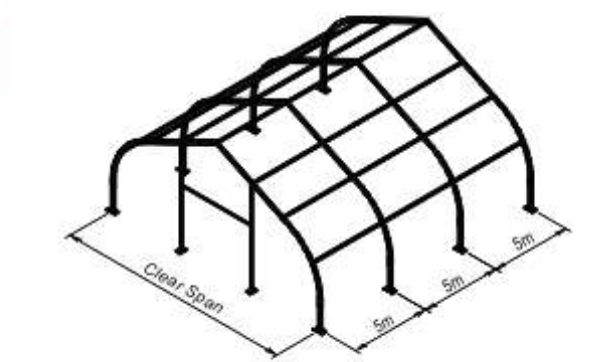

Optional accessories	
PVC window sidewalls	PVC侧边围布
Glass door units	玻璃门
Anchoring	膨胀螺丝
Transparent PVC cover and sidewall	透明PVC墙和墙壁
Rain Gutter	雨水槽
Flooring system	地台
Lining and curtain	窗帘和围幔
Weight plate	称重盘





Optional accessories

- PVC window sidewalls PVC侧边围布
- Glass door units 玻璃门
- Anchoring 膨胀螺丝
- Transparent PVC cover and sidewall 透明PVC墙和墙壁
- Rain Gutter 雨水槽
- Flooring system 地台
- Lining and curtain 窗帘和围幔
- Weight plate 称重盘
- Hard walling system 硬体墙系统
- Glass walling system 玻璃墙系统

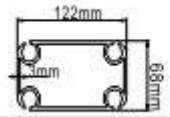

Roof Beam, Upright Support, Gable Pole
顶梁、立柱、端面柱子

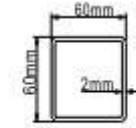

Eave Purlin, Gable pole, Ridge Purlin
Intermediate Purlin
屋檐梁、端面横梁、屋脊梁
屋面方管



Sidewall downside bar
墙底压布杆

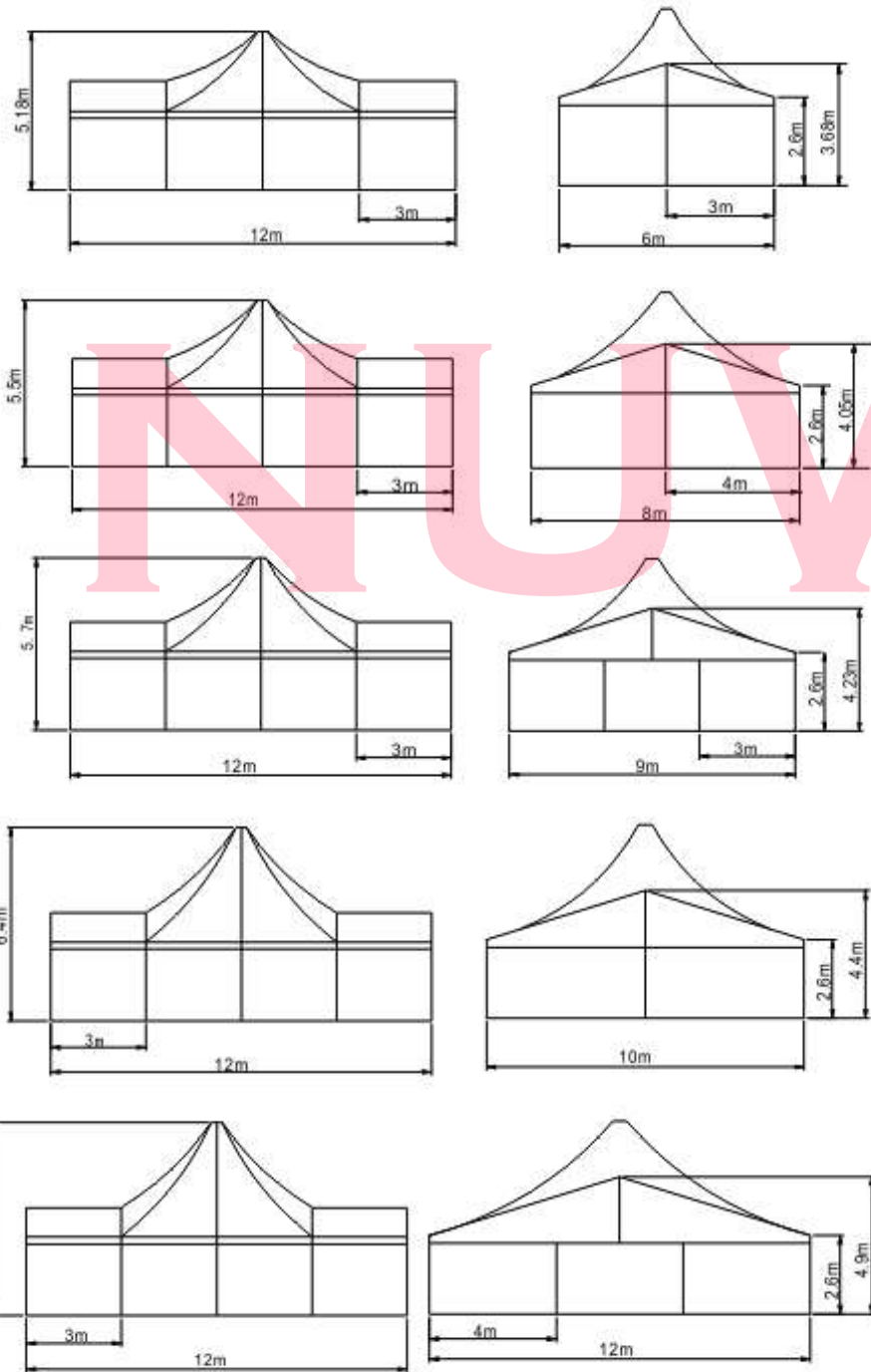

Item 名称	Specification 规格
Max. allowed wind speed 最高承受抗风	80km/hour 0.3kn/m ²
Eave/Ridge connection 屋檐/屋脊连接角	Hot-dip Galvanized steel insert 镀锌钢铁
Framework material 框架材料	Hard pressed extruded Aluminium 6061-T6 硬挤压铝合金 6061-T6 (13HW)
Cover material 屋面材料	Waterproof, fireproof (DIN4012 B1, M2), UV resistant 防腐、防霉、抗紫外线、阻燃 (M2和B1) 等性能达到国际标准

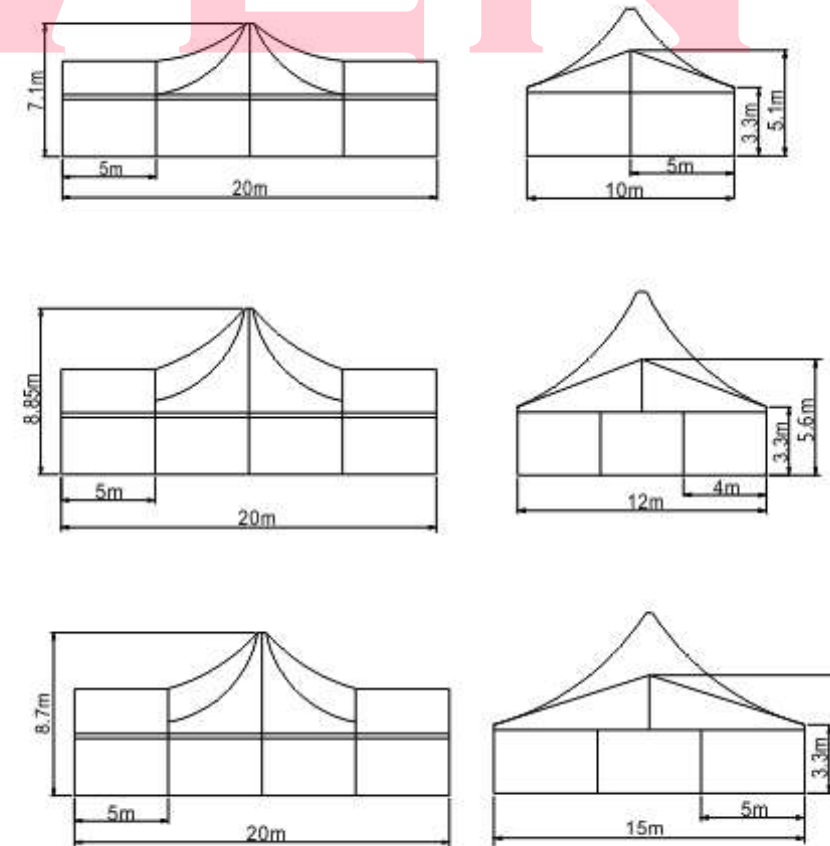

Optional accessories

- PVC window sidewalls PVC侧边围布
- Glass door units 玻璃门
- Anchoring 膨胀螺丝
- Transparent PVC cover and sidewall 透明PVC墙和墙壁
- Rain Gutter 雨水槽
- Flooring system 地台
- Lining and curtain 窗帘和围幔
- Weight plate 称重盘
- Hard walling system 硬体墙系统
- Glass walling system 玻璃墙系统

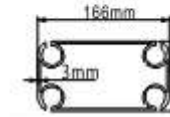

Roof Beam, Upright Support, Gable pole
顶梁、立柱、端面柱子

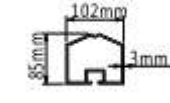

Eave Purlin, Gable pole, Ridge Purlin
屋檐梁、端面柱子、屋脊梁



Intermediate Purlin
屋面方管

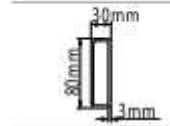

Eave tension rail
屋檐方管、屋面方管、屋脊方管



+86-18680577977





Sanya exhibition tent
三亚展览篷房案例



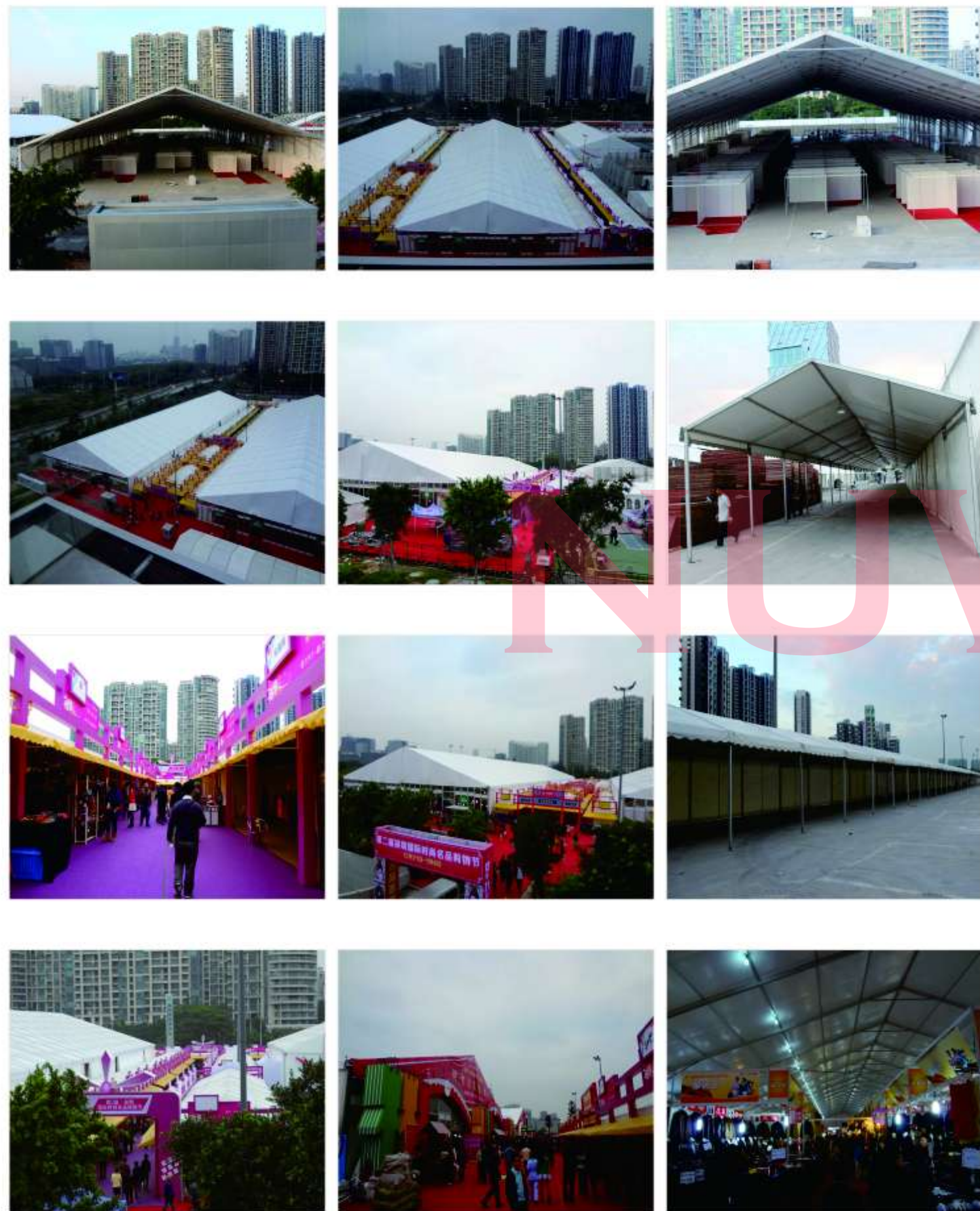

NUWEN

+86-18680577977

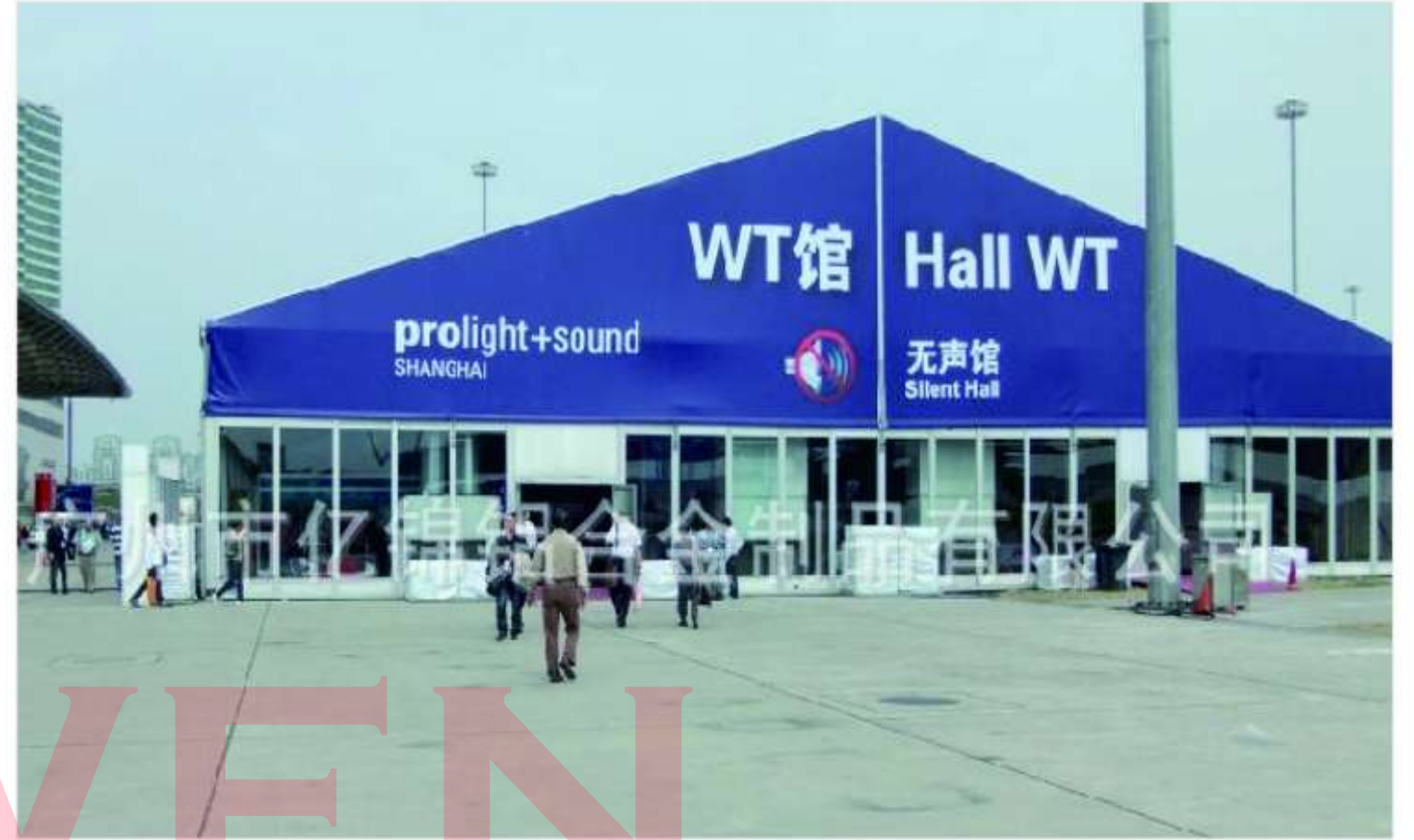
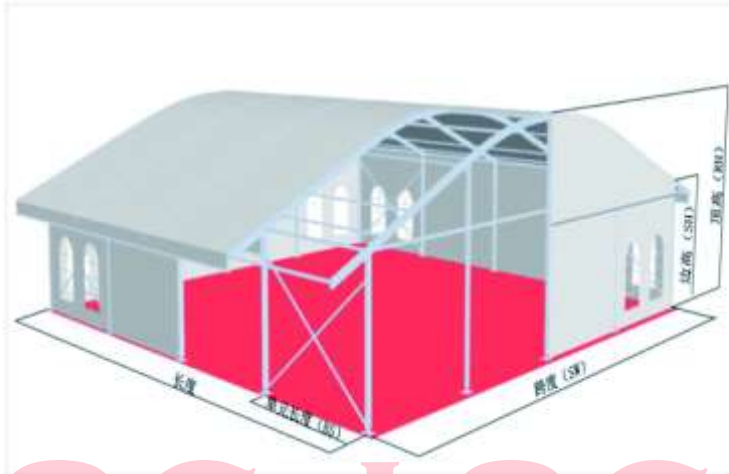

NUWEN





NUWEN

+86-18680577977



ABS Hard wall Cases——篷房ABS墙



+86-18680577977





沙发茶几
Sofa table



仓储框
Storage box



ABS墙
ABS Hard Wall



硬体墙
Hardware Wall



木地板
Wooden Floor



配重套
Counterweight sets



透明窗
Transparent window



钢钎
Drilling Steel



空调
Air Conditioner



顶幔
Ceiling Lining



卡式地骨头
Card to the bone



工程灯
Engineering Lamps

