

LACAZ

LIGHTS

LACAZ



ARCHITECTURAL LIGHTING
GENERAL LIGHTING



LACAZ



Moon Series



CE-DD-XZ-L570/1140/1710



CE-DD-FG-L570/1140/1710



CE-DD-GS-C-L570/1140/1710(凹面/Concave)



CE-DD-GS-V-L570/1140/1710(凸面/Convex)

CE-LD-XZ-L1140/1710



CE-LD-FG-L1140/1710



(凹面/Concave) CE-LD-GS-C-L1140/1710



(凸面/Convex) CE-LD-GS-V-L1140/1710



CE-DD-L570
 尺寸 [Size]:630X60mm
 功率 [Power]:15W
 材质 [Material]:Aluminium +PC

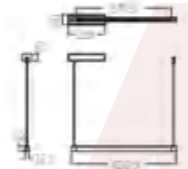

CE-DD-L1140
 尺寸 [Size]:1200x60mm
 功率 [Power]:30W
 材质 [Material]:Aluminium +PC

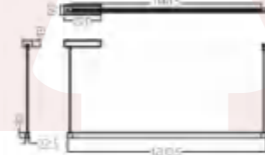

CE-DD-L1710
 尺寸 [Size]:1770x60mm
 功率 [Power]:45W
 材质 [Material]:Aluminium +PC

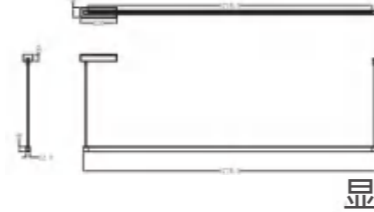

CE-LD-L1140
 尺寸 [Size]:1225X 220mm
 功率 [Power]:30W
 材质 [Material]:Aluminium +PC



CE-LD-L1710
 尺寸 [Size]:1795x 220mm
 功率 [Power]:45W
 材质 [Material]:Aluminium +PC

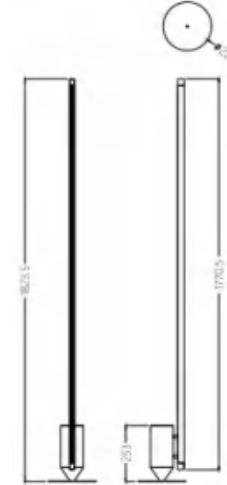

可选颜色种类 / Reflector Colors



可选光学角度 Beam

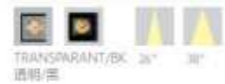

芯片/Chip



可选颜色种类 / Reflector Colors



可选光学角度 Beam



芯片/Chip



 CE-BD-XZ-L570/1140

 CE-BD-FG-L570/1140

 CE-BD-GS-C-L570/1140 (凹面/Concave)

 CE-BD-GS-V-L570/1140 (凸面/Convex)

CE-BD-L570
 尺寸 [Size]:802x60mm
 功率 [Power]:15W
 材质 [Material]:Aluminium +PC



CE-BD-L1140
 尺寸 [Size]:1144x60mm
 功率 [Power]:30W
 材质 [Material]:Aluminium +PC



CE-DD-GD-R03x2
 尺寸 [Size]:570x47.4x131mm
 功率 [Power]:2x8W
 材质 [Material]:Aluminium +PC

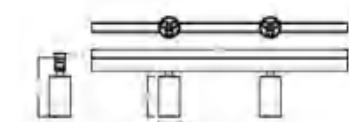

可选光学种类/Optics | 可选光学角度/Beam | 可选灯体颜色/Fixture Colors | 防眩罩可选颜色/Reflector Colors | 芯片/Chip

凸面防眩罩 | 26° 38° | W B HC LC GY G B GN P | 外白内黑 W+B 外白内金 W+G 外黑内金 B+G 全黑 B | Osram3030 CSP SMD



CE-DD-GD-C35x2
 尺寸 [Size]:570x35x94
 功率 [Power]:2x5W
 材质 [Material]:Aluminium +PC

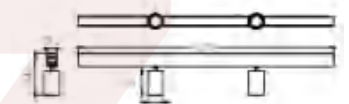

可选光学角度/Beam | 可选灯体颜色/Fixture Colors | 防眩罩可选颜色/Reflector Colors | 芯片/Chip

24° 36° 50° | W B HC LC GY G B GN P | 外白内金 W+G 外黑内金 B+G 全黑 B | CREE CITIZEN COB



CE-DD-GD-C48x2
 尺寸 [Size]:570x47.4x131mm
 功率 [Power]:2x8W
 材质 [Material]:Aluminium +PC

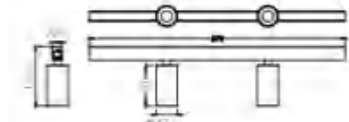

可选颜色种类 / Reflector Colors | 可选光学角度/Beam | 芯片/Chip

WH/BK/WH+GG/BK+GD 26° 38° | TRANSPARENT/BK 26° 38° | Osram3030 CSP SMD

可选光学角度/Beam | 可选灯体颜色/Fixture Colors | 防眩罩可选颜色/Reflector Colors | 芯片/Chip

15° 24° 36° 60° | W B HC LC GY G B GN P | 外白内金 W+G 外黑内金 B+G 全黑 B | CREE CITIZEN COB



CE-DD-GD-R01x2
尺寸 [Size]: 570x22.5x176.5
功率 [Power]: 2x8W
材质 [Material]: Aluminium +PC



CE-DD-GD-R01-400x2
尺寸 [Size]: 570x24mm
功率 [Power]: 2x8W
材质 [Material]: Aluminium +PC

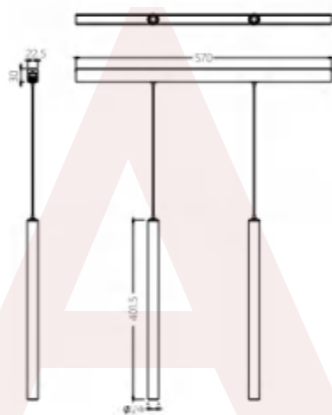

CE-DD-GD-F-R01x2
尺寸 [Size]: 570x89mm
功率 [Power]: 2x8W
材质 [Material]: Aluminium +PC

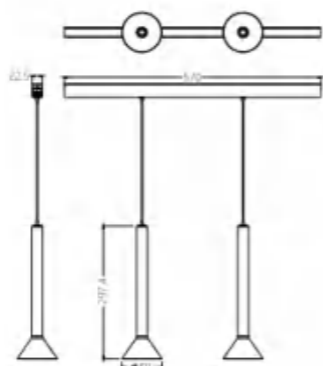

产品配件
ACCESSORIES



场景应用
APPLICATION

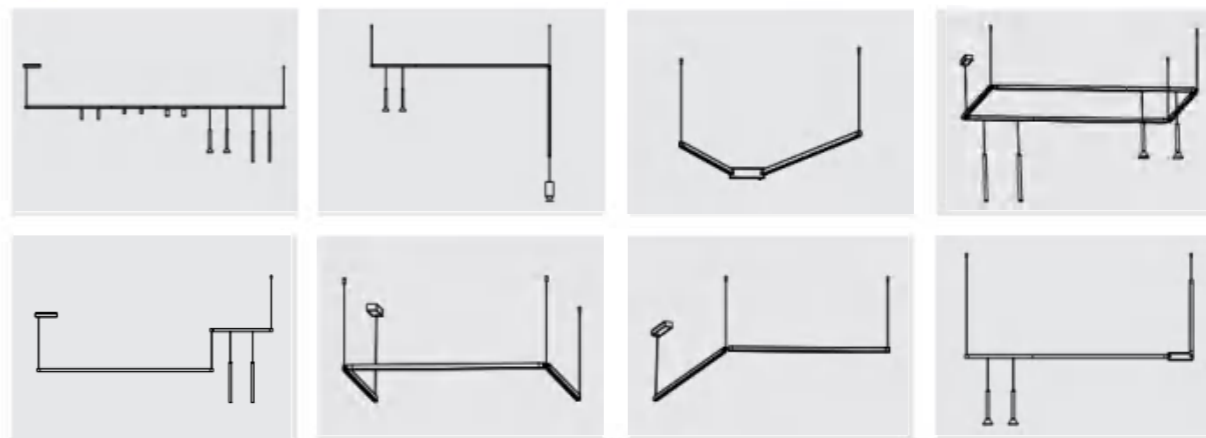

- | | | | | |
|------------------------|-------------------------------------|---|---|--|
| <p>可选光学种类 / Optics</p> | <p>可选光学角度 / Beam</p> <p>26° 38°</p> | <p>可选灯体颜色 / Fixture Colors</p> <p>白 W 灰 B 深灰 HC 浅灰 LC 灰 GY 金 G 蓝 B 绿 GN 粉 P</p> | <p>防眩罩可选颜色 / Reflector Colors</p> <p>黑 R 透明 T</p> | <p>芯片 / Chip</p> <p>SMD Osram 3030 CSP</p> |
|------------------------|-------------------------------------|---|---|--|

LACAZ



嫦娥系列 Moon Series

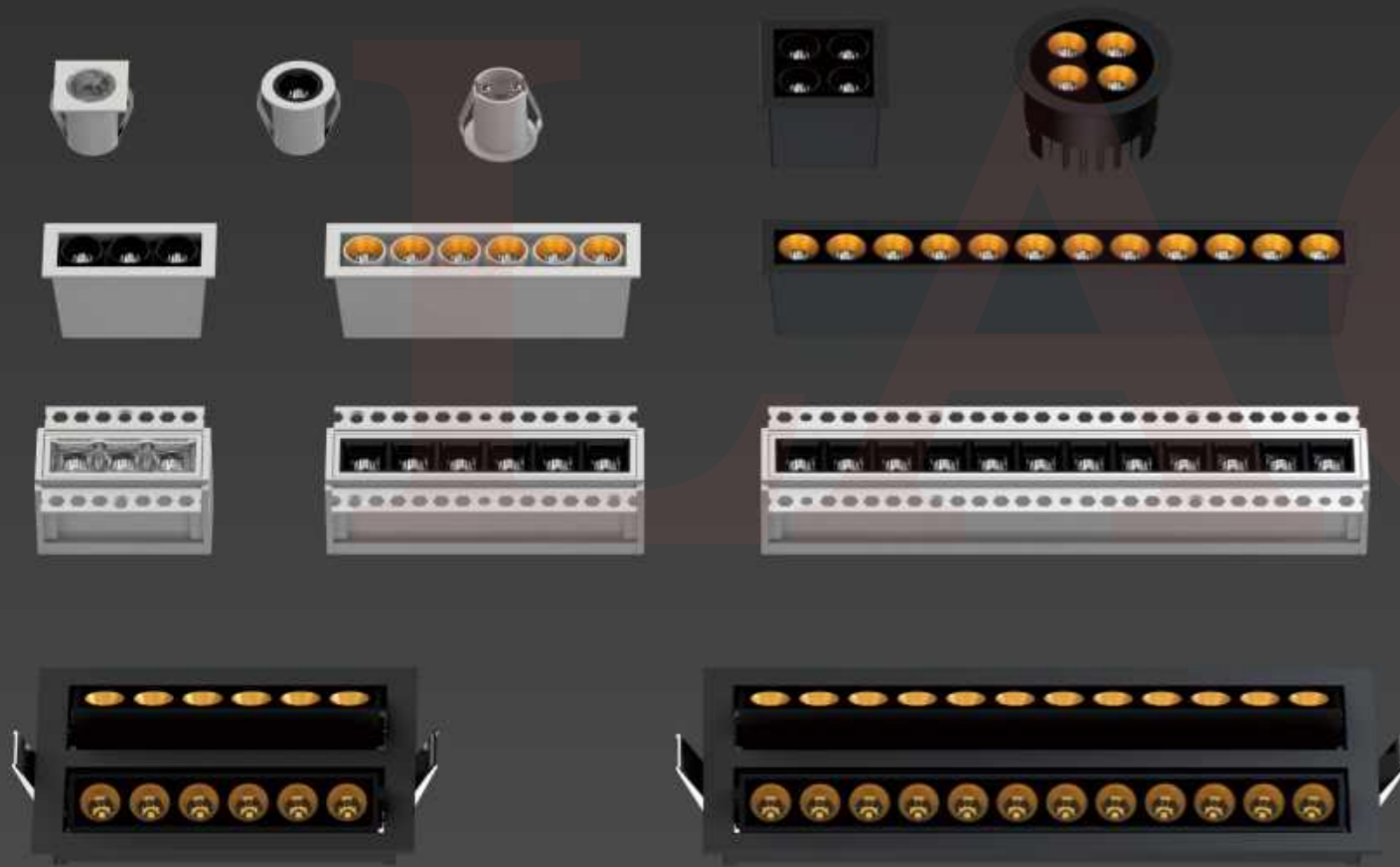

CE-XTD-R01

尺寸 [Size] : $\Phi 30 \times 30 \text{mm}$
 开孔尺寸 [Cut Hole] : $\Phi 25 \text{mm}$
 功率 [Power] : 2W
 材质 [Material] : Die casting aluminium

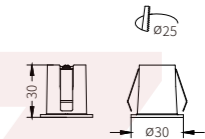

CE-XTD-S01

尺寸 [Size] : $30 \times 30 \text{mm}$
 开孔尺寸 [Cut Hole] : $\Phi 25 \text{mm}$
 功率 [Power] : 2W
 材质 [Material] : Die casting aluminium

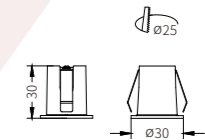

CE-XTD-R04

尺寸 [Size] : $\Phi 65 \times 40 \text{mm}$
 开孔尺寸 [Cut Hole] : $\Phi 60 \text{mm}$
 功率 [Power] : 8W
 材质 [Material] : Die casting aluminium

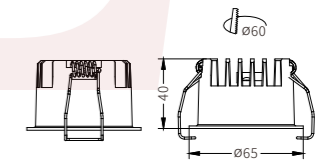

CE-XTD-S04

尺寸 [Size] : $52 \times 52 \times 40 \text{mm}$
 开孔尺寸 [Cut Hole] : $48 \times 48 \text{mm}$
 功率 [Power] : 8W
 材质 [Material] : Die casting aluminium

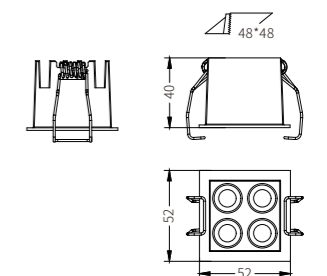

可选光学种类/Optics



凹面防眩罩 凸面防眩罩

可选光学角度/Beam

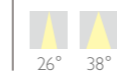

26° 38°

防眩罩可选颜色/Reflector Colors



凹面光学 备注:方圆四头没有此类光学
 外白内黑 W+B 外白内金 W+G 外黑内金 B+G 全黑 B

凸面光学 备注:1头没有此类光学



芯片/Chip



Orsam3030 CSP SMD

Trimless



CE-XTD-B-S03

尺寸 [Size] : 68.6*60*43mm
开孔尺寸 [Cut Hole] : 69.5*37mm
功率 [Power] : 6W
材质 [Material] : Die casting aluminium

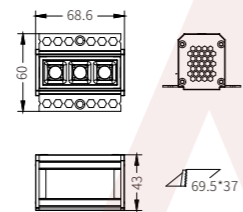

CE-XTD-S06

尺寸 [Size] : 125.6x60x43mm
开孔尺寸 [Cut Hole] : 126.5x37mm
功率 [Power] : 10W
材质 [Material] : Die casting aluminium

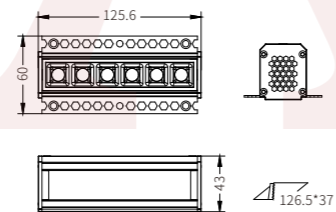

CE-XTD-S12

尺寸 [Size] : 239.6x60x43mm
开孔尺寸 [Cut Hole] : 240.5x37mm
功率 [Power] : 20W
材质 [Material] : Die casting aluminium

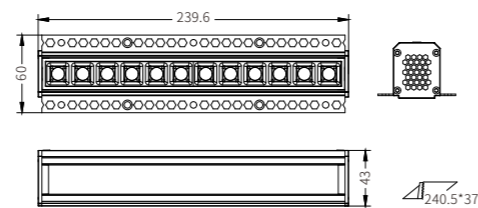

可选光学种类/Optics



可选光学角度/Beam

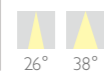

防眩罩可选颜色/Reflector Colors



芯片/Chip

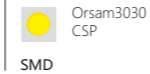

CE-XTD-S03

尺寸 [Size] : 69x31x40mm
开孔尺寸 [Cut Hole] : 65x27mm
功率 [Power] : 6W
材质 [Material] : Die casting aluminium

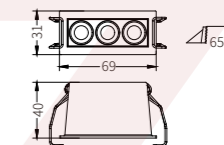

CE-XTD-S06

尺寸 [Size] : 126x31x40mm
开孔尺寸 [Cut Hole] : 122x27mm
功率 [Power] : 10W
材质 [Material] : Die casting aluminium

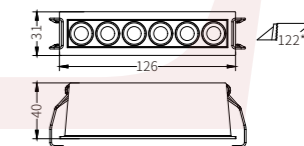

CE-XTD-S12

尺寸 [Size] : 240x31x40mm
开孔尺寸 [Cut Hole] : 236x27mm
功率 [Power] : 20W
材质 [Material] : Die casting aluminium

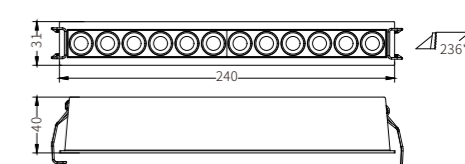

可选光学种类/Optics



可选光学角度/Beam

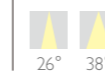

防眩罩可选颜色/Reflector Colors



芯片/Chip



**CE-GSD-S06**

尺寸 [Size] : 141x49x44mm
 开孔尺寸 [Cut Hole] : 136x43mm
 功率 [Power] : 10W
 材质 [Material] : Die casting aluminium

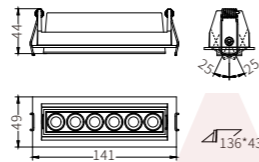
**CE-GSD-S06x2**

尺寸 [Size] : 147x100x44mm
 开孔尺寸 [Cut Hole] : 138x90mm
 功率 [Power] : 2x10W
 材质 [Material] : Die casting aluminium

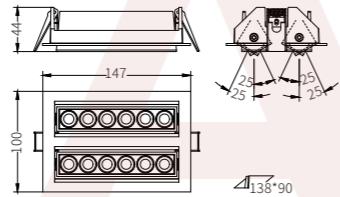
**CE-GSD-S12**

尺寸 [Size] : 255x49x44mm
 开孔尺寸 [Cut Hole] : 250x43mm
 功率 [Power] : 20W
 材质 [Material] : Die casting aluminium

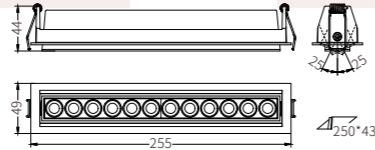
**CE-GSD-S12x2**

尺寸 [Size] : 261x100x44mm
 开孔尺寸 [Cut Hole] : 252x90mm
 功率 [Power] : 2x20W
 材质 [Material] : Die casting aluminium

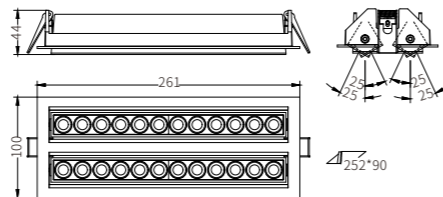

可选光学种类/Optics



凹面防眩罩



凸面防眩罩

可选光学角度/Beam



26°



38°

防眩罩可选颜色/Reflector Colors



黑 B



透明 T

凹面光学



外白内黑 W+B



外白内金 W+G



外黑内金 B+G



全黑 B

凸面光学

芯片/Chip



Orsam3030 CSP

SMD





CE-GD-R03

尺寸 [Size] : $\Phi 47.4 \times 90$ mm
功率 [Power] : 8W
材质 [Material] : Aluminium

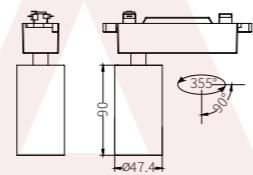

MZ-GD-R04

尺寸 [Size] : $\Phi 54.4 \times 105$ mm
功率 [Power] : 10W
材质 [Material] : Aluminium

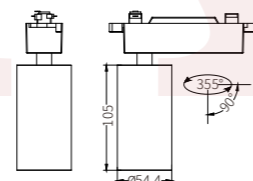

CE-GD-S04

尺寸 [Size] : 44x44x105mm
功率 [Power] : 10W
材质 [Material] : Aluminium

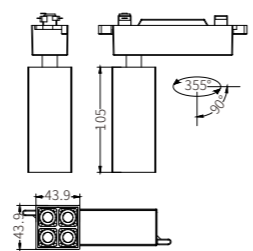

GE-GD-R03-L

尺寸 [Size] : $\Phi 47.4 \times 220$
功率 [Power] : 15W
材质 [Material] : Aluminium

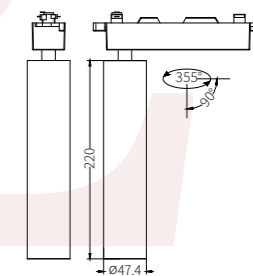

CE-GD-R04-L

尺寸 [Size] : $\Phi 54.4 \times 220$ mm
功率 [Power] : 15W
材质 [Material] : Aluminium

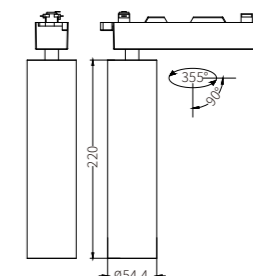

可选光学种类/Optics



凸面防眩罩

可选光学角度/Beam

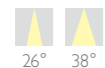

26° 38°

可选灯体颜色/Fixture Colors

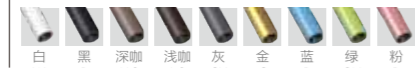

白 W 黑 B 深咖 HC 浅咖 LC 灰 GY 金 G 蓝 B 绿 GN 粉 P

防眩罩可选颜色/Reflector Colors



外白内黑 W+B 外白内金 W+G 外黑内金 B+G 全黑 B

芯片/Chip



Orsam3030 CSP SMD

可选光学种类/Optics



凸面防眩罩

可选光学角度/Beam

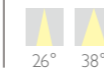

26° 38°

可选灯体颜色/Fixture Colors

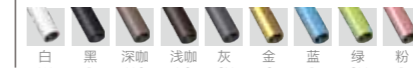

白 W 黑 B 深咖 HC 浅咖 LC 灰 GY 金 G 蓝 B 绿 GN 粉 P

防眩罩可选颜色/Reflector Colors



外白内黑 W+B 外白内金 W+G 外黑内金 B+G 全黑 B

芯片/Chip



Orsam3030 CSP SMD



CE-RI-R-01

尺寸 [Size] : $\Phi 53 \times 177.6 \text{mm}$ ($\Phi 23 \times 138 \text{mm}$)
 开孔尺寸 [Cut Hole] : $\Phi 45 \text{mm}$
 功率 [Power] : 8W
 材质 [Material] : Aluminium

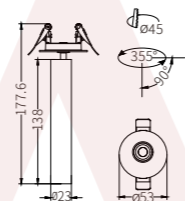

CE-RI-R-02

尺寸 [Size] : $\Phi 75 \times 177.6 \text{mm}$ ($\Phi 23 \times 138 \text{mm}$)
 开孔尺寸 [Cut Hole] : $\Phi 65 \text{mm}$
 功率 [Power] : 2x8W
 材质 [Material] : Aluminium

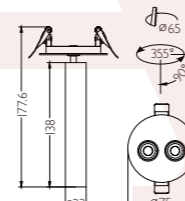

CE-RI-S-01

尺寸 [Size] : $60 \times 60 \times 177.8 \text{mm}$ ($\Phi 23 \times 138 \text{mm}$)
 开孔尺寸 [Cut Hole] : $55 \times 55 \text{mm}$
 功率 [Power] : 8W
 材质 [Material] : Aluminium

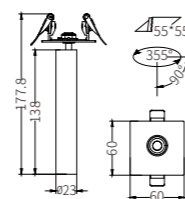

CE-RI-S-02

尺寸 [Size] : $150 \times 60 \times 177.8 \text{mm}$ ($\Phi 23 \times 138 \text{mm}$)
 开孔尺寸 [Cut Hole] : $140 \times 50 \text{mm}$
 功率 [Power] : 2x8W
 材质 [Material] : Aluminium

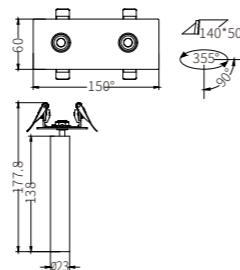

可选光学种类/Optics



凹面防眩罩

可选光学角度/Beam

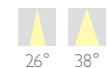

26° 38°

可选灯体颜色/Fixture Colors

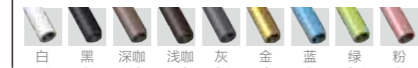

防眩罩可选颜色/Reflector Colors

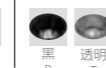

黑 透明

芯片/Chip



SMD Orsam3030 CSP



CE-RI-S-03

尺寸 [Size] : $265 \times 60 \times 177.8 \text{mm}$
 ($\Phi 23 \times 138 \text{mm}$)
 开孔尺寸 [Cut Hole] : $255 \times 50 \text{mm}$
 功率 [Power] : 3x8W
 材质 [Material] : Aluminium

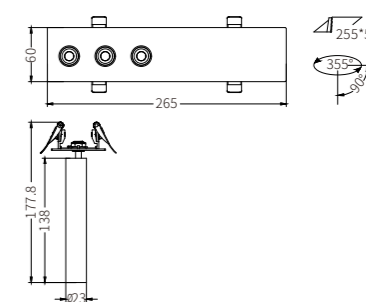

CE-RI-M-01

尺寸 [Size] : $220 \times 60 \times 183.6 \text{mm}$
 ($\Phi 23 \times 138 \text{mm}$)
 功率 [Power] : 8W
 材质 [Material] : Aluminium

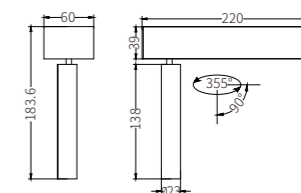

CE-RI-M-02

尺寸 [Size] : $250 \times 60 \times 183.6 \text{mm}$
 ($\Phi 23 \times 138 \text{mm}$)
 功率 [Power] : 2x8W
 材质 [Material] : Aluminium

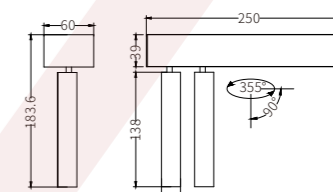

CE-RI-M-03

尺寸 [Size] : $300 \times 60 \times 183.6 \text{mm}$
 ($\Phi 23 \times 138 \text{mm}$)
 功率 [Power] : 3x8W
 材质 [Material] : Aluminium

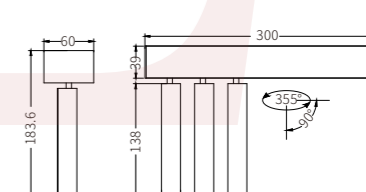

CE-R01-LS-A

尺寸 [Size] : $\Phi 62 \times 251.5 \text{mm}$
 开孔尺寸 [Cut Hole] : $\Phi 55 \text{mm}$
 功率 [Power] : 8W
 材质 [Material] : Aluminium

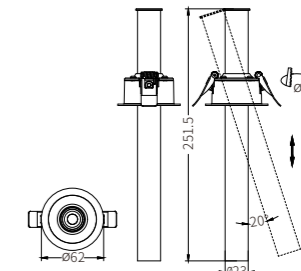

可选光学种类/Optics



凹面防眩罩

可选光学角度/Beam

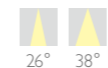

26° 38°

可选灯体颜色/Fixture Colors

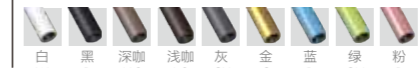

防眩罩可选颜色/Reflector Colors

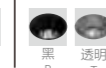

黑 透明

芯片/Chip



SMD Orsam3030 CSP



CE-C48-R-01

尺寸 [Size] : $\Phi 53 \times 132.7 \text{mm}$ ($\Phi 47.4 \times 90 \text{mm}$)
 开孔尺寸 [Cut Hole] : $\Phi 45 \text{mm}$
 功率 [Power] : 8W
 材质 [Material] : Aluminium

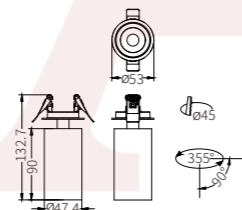

CE-C48-S-01

尺寸 [Size] : $60 \times 60 \times 132.7 \text{mm}$ ($\Phi 47.4 \times 90 \text{mm}$)
 开孔尺寸 [Cut Hole] : $50 \times 50 \text{mm}$
 功率 [Power] : 8W
 材质 [Material] : Aluminium

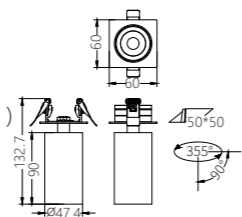

CE-C48-S-02

尺寸 [Size] : $300 \times 60 \times 132.7 \text{mm}$
 ($\Phi 47.4 \times 90 \text{mm}$)
 开孔尺寸 [Cut Hole] : $290 \times 50 \text{mm}$
 功率 [Power] : $2 \times 8 \text{W}$
 材质 [Material] : Aluminium

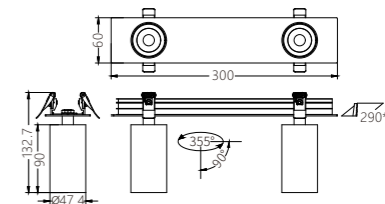

CE-C48-S-03

尺寸 [Size] : $400 \times 60 \times 132.7 \text{mm}$
 ($\Phi 47.4 \times 90 \text{mm}$)
 开孔尺寸 [Cut Hole] : $390 \times 50 \text{mm}$
 功率 [Power] : $3 \times 8 \text{W}$
 材质 [Material] : Aluminium

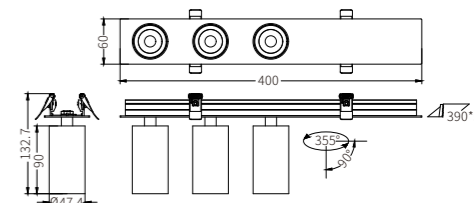

CE-C48-M-01

尺寸 [Size] : $220 \times 60 \times 138.7 \text{mm}$
 ($\Phi 47.4 \times 90 \text{mm}$)
 功率 [Power] : 8W
 材质 [Material] : Aluminium

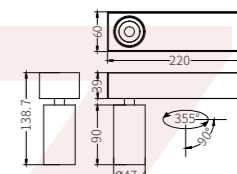

CE-C48-M-02

尺寸 [Size] : $300 \times 60 \times 138.7 \text{mm}$
 ($\Phi 47.4 \times 90 \text{mm}$)
 功率 [Power] : $2 \times 8 \text{W}$
 材质 [Material] : Aluminium

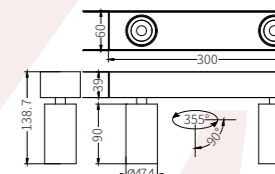

CE-C48-M-03

尺寸 [Size] : $400 \times 60 \times 138.7 \text{mm}$
 ($\Phi 47.4 \times 90 \text{mm}$)
 功率 [Power] : $3 \times 8 \text{W}$
 材质 [Material] : Aluminium

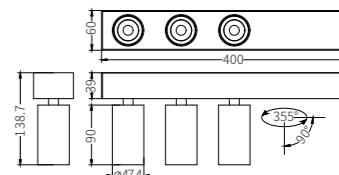

CE-C48-GD

尺寸 [Size] : $\Phi 47.4 \times 90 \text{mm}$
 功率 [Power] : 8W
 材质 [Material] : Aluminium

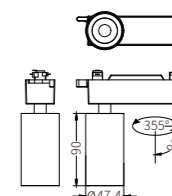

可选光学角度/Beam

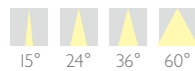

可选灯体颜色/Fixture Colors

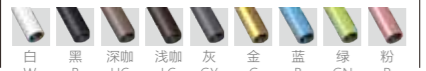

防眩罩可选颜色/Reflector Colors



芯片/Chip



可选光学角度/Beam

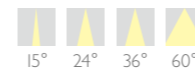

可选灯体颜色/Fixture Colors

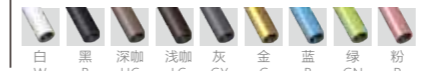

防眩罩可选颜色/Reflector Colors



芯片/Chip





CE-R3-R-01

尺寸 [Size] : $\Phi 53 \times 132.7 \text{mm}$ ($\Phi 47.4 \times 90 \text{mm}$)
 开孔尺寸 [Cut Hole] : $\Phi 45 \text{mm}$
 功率 [Power] : 8W
 材质 [Material] : Aluminium

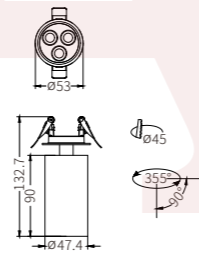

CE-R3-S-01

尺寸 [Size] : $60 \times 60 \times 132.7 \text{mm}$ ($\Phi 47.4 \times 90 \text{mm}$)
 开孔尺寸 [Cut Hole] : $50 \times 50 \text{mm}$
 功率 [Power] : 8W
 材质 [Material] : Aluminium

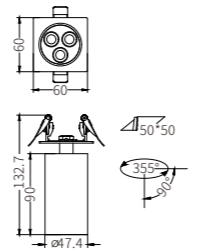

CE-R3-S-02

尺寸 [Size] : $300 \times 60 \times 132.7 \text{mm}$
 ($\Phi 47.4 \times 90 \text{mm}$)
 开孔尺寸 [Cut Hole] : $290 \times 50 \text{mm}$
 功率 [Power] : 2x8W
 材质 [Material] : Aluminium

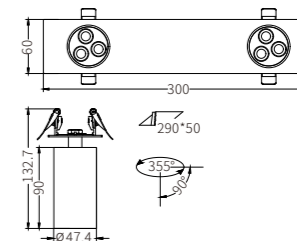

CE-R3-S-03

尺寸 [Size] : $400 \times 60 \times 132.7 \text{mm}$
 ($\Phi 47.4 \times 90 \text{mm}$)
 开孔尺寸 [Cut Hole] : $390 \times 50 \text{mm}$
 功率 [Power] : 3x8W
 材质 [Material] : Aluminium

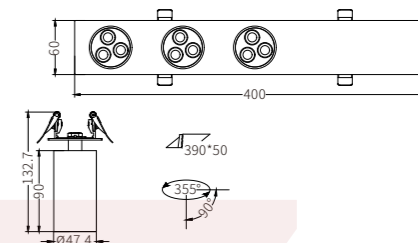

CE-R3-M-01

尺寸 [Size] : $220 \times 60 \times 138.7 \text{mm}$
 ($\Phi 47.4 \times 90 \text{mm}$)
 功率 [Power] : 8W
 材质 [Material] : Aluminium

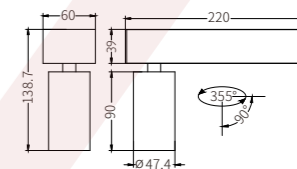

CE-R3-M-02

尺寸 [Size] : $300 \times 60 \times 138.7 \text{mm}$
 ($\Phi 47.4 \times 90 \text{mm}$)
 功率 [Power] : 2x8W
 材质 [Material] : Aluminium

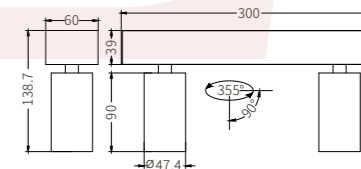

CE-R3-M-03

尺寸 [Size] : $400 \times 60 \times 138.7 \text{mm}$
 ($\Phi 47.4 \times 90 \text{mm}$)
 功率 [Power] : 3x8W
 材质 [Material] : Aluminium

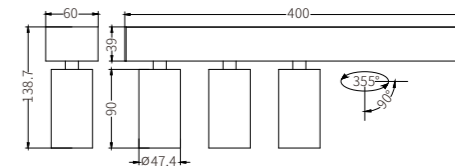

可选光学种类/Optics



凸面防眩罩

可选光学角度/Beam



26° 38°

可选灯体颜色/Fixture Colors

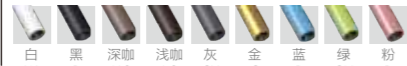

白 W 黑 B 深咖 HC 浅咖 LC 灰 GY 金 G 蓝 B 绿 GN 粉 P

防眩罩可选颜色/Reflector Colors



外白内黑 W+B 外白内金 W+G 外黑内金 B+G 全黑 B

芯片/Chip



SMD

Orsam3030 CSP

可选光学种类/Optics



凸面防眩罩

可选光学角度/Beam



26° 38°

可选灯体颜色/Fixture Colors

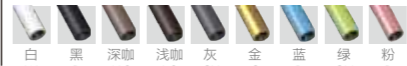

白 W 黑 B 深咖 HC 浅咖 LC 灰 GY 金 G 蓝 B 绿 GN 粉 P

防眩罩可选颜色/Reflector Colors



外白内黑 W+B 外白内金 W+G 外黑内金 B+G 全黑 B

芯片/Chip



SMD

Orsam3030 CSP



CE-R4-R-01

尺寸 [Size] : $\Phi 53 \times 147.7 \text{mm}$ ($\Phi 54.4 \times 105 \text{mm}$)
 开孔尺寸 [Cut Hole] : $\Phi 45 \text{mm}$
 功率 [Power] : 10W
 材质 [Material] : Aluminium

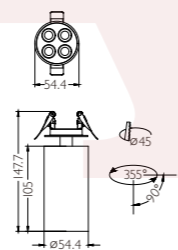

CE-R4-S-01

尺寸 [Size] : $60 \times 60 \times 147.7 \text{mm}$ ($\Phi 54.4 \times 105 \text{mm}$)
 开孔尺寸 [Cut Hole] : $50 \times 50 \text{mm}$
 功率 [Power] : 10W
 材质 [Material] : Aluminium

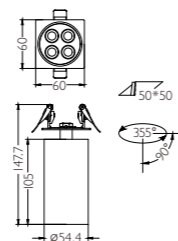

CE-R4-S-02

尺寸 [Size] : $300 \times 60 \times 147.7 \text{mm}$
 ($\Phi 54.4 \times 105 \text{mm}$)
 开孔尺寸 [Cut Hole] : $290 \times 50 \text{mm}$
 功率 [Power] : $2 \times 10 \text{W}$
 材质 [Material] : Aluminium

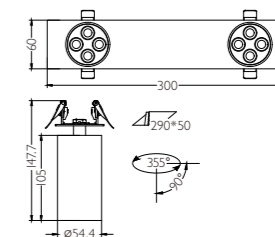

CE-R4-S-03

尺寸 [Size] : $400 \times 60 \times 147.7 \text{mm}$
 ($\Phi 54.4 \times 105 \text{mm}$)
 开孔尺寸 [Cut Hole] : $390 \times 50 \text{mm}$
 功率 [Power] : $3 \times 10 \text{W}$
 材质 [Material] : Aluminium

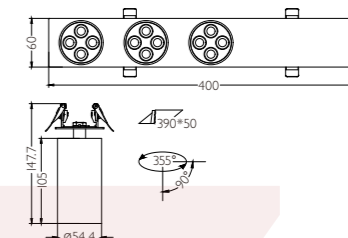

CE-R4-M-01

尺寸 [Size] : $220 \times 60 \times 153.7 \text{mm}$
 ($\Phi 54.4 \times 105 \text{mm}$)
 功率 [Power] : 10W
 材质 [Material] : Aluminium

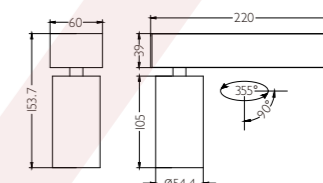

CE-R4-M-02

尺寸 [Size] : $300 \times 60 \times 153.7 \text{mm}$
 ($\Phi 54.4 \times 105 \text{mm}$)
 功率 [Power] : $2 \times 10 \text{W}$
 材质 [Material] : Aluminium

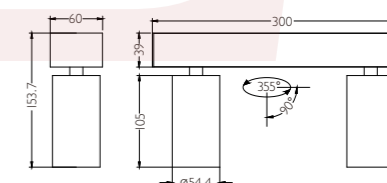

CE-R4-M-03

尺寸 [Size] : $400 \times 60 \times 153.7 \text{mm}$
 ($\Phi 54.4 \times 105 \text{mm}$)
 功率 [Power] : $3 \times 10 \text{W}$
 材质 [Material] : Aluminium

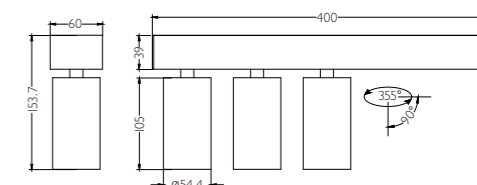

可选光学种类/Optics



凸面防眩罩

可选光学角度/Beam



26° 38°

可选灯体颜色/Fixture Colors

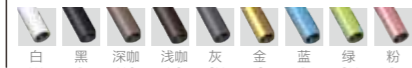

白 W 黑 B 深咖 HC 浅咖 LC 灰 GY 金 G 蓝 B 绿 GN 粉 P

防眩罩可选颜色/Reflector Colors



外白内黑 W+B 外白内金 W+G 外黑内金 B+G 全黑 B

芯片/Chip



Orsam3030 CSP SMD

可选光学种类/Optics



凸面防眩罩

可选光学角度/Beam



26° 38°

可选灯体颜色/Fixture Colors

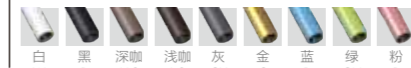

白 W 黑 B 深咖 HC 浅咖 LC 灰 GY 金 G 蓝 B 绿 GN 粉 P

防眩罩可选颜色/Reflector Colors



外白内黑 W+B 外白内金 W+G 外黑内金 B+G 全黑 B

芯片/Chip



Orsam3030 CSP SMD



CE-S4-R-01

尺寸 [Size] : $\Phi 53 \times 147.7 \text{mm}$
(44x44x105mm)
开孔尺寸 [Cut Hole] : $\Phi 45 \text{mm}$
功率 [Power] : 10W
材质 [Material] : Aluminium

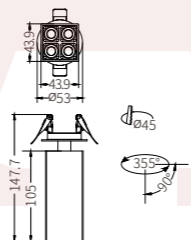

CE-S4-S-01

尺寸 [Size] : $60 \times 60 \times 147.7 \text{mm}$
(44x44x105mm)
开孔尺寸 [Cut Hole] : $50 \times 50 \text{mm}$
[Power] : 10W
材质 [Material] : Aluminium

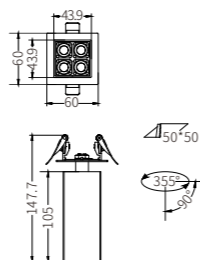

CE-S4-S-02

尺寸 [Size] : $300 \times 60 \times 147.7 \text{mm}$
(44x44x105mm)
开孔尺寸 [Cut Hole] : $290 \times 50 \text{mm}$
功率 [Power] : 2x10W
材质 [Material] : Aluminium

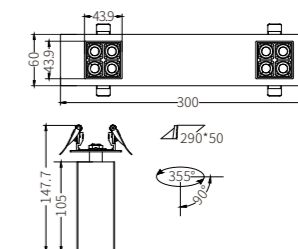

CE-SE-S-03

尺寸 [Size] : $400 \times 60 \times 147.7 \text{mm}$
(44x44x105mm)
开孔尺寸 [Cut Hole] : $390 \times 50 \text{mm}$
功率 [Power] : 3x10W
材质 [Material] : Aluminium

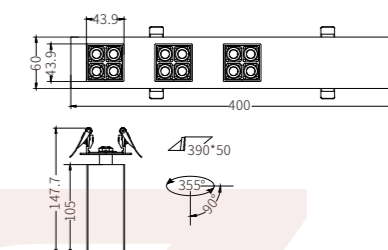

CE-S4-M-01

尺寸 [Size] : $220 \times 60 \times 153.7 \text{mm}$
(44x44x105mm)
功率 [Power] : 10W
材质 [Material] : Aluminium

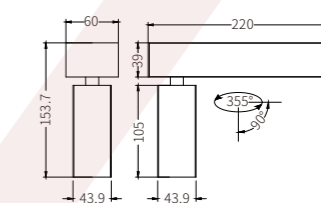

CE-S4-M-02

尺寸 [Size] : $300 \times 60 \times 153.7 \text{mm}$
(44x44x105mm)
功率 [Power] : 2x10W
材质 [Material] : Aluminium

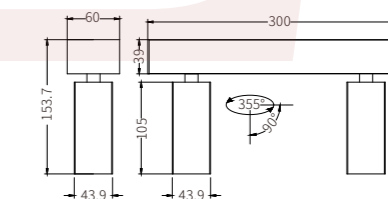

CE-S4-M-03

尺寸 [Size] : $400 \times 60 \times 153.7 \text{mm}$
(44x44x105mm)
功率 [Power] : 3x10W
材质 [Material] : Aluminium

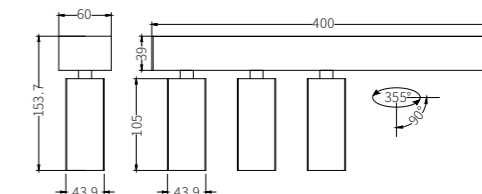

可选光学种类/Optics



凸面防眩罩

可选光学角度/Beam

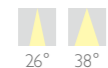

26° 38°

可选灯体颜色/Fixture Colors

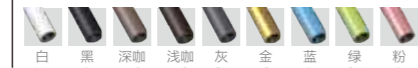

白 W 黑 B 深咖 HC 浅咖 LC 灰 GY 金 G 蓝 B 绿 GN 粉 P

防眩罩可选颜色/Reflector Colors



外白内黑 W+B 外白内金 W+G 外黑内金 B+G 全黑 B

芯片/Chip



Orsam3030 CSP SMD

可选光学种类/Optics



凸面防眩罩

可选光学角度/Beam

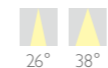

26° 38°

可选灯体颜色/Fixture Colors

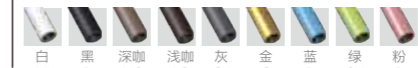

白 W 黑 B 深咖 HC 浅咖 LC 灰 GY 金 G 蓝 B 绿 GN 粉 P

防眩罩可选颜色/Reflector Colors



外白内黑 W+B 外白内金 W+G 外黑内金 B+G 全黑 B

芯片/Chip



Orsam3030 CSP SMD



CE-WX-R03-A
 尺寸 [Size] : $\Phi 105 \times 108.8 \text{mm} (\Phi 54.4 \times 76.4 \text{mm})$
 开孔尺寸 [Cut Hole] : $\Phi 95 \text{mm}$
 功率 [Power] : 8W
 材质 [Material] : Aluminium

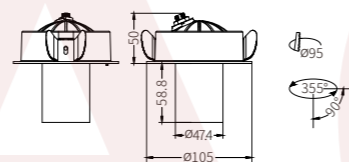

CE-WX-R04-A
 尺寸 [Size] : $\Phi 105 \times 126.4 \text{mm} (\Phi 54.4 \times 76.4 \text{mm})$
 开孔尺寸 [Cut Hole] : $\Phi 95 \text{mm}$
 功率 [Power] : 10W
 材质 [Material] : Aluminium

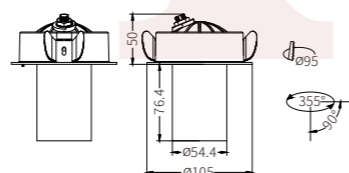

CE-LM-R03-SD
 尺寸 [Size] : $\Phi 47.4 \times 263.7 \text{mm}$
 功率 [Power] : 8W
 材质 [Material] : Aluminium

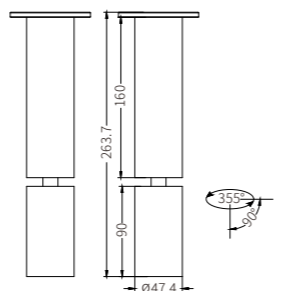

可选光学种类/Optics



凸面防眩罩

可选光学角度/Beam



26° 38°

可选灯体颜色/Fixture Colors

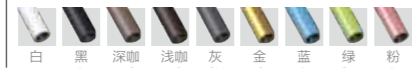

白 W 黑 B 深咖 HC 浅咖 LC 灰 GY 金 G 蓝 B 绿 GN 粉 P

防眩罩可选颜色/Reflector Colors



外白内黑 W+B 外白内金 W+G 外黑内金 B+G 全黑 B

芯片/Chip



SMD Orsam3030 CSP



CE-LM-S04
 尺寸 [Size] : $44 \times 44 \times 220 \text{mm}$
 功率 [Power] : 15W
 材质 [Material] : Aluminium

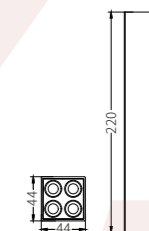

CE-LM-R04
 尺寸 [Size] : $\Phi 54.4 \times 220 \text{mm}$
 功率 [Power] : 15W
 材质 [Material] : Aluminium

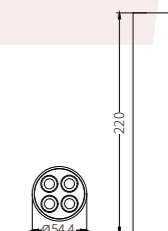

CE-LM-R03
 尺寸 [Size] : $\Phi 47.4 \times 220 \text{mm}$
 功率 [Power] : 15W
 材质 [Material] : Aluminium

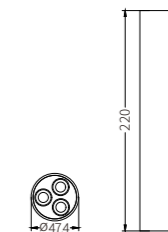

可选光学种类/Optics



凸面防眩罩

可选光学角度/Beam



26° 38°

可选灯体颜色/Fixture Colors

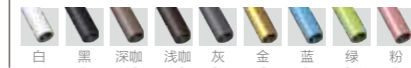

白 W 黑 B 深咖 HC 浅咖 LC 灰 GY 金 G 蓝 B 绿 GN 粉 P

防眩罩可选颜色/Reflector Colors



外白内黑 W+B 外白内金 W+G 外黑内金 B+G 全黑 B

芯片/Chip



SMD Orsam3030 CSP

LACAZ

Magnetic Series



**CX-DD-F-R01**

尺寸 [Size] : $\Phi 89 \times 297.4 \text{mm}$
 功率 [Power] : 8W
 材质 [Material] : Aluminium

**CX-DD-R01-400**

尺寸 [Size] : $\Phi 24 \times 401.5 \text{mm}$
 功率 [Power] : 8W
 材质 [Material] : Aluminium

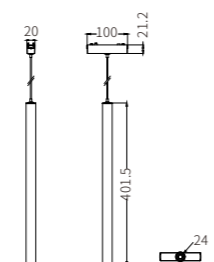
**CX-GD-R01**

尺寸 [Size] : $100 \times 20 \times 168.3 \text{mm}$
 ($\Phi 23 \times 138 \text{mm}$)
 功率 [Power] : 8W
 材质 [Material] : Aluminium

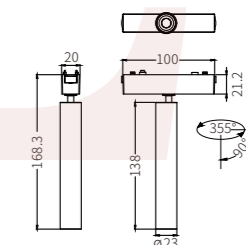
**CE-GD-R01x2**

尺寸 [Size] : $140 \times 20 \times 168.3 \text{mm}$
 ($\Phi 23 \times 138 \text{mm}$)
 功率 [Power] : 2x8W
 材质 [Material] : Aluminium

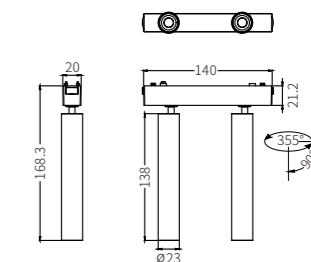

可选光学种类/Optics



凹面防眩罩

可选光学角度/Beam

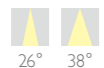

26° 38°

可选灯体颜色/Fixture Colors

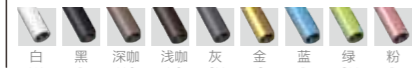

白 W 黑 B 深咖 HC 浅咖 LC 灰 GY 金 G 蓝 B 绿 GN 粉 P

防眩罩可选颜色/Reflector Colors

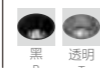

黑 B 透明 T

芯片/Chip



Orsam3030 CSP SMD

可选光学种类/Optics



凹面防眩罩

可选光学角度/Beam

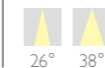

26° 38°

可选灯体颜色/Fixture Colors

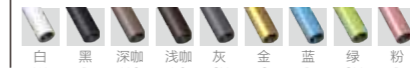

白 W 黑 B 深咖 HC 浅咖 LC 灰 GY 金 G 蓝 B 绿 GN 粉 P

防眩罩可选颜色/Reflector Colors



黑 B 透明 T

芯片/Chip



Orsam3030 CSP SMD



CX-GD-C35

尺寸 [Size] : 100x20x85.7mm
(Φ35x55mm)
功率 [Power] : 5W
材质 [Material] : Aluminium

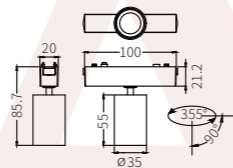

CX-GD-C48

尺寸 [Size] : 100x20x122.9mm
(Φ47.4x90mm)
功率 [Power] : 8W
材质 [Material] : Aluminium

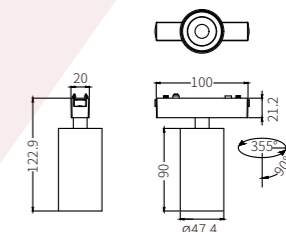

CX-GD-C35x2

尺寸 [Size] : 140x20x85.7mm
(Φ35x55mm)
功率 [Power] : 2x5W
材质 [Material] : Aluminium

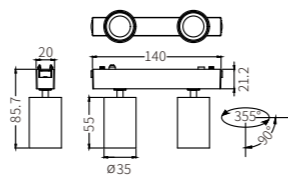

CX-GD-R03

尺寸 [Size] : 100x20x122.9mm
(Φ47.4x122.9mm)
功率 [Power] : 8W
材质 [Material] : Aluminium

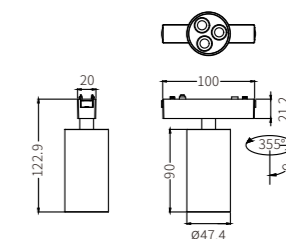

可选光学角度/Beam

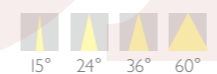

可选灯体颜色/Fixture Colors



防眩罩可选颜色/Reflector Colors



芯片/Chip



可选光学角度/Beam

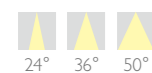

可选灯体颜色/Fixture Colors

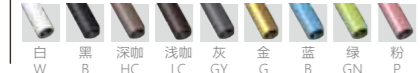

防眩罩可选颜色/Reflector Colors



芯片/Chip



可选光学种类/Optics



可选光学角度/Beam

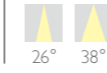

可选灯体颜色/Fixture Colors

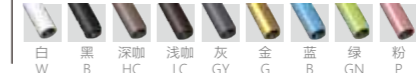

防眩罩可选颜色/Reflector Colors



芯片/Chip



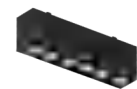

CX-XTD-GS-06

尺寸 [Size] : 118.1x23.3x32.9mm
 功率 [Power] : 10W
 材质 [Material] : Aluminium

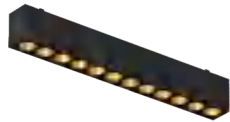
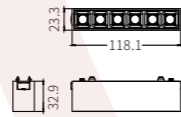

CX-XTD-GS-12

尺寸 [Size] : 232.2x23.3x32.9mm
 功率 [Power] : 20W
 材质 [Material] : Aluminium

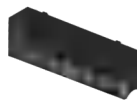
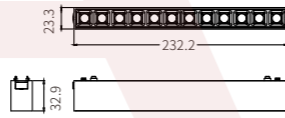

CX-XTD-XZ-06

尺寸 [Size] : 118.1x23.3x32.9mm
 功率 [Power] : 10W
 材质 [Material] : Aluminium

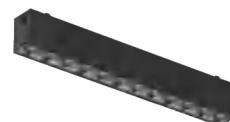
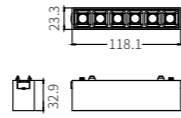

CX-XTD-XZ-12

尺寸 [Size] : 232.2x23.3x32.9mm
 功率 [Power] : 20W
 材质 [Material] : Aluminium

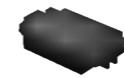
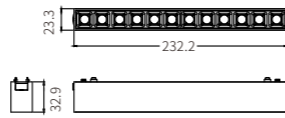

CX-C-I

尺寸 [Size] : 36x20x6.3mm
 材质 [Material] : PC

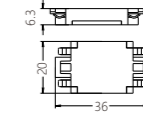

CX-C-T

尺寸 [Size] : 36x28x6.3mm
 材质 [Material] : PC

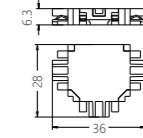

CX-C-X

尺寸 [Size] : 36x36x6.3mm
 材质 [Material] : PC

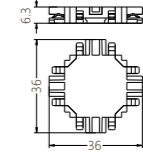

CX-C-C

尺寸 [Size] : 28x28x6.3mm
 材质 [Material] : PC

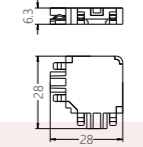

CX-C-L

尺寸 [Size] : 26x26x6.3mm
 (26x20mm)
 材质 [Material] : PC

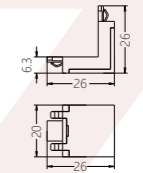

CX-M-G

尺寸 [Size] : 20x6.3mm
 材质 [Material] : PC

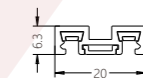

CX-G-C

尺寸 [Size] : 20x4mm
 材质 [Material] : PC

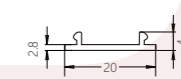

CX-G-JT

尺寸 [Size] : 2.9x3mm
 材质 [Material] : PC



CX-G-C

尺寸 [Size] : 75.9x30.4x20mm
 材质 [Material] : PC

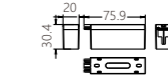

CX-100W电源

尺寸 [Size] : 256.3x24.2x20mm
 材质 [Material] : PC

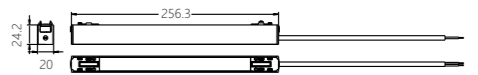

CX-200W电源

尺寸 [Size] : 323.8x24.2x20mm
 材质 [Material] : PC

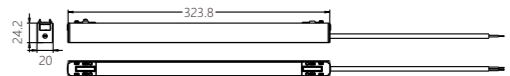

可选颜色种类 / Reflector Colors



可选光学角度/Beam



芯片/Chip

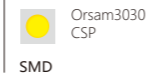

NEW

AW-XTD10

LACAZ

NEW

AW-XTD10-B



Trimless



1 LED | 5W

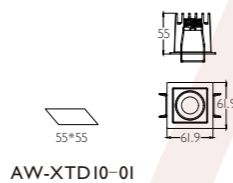

AW-XTD10-01



1 LED | 5W

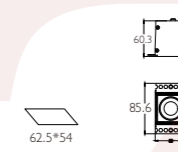

AW-XTD10-B-01



3 LED | 15W



AW-XTD10-03

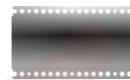

3 LED | 15W

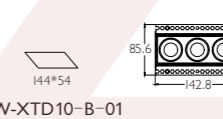

AW-XTD10-B-01



6 LED | 30W

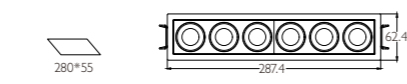

AW-XTD10-06



6 LED | 30W

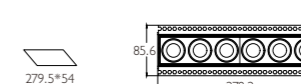

AW-XTD10-B-01

光学角度/Beam

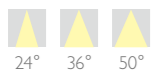

24° 36° 50°

可选配件/Accessories



蜂窝网

芯片/Chip



SMD

光学角度/Beam



24° 36° 50°

可选配件/Accessories



蜂窝网

芯片/Chip



SMD



按需组合
随心所欲

Linear modular Series



MZ-R-A

尺寸 [Size] : 44.3x44.3x55mm
功率 [Power] : 5W
材质 [Material] : Die casting aluminium+PC

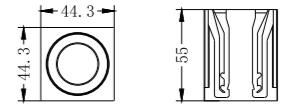

MZ-S-A

尺寸 [Size] : 44.3x44.3x55mm
功率 [Power] : 5W
材质 [Material] : Die casting aluminium+PC

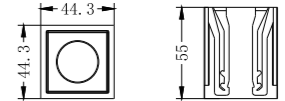

MZ-WW

尺寸 [Size] : 44.3x44.3x80.3mm
功率 [Power] : 5W
材质 [Material] : Die casting aluminium+PC

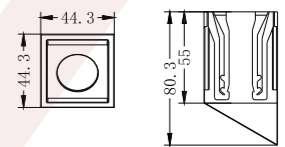

MZ-GD

尺寸 [Size] : 44.3x44.3x119mm
功率 [Power] : 5W
材质 [Material] : Die casting aluminium+PC

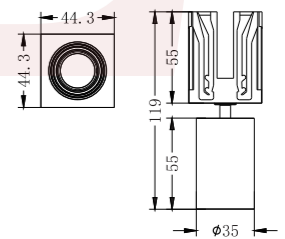

MZ-C

尺寸 [Size] : 44.3x44.3x55mm
材质 [Material] : PC

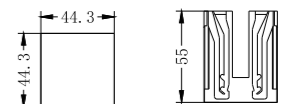

可选灯体颜色/Fixture Colors



黑/B 白/W 金/G

可选配件/Accessories



短遮光罩 长遮光罩 蜂窝网

可选光学角度/Beam

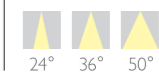

24° 36° 50°

芯片/Chip

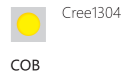

Cree1304
COB

LACAZ



MZ-R-Z

尺寸[Size]:44.3x44.3x62.5mm
功率 [Power]:5W
材质 [Material]:Die casting aluminium+PC



MZ-S-Z

尺寸[Size]:44.3x44.3x62.5mm
功率 [Power]:5W
材质 [Material]:Die casting aluminium+PC



MZ-R-X

尺寸[Size]:44.3x44.3x62.5mm
功率 [Power]:5W
材质[Material]:Die casting aluminium+PC



MZ-S-X

尺寸[Size]:44.3x44.3x62.5mm
功率 [Power]:5W
材质[Material]:Die casting aluminium+PC



MZ-A

尺寸[Size]:44.3x44.3x63mm
功率 [Power]:5W
材质[Material]:Die casting aluminium+PC



MZ-XZ-02

尺寸[Size]:88.7x44.3x55mm
功率 [Power]:2x4W
材质 [Material]:Die casting aluminium+PC

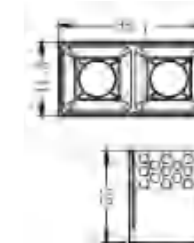

MZ-XZ-04

尺寸 [Size]:177.8x44.3x55mm
功率 [Power]:4x4W
材质 [Material]:Die casting aluminium+PC

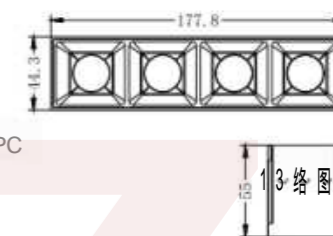

可选灯体颜色/Fixture Colors



可选配件/Accessories



可选光学角度/Beam



芯片/Chip



可选灯体颜色/Fixture Colors



防眩罩可选颜色/Reflector Colors



可选配件/Accessories



可选光学角度/Beam

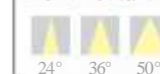

芯片/Chip



LACAZ



MZ-F-01

尺寸[Size]:64x64x55.5mm
开孔尺寸[Cut Hole]:55*55mm
材质[Material]:Die casting aluminium+POM

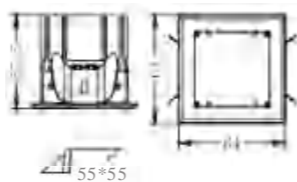

MZ-F-02

尺寸[Size]:108.5x64x55.5mm
开孔尺寸[Cut Hole]:100*55mm
材质[Material]:Die casting aluminium+POM



MZ-F-03

尺寸[Size]:153x64x55.5mm
开孔尺寸[Cut Hole]:144*55mm
材质[Material]:Die casting aluminium+POM

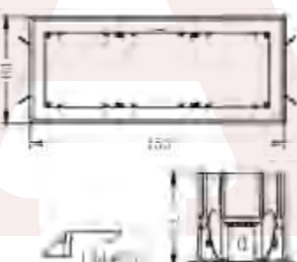

MZ-F-04

尺寸 [Size]:197.5x64x55.5mm
开孔尺寸[Cut Hole]:189*55mm
材质[Material]:Die casting aluminium+POM

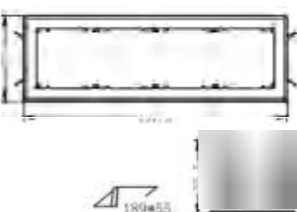

可选面环颜色/Frame Colors



MZ-E-01

尺寸[Size]:88x88x55.5mm
开孔尺寸[Cut Hole]:63*63mm
材质 [Material]:PC+POM

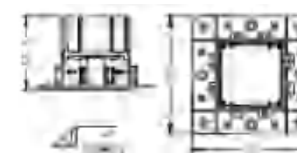

MZ-E-02

尺寸[Size]:132.5x88x55.5mm
开孔尺寸 [Cut Hole]:110*63mm
材质 [Material]:PC+POM

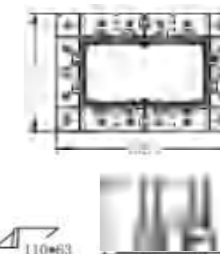

MZ-E-03

尺寸 [Size]:177x88x55.5mm
开孔尺寸 [Cut Hole]:153*63mm
材质 [Material]:PC+POM



MZ-E-04

尺寸 [Size]:221.5x88x55.5mm
开孔尺寸[Cut Hole]:198*63mm
材质 [Material]:PC+POM

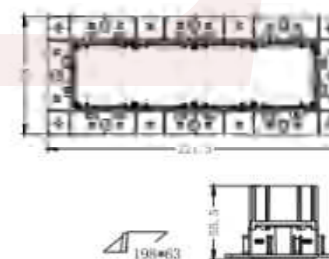

无边组合(DIY)

面环颜色/Frame Colors





TD 069-55

尺寸[Size]:中62x25mm
开孔尺寸 [Cut Hole]: 55mm
功率[Power]:5W
材质[Material]:Die casting aluminium



TD 069-65

尺寸[Size]:中72x28.3mm
开孔尺寸[Cut Hole]:中65mm
功率[Power]:9W
材质[Material]:Die casting aluminium



TD069-75

尺寸[Size]: 83x31.1mm
开孔尺寸[Cut Hole]:中75mm
功率 Power]:12W
材质[Material]:Die casting aluminium



TD 069-95

尺寸[Size]: 105x34.4mm
开孔尺寸[Cut Hole]: 95mm
功率 [Power]:15W
材质 [Material]:Die casting aluminium

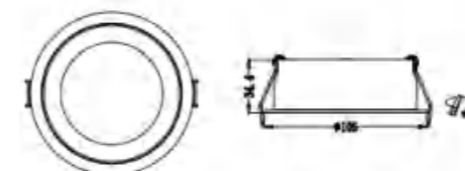

一体化超薄设计

支持调光调色



可选光学角度/Beam



防眩罩可选颜色/Reflector Colors



芯片/Chip





小巧 一掌 小 能



TD068-55

尺寸[Size]: 60x35.5mm
开孔尺寸[Cut Hole]: 55mm
功率 [Power]: 6W
材质[Material]: Die casting aluminium

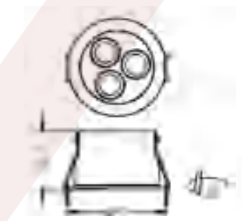

TD068-70

尺寸[Size]: 中80x50.5mm
开孔尺寸 [Cut Hole]: 70mm
功率 [Power]: 12W
材质[Material]: Die casting aluminium

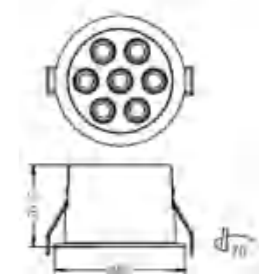

— 1068 —
适用空间 博物馆 别墅 酒店等

可选光学角度/Beam



防眩罩可选颜色/Reflector Colors



芯片/Chip





NMW-HGD-54

功率 [Power]: 10W

NMW-HGD-68

功率 [Power] 20W

NMW-HGD-85

功率 [Power] 30W

隐藏式轨道灯

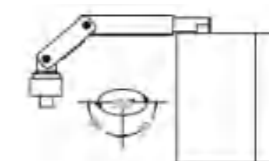
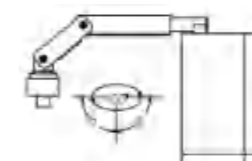
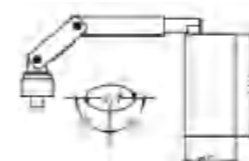
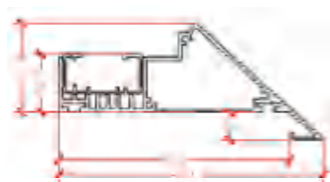
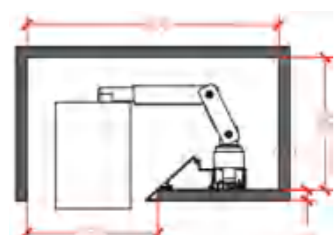
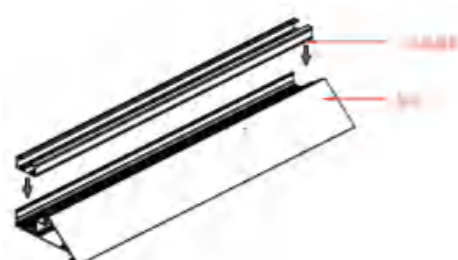
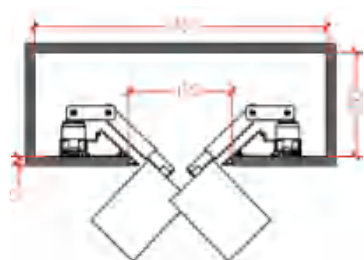

光学角度/Beam



芯片/Chip



可选反射器颜色/Reflector Colors





NMW-GD-54

NMW-GD-68

NMW-GD-85

功率 [Power]: 10W

功率 [Power]: 20W

功率 [Power]: 30W

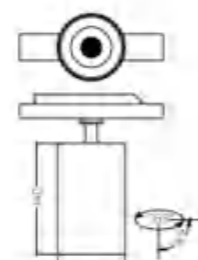
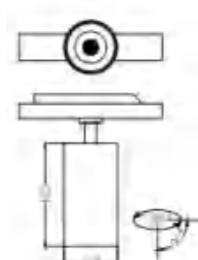
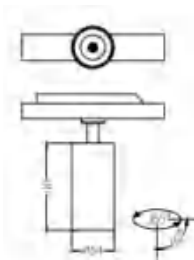

光学角度 Beam

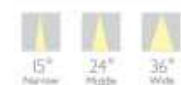

芯片/Chip



可选反射器颜色 Reflector Colors



NMW-WX-100

NMW-WX-170

功率 [Power]: 10W

功率 [Power]: 30W

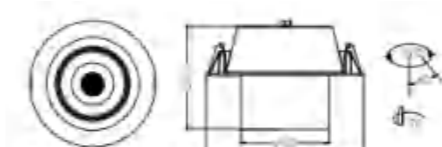
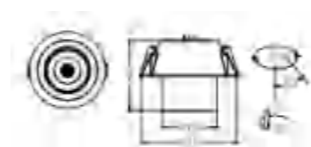

光学角度 Beam

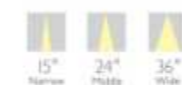

芯片/Chip



可选反射器颜色 Reflector Colors





NMW-TD-50

功率 [Power]: 5W

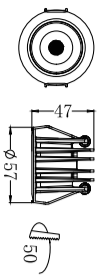

NMW-TD-60

功率 [Power]: 9W

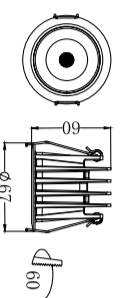

NMW-TD-75

功率 [Power]: 12W

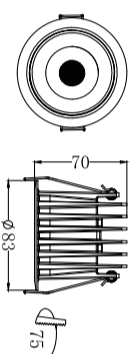

NMW-TD-90

功率 [Power]: 20W

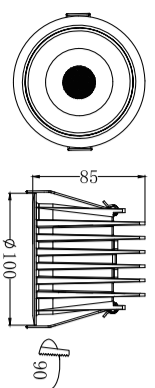

NMW-TD-120

功率 [Power]: 30W

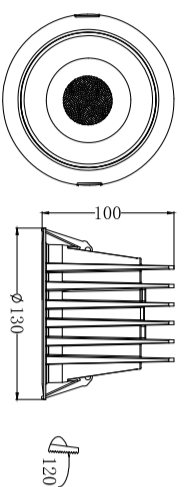

光学角度/Beam

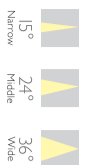

芯片/Chip



可选反射器颜色/Reflector Colors



NMW-TSD

NMW-TSD-60

功率 [Power]: 7W

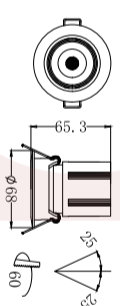

NMW-TSD-75

功率 [Power]: 12W

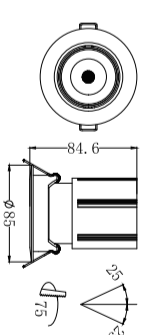

NMW-TSD-90

功率 [Power]: 20W

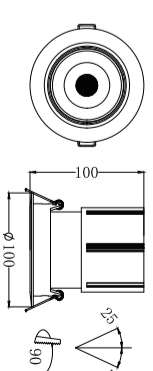

NMW-TSD-110

功率 [Power]: 30W
流明 [Lumen]: 2700lm

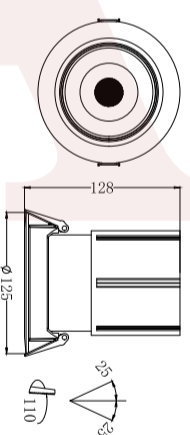

光学角度/Beam



芯片/Chip



可选反射器颜色/Reflector Colors





NMW-GSD-R75

功率 [Power]: 7W

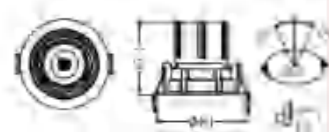

NMW-GSD-R90

功率 [Power] 12W



NMW-GSD-R105

功率 [Power] 20W

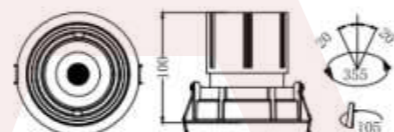

NMW-GSD-R120

功率 [Power] 30W

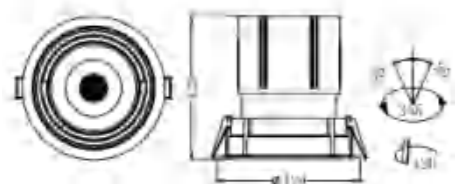

光学角度/Beam

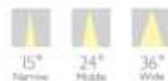

芯片/Chip



可选反射器颜色/Reflector Colors



NMW-GSD-S75

功率 [Power] 7W

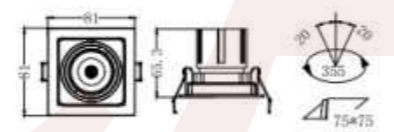

NMW-GSD-S90

功率 [Power]: 12W



NMW-GSD-S105

功率 [Power]: 20W



NMW-GSD-S120

功率 [Power] 30W

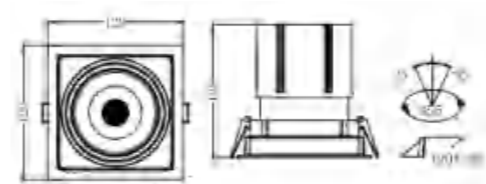

光学角度/Beam

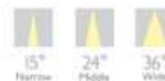

芯片/Chip



可选反射器颜色/Reflector Colors



LACAZ

每日/M 普斜89
sJolo)lopaaa/每塑器脂乡血

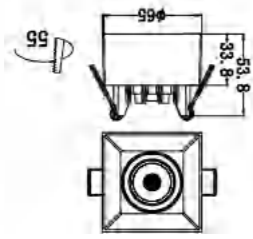

ML:[uaMOd] 率

SSS-MWN

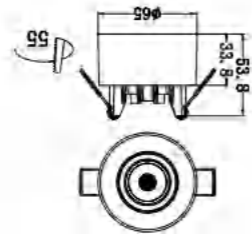

ML:[laMod]率竹

SSd-MWN

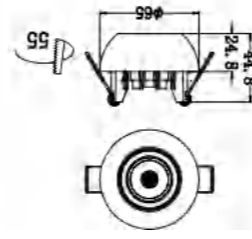

MaNOd)率

SSO-MWN

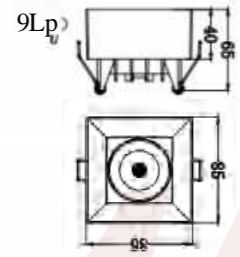

Ml [mod]率

S S-MWN

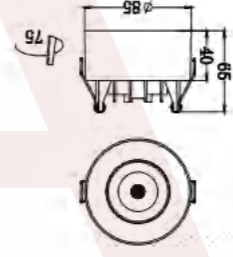

MOl:[laMod] 率竹

S d-MWN

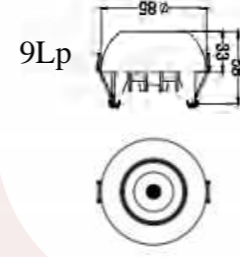

MZl:[laMOd] 率

S O-MWN



OS-MWN

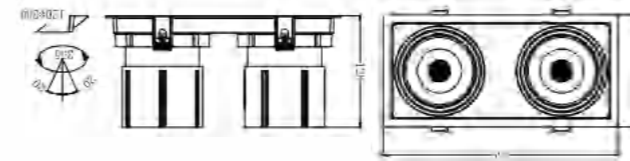

M0E*Z:[JaMOd] 率T

Z-0ZIS-OSD-MWN

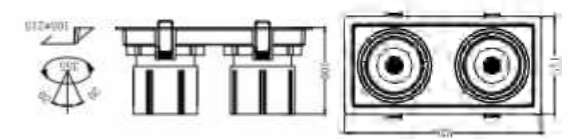

M0Z*Z:[aMOd]率

Z-SOIS-OSD-MWN

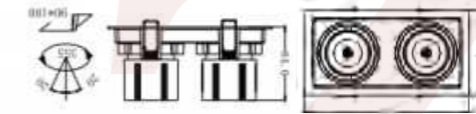

Mzl 2:[JaMOd] 率T

Z-06S-OSD-MWN

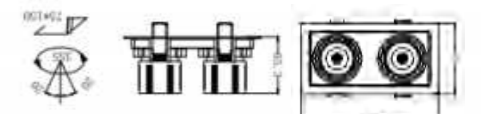

MLZ:[JaMod] 率工

Z-S S-OS9-MWN



OS-MWN

LACAZ



LACAZ



自由组合
多种造型
DIY你的空间

Combination Of
Magic
And Change

LACAZ



LACAZ



XTDR1-A-6



XTDR1-A-12



XTDR1-A-18



XTDR1-A-24



C-12



C-18



C-24



TD-12



TD-18



TD-24



SD-12



SD-18



SD-24



GD-12



GD-18



GD-24

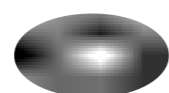

XTDR1-B-06



XTDR1-B-12



XTDR1-B-18



XTDRI-A-06

功率 [Power] : 8W
 色温 [CCT] : 3000K | 4000K | 5000K
 眩光值 [UGR] : <17
 显指 [CRI] : 90+
 材质 [Material] : Die casting aluminium
 颜色 [Color] : WH/BK

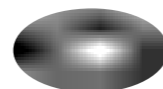
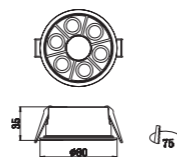

XTDRI-B-06

功率 [Power] : 8W
 色温 [CCT] : 3000K | 4000K | 5000K
 眩光值 [UGR] : <17
 显指 [CRI] : 90+
 材质 [Material] : Die casting aluminium
 颜色 [Color] : WH/BK

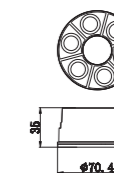

XTDRI-A-12

功率 [Power] : 15W
 色温 [CCT] : 3000K | 4000K | 5000K
 眩光值 [UGR] : <17
 显指 [CRI] : 90+
 材质 [Material] : Die casting aluminium
 颜色 [Color] : WH/BK

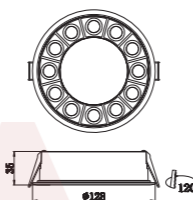

XTDRI-B-12

功率 [Power] : 15W
 色温 [CCT] : 3000K | 4000K | 5000K
 眩光值 [UGR] : <17
 显指 [CRI] : 90+
 材质 [Material] : Die casting aluminium
 颜色 [Color] : WH/BK

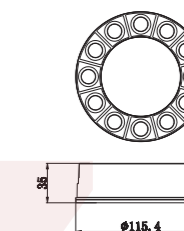

XTDRI-A-18

功率 [Power] : 20W
 色温 [CCT] : 3000K | 4000K | 5000K
 眩光值 [UGR] : <17
 显指 [CRI] : 90+
 材质 [Material] : Die casting aluminium
 颜色 [Color] : WH/BK

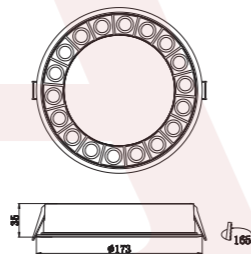

XTDRI-B-18

功率 [Power] : 20W
 色温 [CCT] : 3000K | 4000K | 5000K
 眩光值 [UGR] : <17
 显指 [CRI] : 90+
 材质 [Material] : Die casting aluminium
 颜色 [Color] : WH/BK

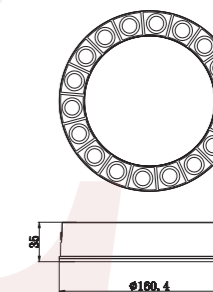

XTDRI-A-24

功率 [Power] : 30W
 色温 [CCT] : 3000K | 4000K | 5000K
 眩光值 [UGR] : <17
 显指 [CRI] : 90+
 材质 [Material] : Die casting aluminium
 颜色 [Color] : WH/BK

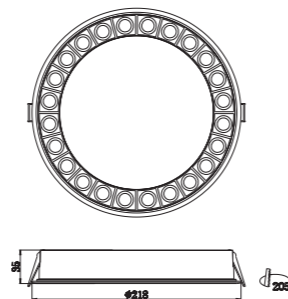

光学角度/Beam

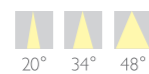

芯片/Chip



可选反光器颜色/Reflector Colors



光学角度/Beam

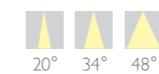

芯片/Chip

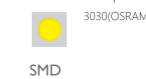

可选反光器颜色/Reflector Colors



XTDR2-A-06

功率 [Power] : 8W
 色温 [CCT] : 3000K | 4000K | 5000K
 眩光值 [UGR] : < 17
 显指 [CRI] : 90+
 材质 [Material] : Die casting aluminium
 颜色 [Color] : WH/BK

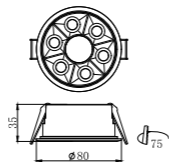

XTDR2-A-12

功率 [Power] : 15W
 色温 [CCT] : 3000K | 4000K | 5000K
 眩光值 [UGR] : < 17
 显指 [CRI] : 90+
 材质 [Material] : Die casting aluminium
 颜色 [Color] : WH/BK

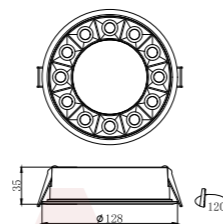

XTDR2-A-18

功率 [Power] : 20W
 色温 [CCT] : 3000K | 4000K | 5000K
 眩光值 [UGR] : < 17
 显指 [CRI] : 90+
 材质 [Material] : Die casting aluminium
 颜色 [Color] : WH/BK

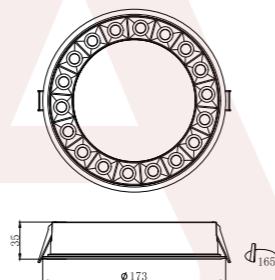

XTDR2-A-24

功率 [Power] : 30W
 色温 [CCT] : 3000K | 4000K | 5000K
 眩光值 [UGR] : < 17
 显指 [CRI] : 90+
 材质 [Material] : Die casting aluminium
 颜色 [Color] : WH/BK

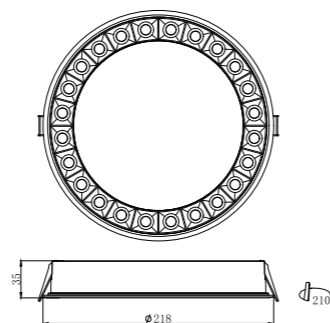

光学角度/Beam



芯片/Chip

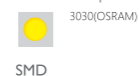

可选反光器颜色/Reflector Colors



XTDR2-B-06

功率 [Power] : 8W
 色温 [CCT] : 3000K | 4000K | 5000K
 眩光值 [UGR] : < 17
 显指 [CRI] : 90+
 材质 [Material] : Die casting aluminium
 颜色 [Color] : WH/BK

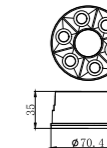

XTDR2-B-12

功率 [Power] : 15W
 色温 [CCT] : 3000K | 4000K | 5000K
 眩光值 [UGR] : < 17
 显指 [CRI] : 90+
 材质 [Material] : Die casting aluminium
 颜色 [Color] : WH/BK

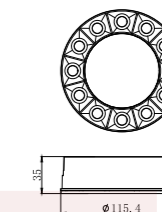

XTDR2-B-18

功率 [Power] : 20W
 色温 [CCT] : 3000K | 4000K | 5000K
 眩光值 [UGR] : < 17
 显指 [CRI] : 90+
 材质 [Material] : Die casting aluminium
 颜色 [Color] : WH/BK

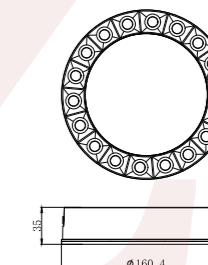

光学角度/Beam



芯片/Chip



可选反光器颜色/Reflector Colors



**GD-12**

功率 [Power] : 3W
 色温 [CCT] : 3000K | 4000K | 5000K
 眩光值 [UGR] : < 17
 显指 [CRI] : 90+
 材质 [Material] : Die casting aluminium
 颜色 [Color] : WH/BK

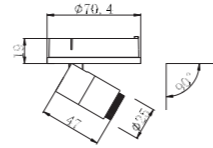
**GD-18**

功率 [Power] : 8W
 色温 [CCT] : 3000K | 4000K | 5000K
 眩光值 [UGR] : < 17
 显指 [CRI] : 90+
 材质 [Material] : Die casting aluminium
 颜色 [Color] : WH/BK

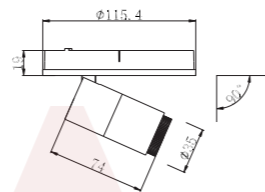
**GD-24**

功率 [Power] : 12W
 色温 [CCT] : 3000K | 4000K | 5000K
 眩光值 [UGR] : < 17
 显指 [CRI] : 90+
 材质 [Material] : Die casting aluminium
 颜色 [Color] : WH/BK

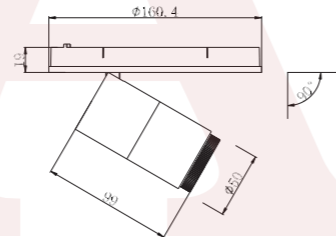

光学角度/Beam

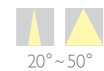

20° ~ 50°

芯片/Chip

3030
COB

SMD

**TD-12**

功率 [Power] : 7W
 色温 [CCT] : 3000K | 4000K | 5000K
 眩光值 [UGR] : UGR: < 17
 显指 [CRI] : 90+
 材质 [Material] : Die casting aluminium
 颜色 [Color] : WH/BK

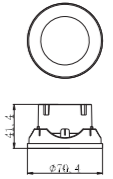
**TD-18**

功率 [Power] : 10W
 色温 [CCT] : 3000K | 4000K | 5000K
 眩光值 [UGR] : < 17
 显指 [CRI] : 90+
 材质 [Material] : Die casting aluminium
 颜色 [Color] : WH/BK

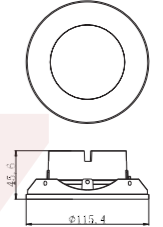
**TD-24**

功率 [Power] : 15W
 色温 [CCT] : 3000K | 4000K | 5000K
 眩光值 [UGR] : < 17
 显指 [CRI] : 90+
 材质 [Material] : Die casting aluminium
 颜色 [Color] : WH/BK

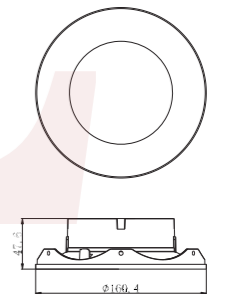

光学角度/Beam



120°

芯片/Chip

3030
COB

SMD

LACAZ



SD-12

功率 [Power]: 7W
 色温 [CCT]: 3000K | 4000K | 5000K | 6000K
 遮光角 [Shielding angle]: 31.8°
 眩光值 [UGR]: < 17
 显指 [CRI]: 90+
 材质 [Material]: Die casting aluminium
 颜色 [Color]: WH/BK

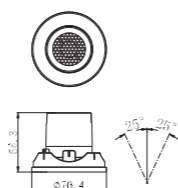

SD-18

功率 [Power]: 12W
 色温 [CCT]: 3000K | 4000K | 5000K | 6000K
 遮光角 [Shielding angle]: 31.8°
 眩光值 [UGR]: < 17
 显指 [CRI]: 90+
 材质 [Material]: Die casting aluminium
 颜色 [Color]: WH/BK

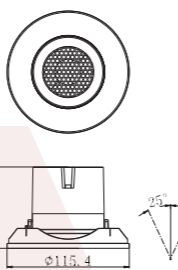

SD-24

功率 [Power]: 20W
 色温 [CCT]: 3000K | 4000K | 5000K | 6000K
 遮光角 [Shielding angle]: 31.8°
 眩光值 [UGR]: < 17
 显指 [CRI]: 90+
 材质 [Material]: Die casting aluminium
 颜色 [Color]: WH/BK

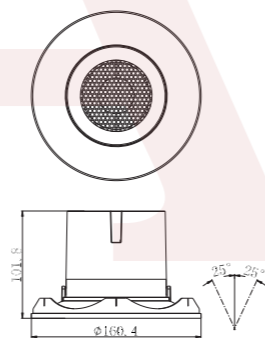

光学角度/Beam

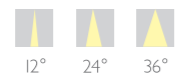

芯片/Chip



MD009-12

功率 [Power] : 15W
 色温 [CCT] : 3000K | 4000K | 5000K
 眩光值 [UGR] : < 17
 显指 [CRI] : 90+
 材质 [Material] : Die casting aluminium
 颜色 [Color] : WH/BK

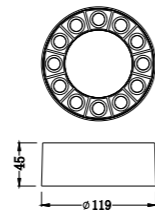

MD009-18

功率 [Power] : 20W
 色温 [CCT] : 3000K | 4000K | 5000K
 眩光值 [UGR] : < 17
 显指 [CRI] : 90+
 材质 [Material] : Die casting aluminium
 颜色 [Color] : WH/BK

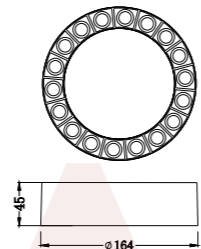

MD009-24

功率 [Power] : 30W
 色温 [CCT] : 3000K | 4000K | 5000K
 眩光值 [UGR] : < 17
 显指 [CRI] : 90+
 材质 [Material] : Die casting aluminium
 颜色 [Color] : WH/BK

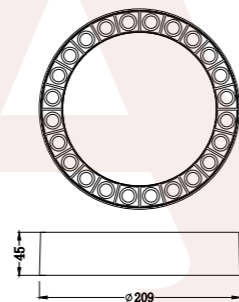

MD010-12

功率 [Power] : 15W
 色温 [CCT] : 3000K | 4000K | 5000K
 眩光值 [UGR] : < 17
 显指 [CRI] : 90+
 材质 [Material] : Die casting aluminium
 颜色 [Color] : WH/BK

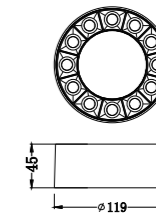

MD010-18

功率 [Power] : 20W
 色温 [CCT] : 3000K | 4000K | 5000K
 眩光值 [UGR] : < 17
 显指 [CRI] : 90+
 材质 [Material] : Die casting aluminium
 颜色 [Color] : WH/BK

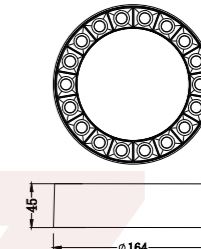

MD010-24

功率 [Power] : 30W
 色温 [CCT] : 3000K | 4000K | 5000K
 眩光值 [UGR] : < 17
 显指 [CRI] : 90+
 材质 [Material] : Die casting aluminium
 颜色 [Color] : WH/BK

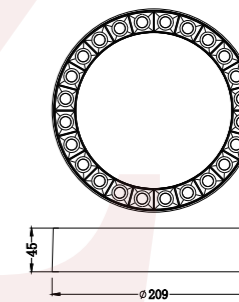

光学角度/Beam



芯片/Chip

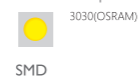

可选反光器颜色/Reflector Colors



光学角度/Beam



芯片/Chip

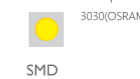

可选反光器颜色/Reflector Colors





LINEAR

Light

线条灯系列

XTD9-03

尺寸 [Size] : 95x45x49.5mm
 开孔尺寸 [Cut Hole] : 87x37mm
 功率 [Power] : 8W
 材质 [Material] : Die casting aluminium

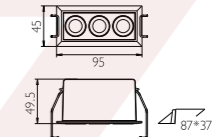

XTD9-06

尺寸 [Size] : 174x45x49.5mm
 开孔尺寸 [Cut Hole] : 165x37mm
 功率 [Power] : 15W
 材质 [Material] : Die casting aluminium

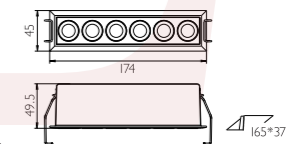

XTD9-12

尺寸 [Size] : 333x45x49.5mm
 开孔尺寸 [Cut Hole] : 325x37mm
 功率 [Power] : 24W
 材质 [Material] : Die casting aluminium

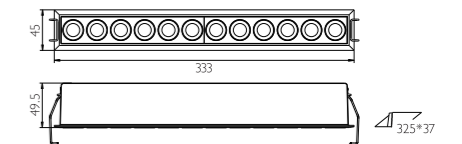

可选光学角度/Beam

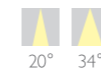

芯片/Chip

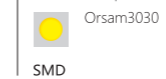

LINEAR

LACAZ

AW-XTD-AI

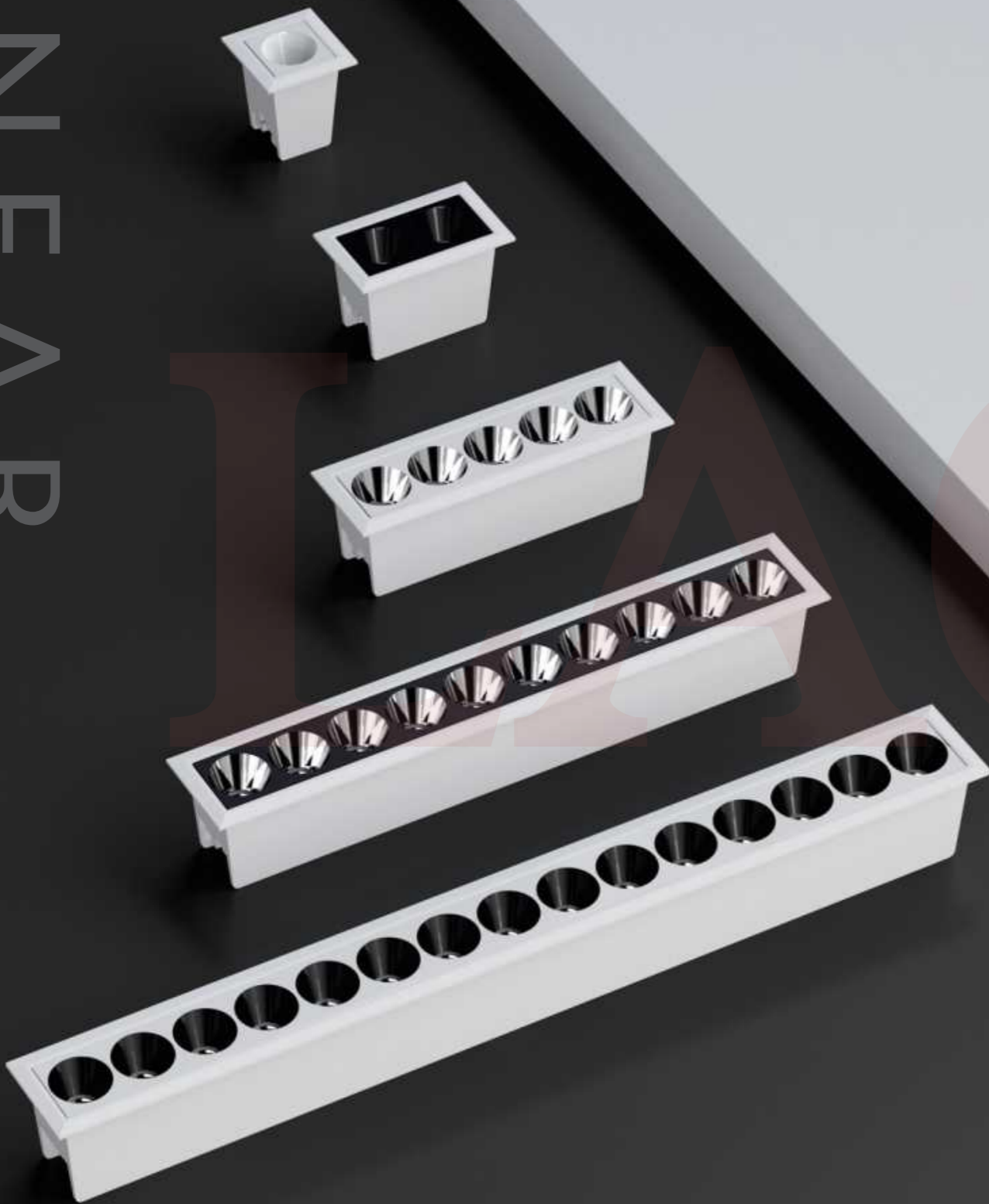

1 LED | 3W

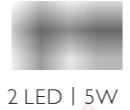

2 LED | 5W

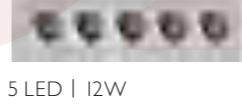

5 LED | 12W



10 LED | 20W



15 LED | 30W

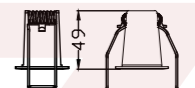

37*37
AW-XTD-AI-01

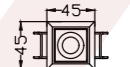

68*37
AW-XTD-AI-02

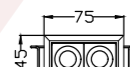

140*37
AW-XTD-AI-05

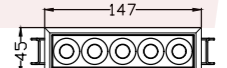

273*37
AW-XTD-AI-10

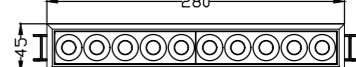

405*37
AW-XTD-AI-15

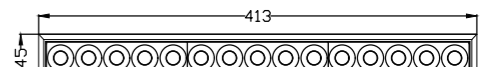

光学角度/Beam

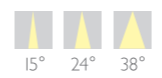

芯片/Chip

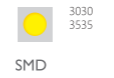

可选反射器颜色/Available Colors



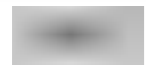

3 LED | 4W | 280lm
3000K | 4000K | 5000K | 6000K
UGR<17 | CRI 90+
Die casting aluminium



6 LED | 8W | 560lm
3000K | 4000K | 5000K | 6000K
UGR<17 | CRI 90+
Die casting aluminium



12 LED | 15W | 1050lm
3000K | 4000K | 5000K | 6000K
UGR<17 | CRI 90+
Die casting aluminium



4 LED | 5W | 350lm
3000K | 4000K | 5000K | 6000K
UGR<17 | CRI 90+
Die casting aluminium



9 LED | 10W | 700lm
3000K | 4000K | 5000K | 6000K
UGR<17 | CRI 90+
Die casting aluminium



16 LED | 15W | 1050lm
3000K | 4000K | 5000K | 6000K
UGR<17 | CRI 90+
Die casting aluminium



25 LED | 20W | 1400lm
3000K | 4000K | 5000K | 6000K
UGR<17 | CRI 90+
Die casting aluminium

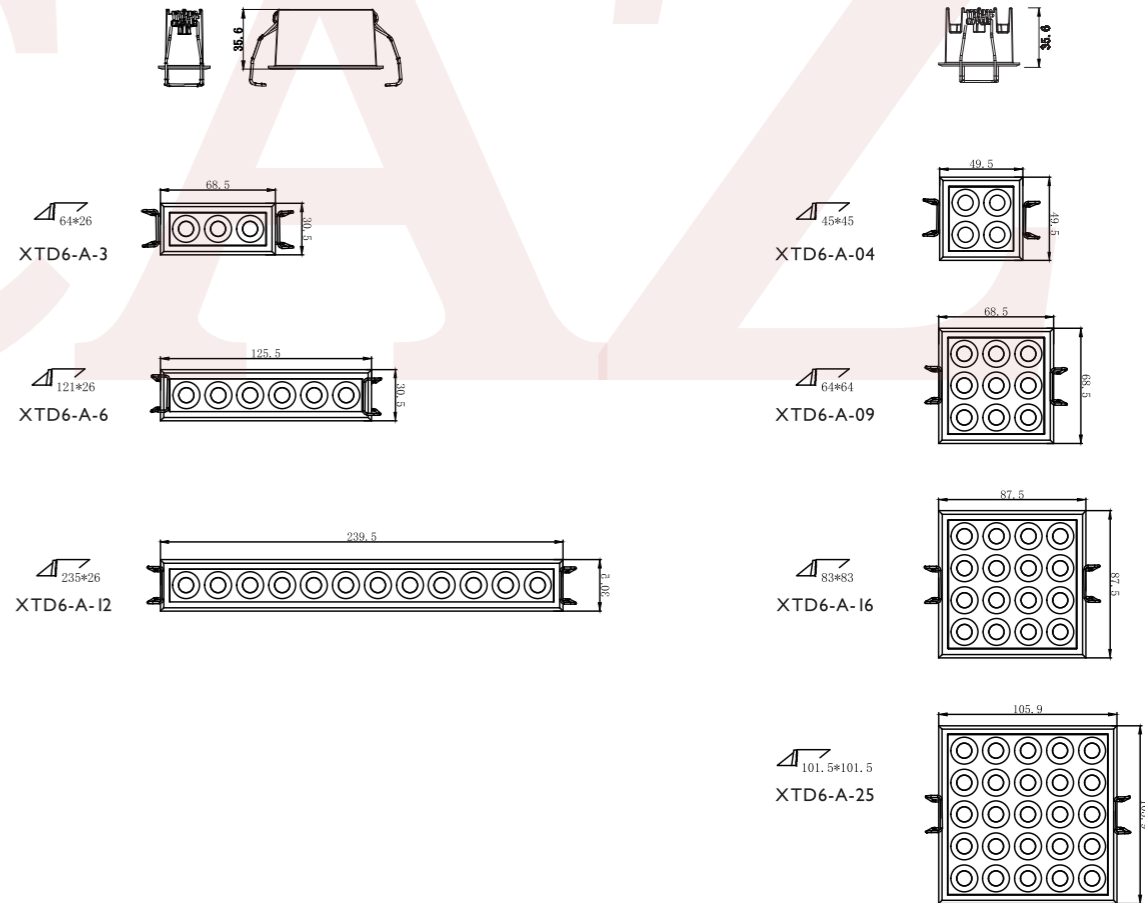
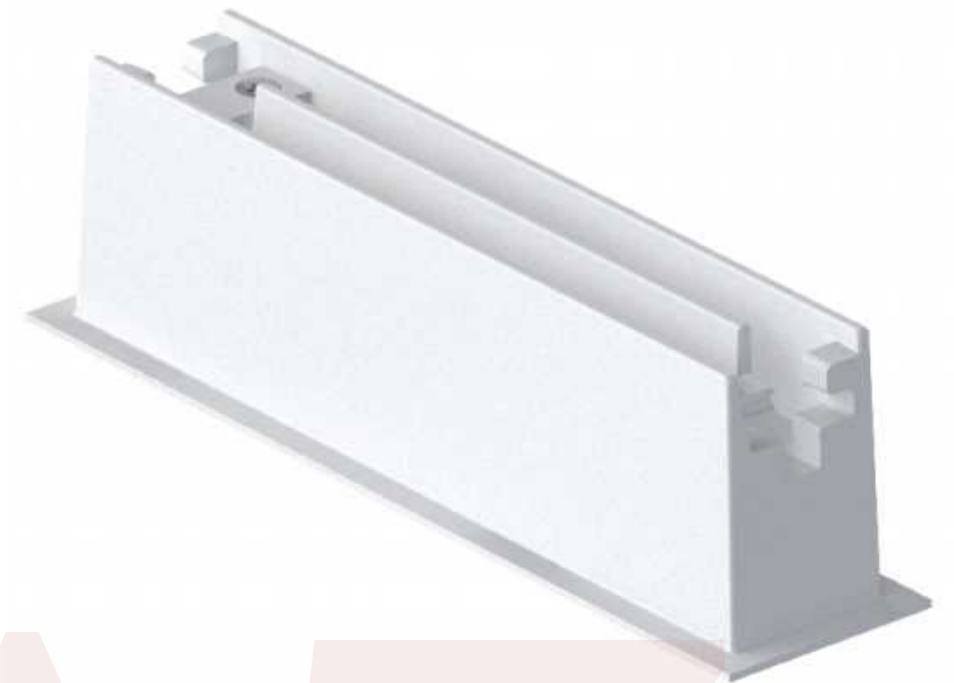

光学角度/Beam

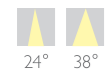

芯片/Chip



可选反射器颜色/Available Colors



LACAZ



1 LED | 1W

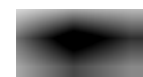

2 LED | 5W



3 LED | 8W



4 LED | 10W



5 LED | 12W



9 LED | 18W

光学角度/Beam



24°

芯片/Chip



SMD

XTD8-01

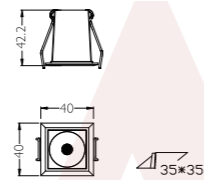

XTD8-02

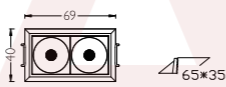

XTD8-03

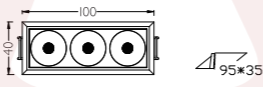

XTD8-04

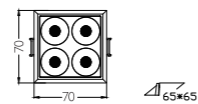

XTD8-05

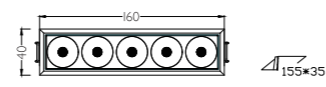

XTD8-09

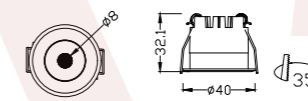
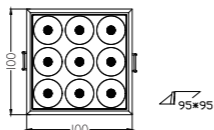

TSD010-35
功率 [Power]: 2.5W
材质 [Material]: Die-cast aluminum
开孔 [Cut Hole]: Φ35mm

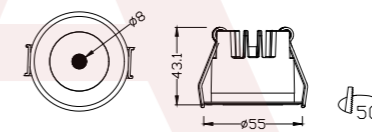

TSD010-50
功率 [Power]: 4W
材质 [Material]: Die-cast aluminum
开孔 [Cut Hole]: Φ50mm

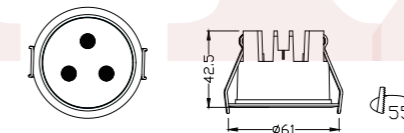

TSD010-55
功率 [Power]: 8W
材质 [Material]: Die-cast aluminum
开孔 [Cut Hole]: Φ55mm

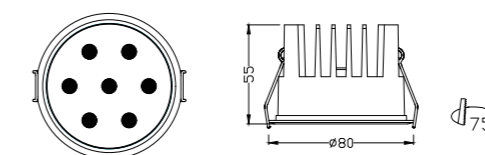

TSD010-75
功率 [Power]: 15W
材质 [Material]: Die-cast aluminum
开孔 [Cut Hole]: Φ75mm

光学角度/Beam



24°



LACAZ



1 LED | 3W



3 LED | 6W

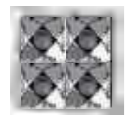

4 LED | 10W



5 LED | 12W



9 LED | 18W



10 LED | 24W



1 LED | 3W



3 LED | 6W



4 LED | 10W



5 LED | 12W



9 LED | 18W



10 LED | 24W



1 LED | 3W



3 LED | 6W



4 LED | 10W



5 LED | 12W

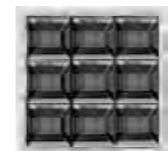

9 LED | 18W



10 LED | 24W



1 LED | 3W



3 LED | 6W



4 LED | 10W



5 LED | 12W



9 LED | 18W



10 LED | 24W

光学角度/Beam

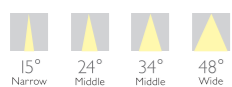

芯片/Chip



光学角度/Beam



芯片/Chip



光学角度/Beam



芯片/Chip



光学角度/Beam



芯片/Chip



LACAZ



1 LED | 3W



3 LED | 6W



4 LED | 10W



5 LED | 12W



9 LED | 18W



10 LED | 24W



1 LED | 3W

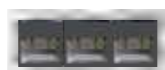

3 LED | 6W



4 LED | 10W



5 LED | 12W



9 LED | 18W



10 LED | 24W

光学角度/Beam



Flood 40°

芯片/Chip



SMD

料号 (CREE/XP系列)
XP-L
XP-H35
XP-G2.3
XP-E2

光学角度/Beam



Wallwasher

芯片/Chip



SMD

料号 (CREE/XP系列)
XP-L
XP-H35
XP-G2.3
XP-E2

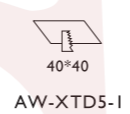

40*40
AW-XTD5-1

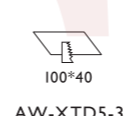

100*40
AW-XTD5-3

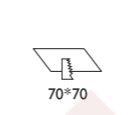

70*70
AW-XTD5-4



160*40
AW-XTD5-5

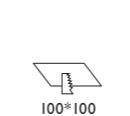

100*100
AW-XTD5-9



310*40
AW-XTD5-10

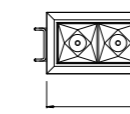
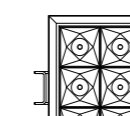
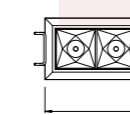
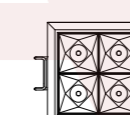
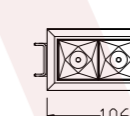
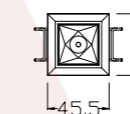
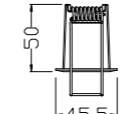
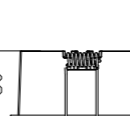
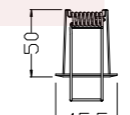
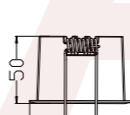
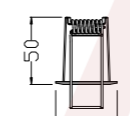
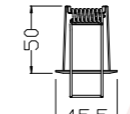

LACAZ

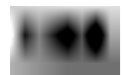

2 LED | 3W



2 LED | 3W

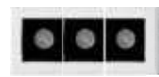

3 LED | 5W

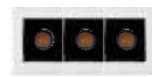

3 LED | 5W



4 LED | 7W



4 LED | 7W

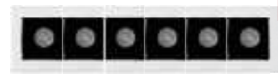

6 LED | 8W



6 LED | 8W

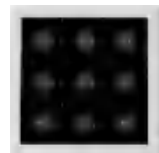

9 LED | 12W

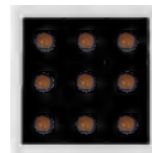

9 LED | 12W

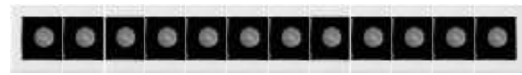

12 LED | 20W

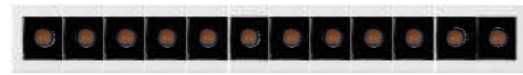

12 LED | 20W

光学角度/Beam

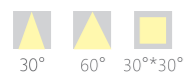

芯片/Chip



SMD

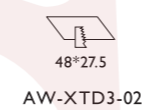

48*27.5
AW-XTD3-02

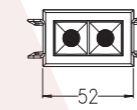
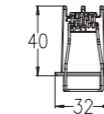

57*27.5
AW-XTD3-03

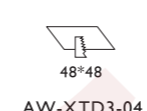
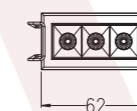
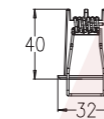

48*48
AW-XTD3-04

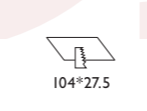
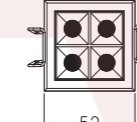
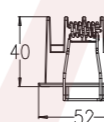

104*27.5
AW-XTD3-05

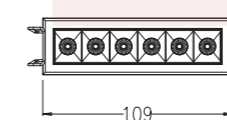
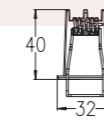

68*68
AW-XTD3-09

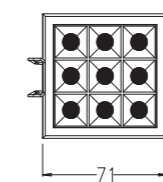
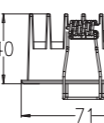

200*27.5
AW-XTD3-12

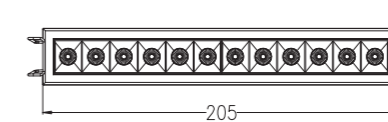
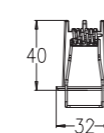

LACAZ



1 LED | 5W



3 LED | 12W

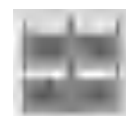

4 LED | 15W



5 LED | 20W

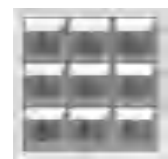

9 LED | 36W



10 LED | 40W



1 LED | 5W



3 LED | 12W



4 LED | 15W



5 LED | 20W



9 LED | 36W



10 LED | 40W

光学角度/Beam

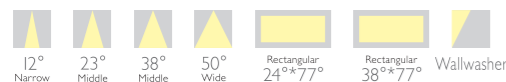

芯片/Chip



AW-XTD2-01

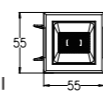

AW-XTD2-03

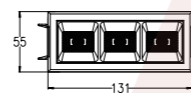

AW-XTD2-04

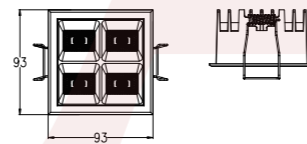

AW-XTD2-05

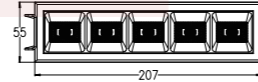

AW-XTD2-09

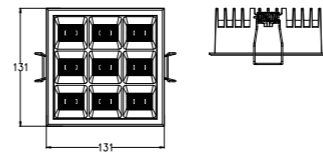

AW-XTD2-10

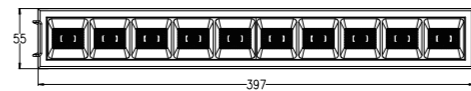

LACAZ



4 LED | 15W



4 LED | 15W



AW-MD006-4

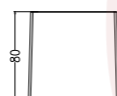

9 LED | 36W



9 LED | 36W

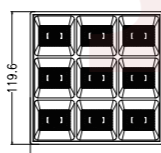

AW-MD006-9



光学角度/Beam

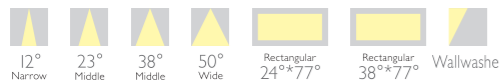

芯片/Chip





Trimless

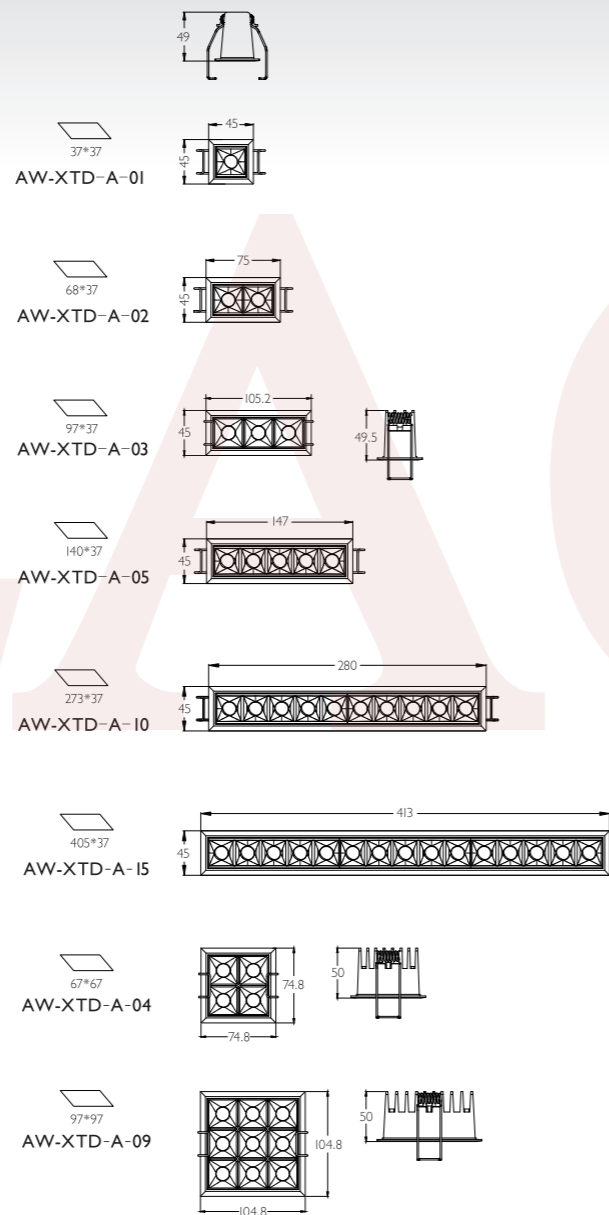

LIGHT EFFECT



光学角度/Beam

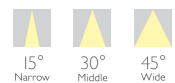

芯片/Chip

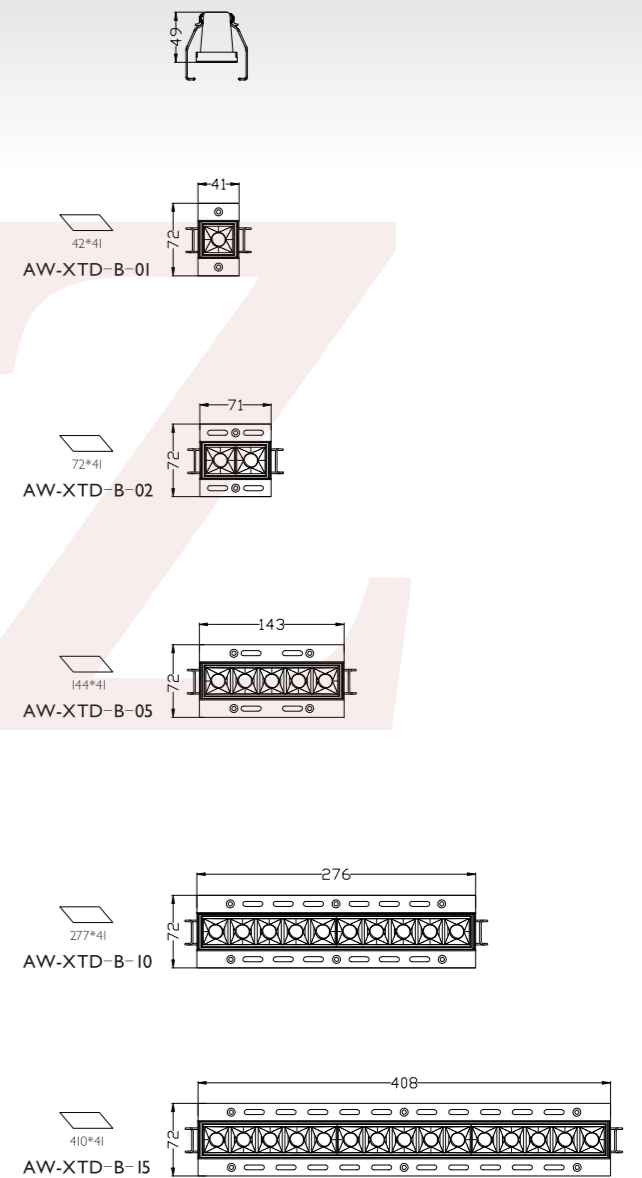

光学角度/Beam

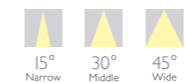

芯片/Chip





5 LED | 10W

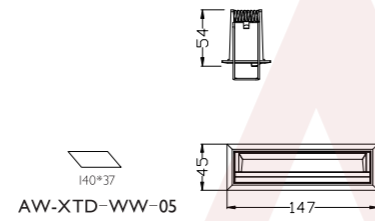

AW-XTD-WW-05



10 LED | 20W

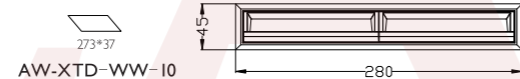

AW-XTD-WW-10



15 LED | 30W

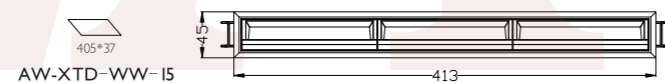

AW-XTD-WW-15



10 LED | 10W

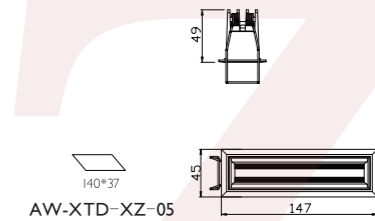

AW-XTD-XZ-05



20 LED | 20W

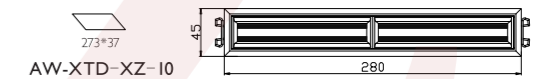

AW-XTD-XZ-10



30 LED | 30W

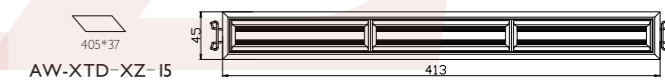

AW-XTD-XZ-15

光学角度/Beam



Wallwasher

芯片/Chip



SMD



Wall washing Lighting

光学角度/Beam

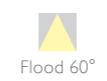

Flood 60°

芯片/Chip



SMD



10 LED | 20W

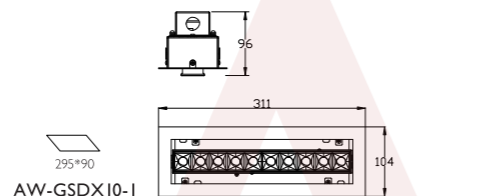

15 LED | 30W



10×2 LED | 40W

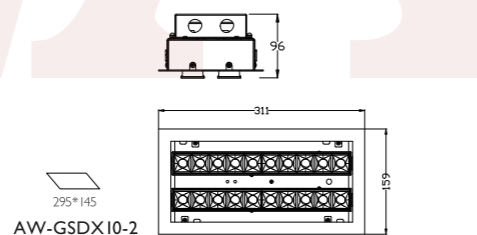

15×2 LED | 60W

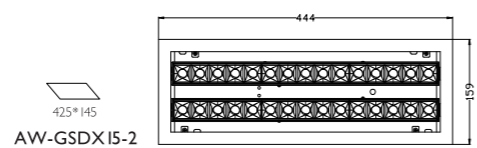

10 LED | 10W

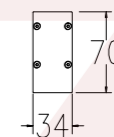

20 LED | 20W

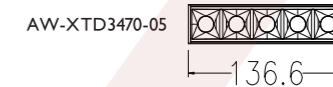

30 LED | 30W

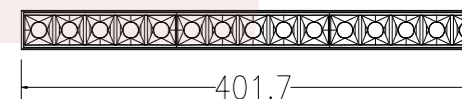
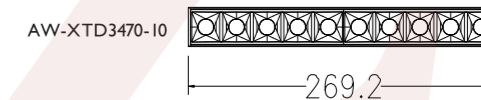

光学角度/Beam



芯片/Chip



SMD



光学角度/Beam

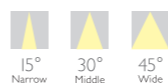

芯片/Chip



SMD



1 LED | 10W



2 LED | 20W



3 LED | 30W

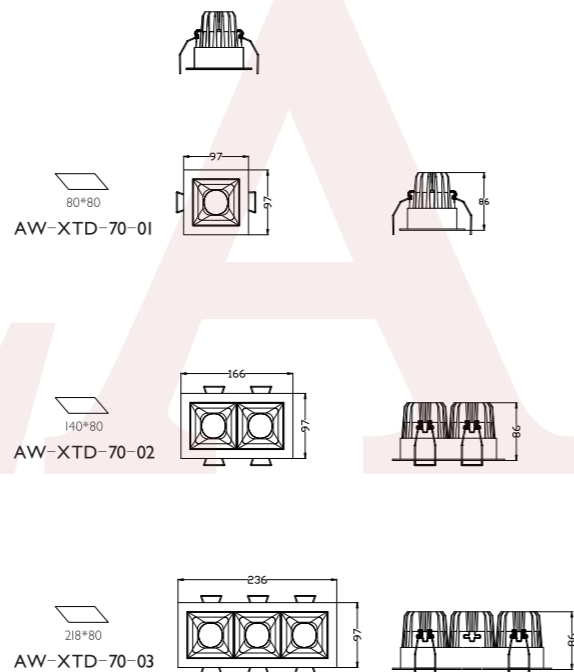

光学角度/Beam

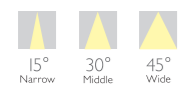

芯片/Chip



COB

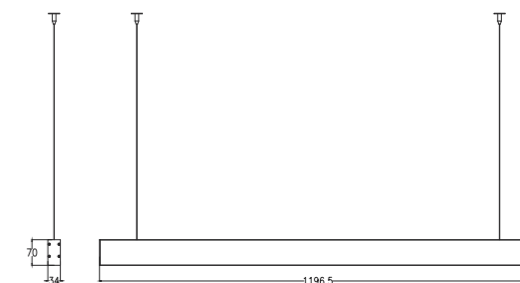

AW-XTD3470-1200A 30W

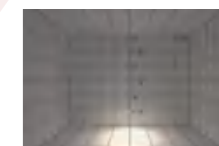

AW-XTD3470-1200B 40W

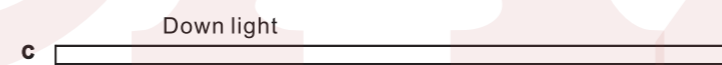

AW-XTD3470-1200C 40W

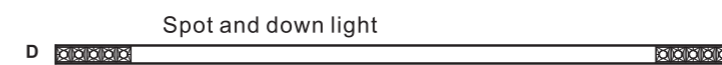

AW-XTD3470-1200D 40W

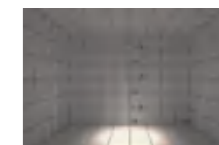

AW-XTD3470-1200E 40W

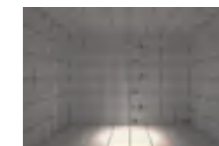

光学角度/Beam

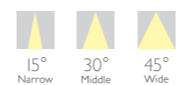

芯片/Chip



SMD

MINI SPOT

Light

迷你天花射灯系列

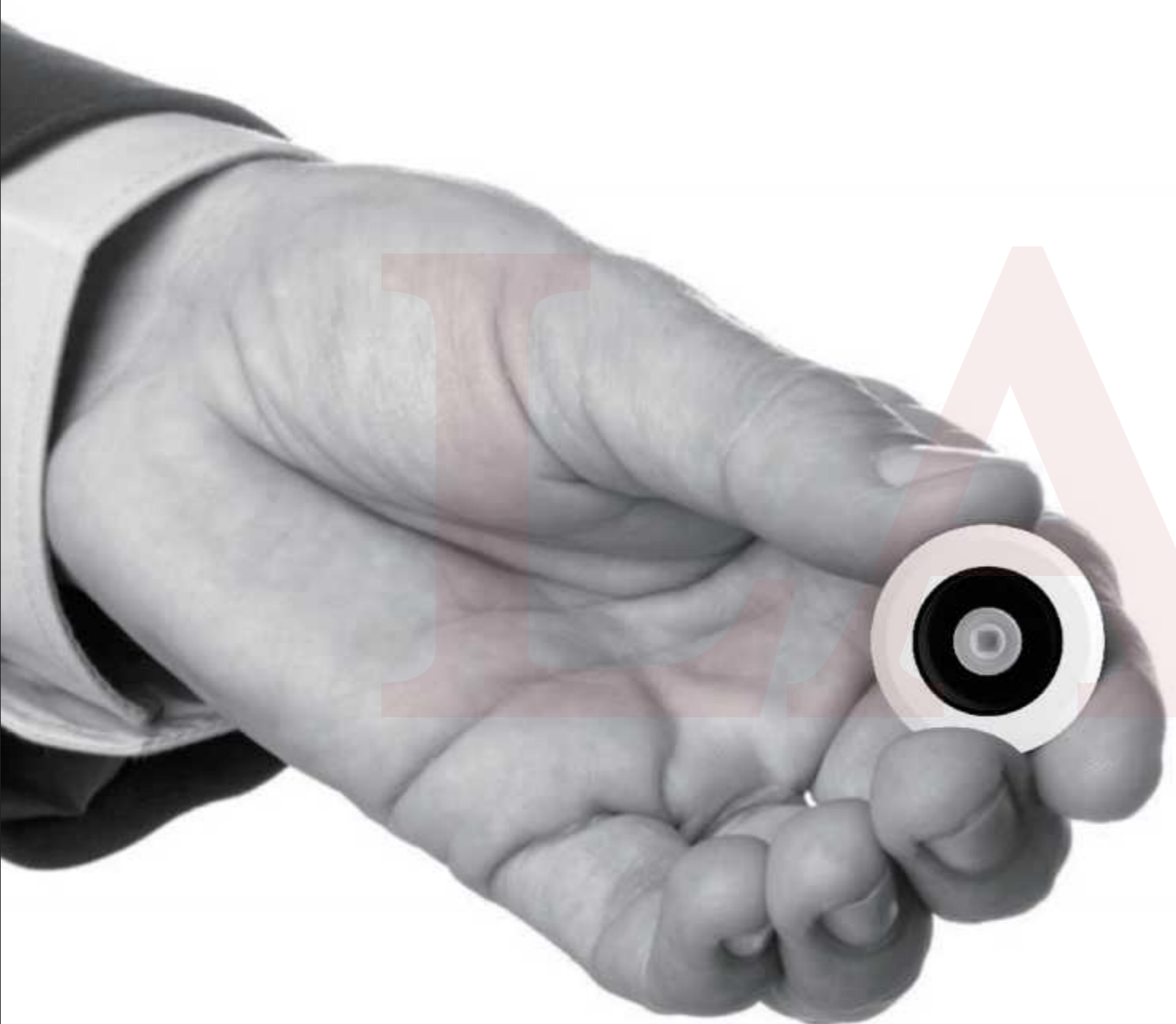

任意造形
随心所欲

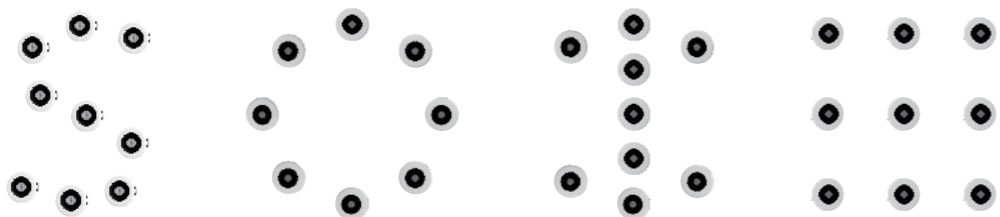

LACAZ

TSD009



TSD009-25

功率 [Power]: 1.5W
角度 [Beam]: 15°、27°、60°
芯片 [Chip]: OSRAM 3030
材质 [Material]: Die-cast aluminum
开孔 [Cut Hole]: Φ 26mm



TSD009-35

功率 [Power]: 2.5W
角度 [Beam]: 15°、25°、50°
芯片 [Chip]: OSRAM 3030
材质 [Material]: Die-cast aluminum
开孔 [Cut Hole]: Φ 35mm

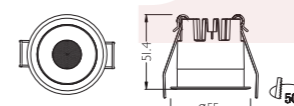

TSD009-50

功率 [Power]: 4W
角度 [Beam]: 15°、25°、45°
芯片 [Chip]: OSRAM 3030
材质 [Material]: Die-cast aluminum
开孔 [Cut Hole]: Φ 50mm

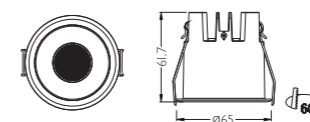

TSD009-60

功率 [Power]: 8W
角度 [Beam]: 20°、40°
芯片 [Chip]: COB CREE 1304
材质 [Material]: Die-cast aluminum
开孔 [Cut Hole]: Φ 60mm

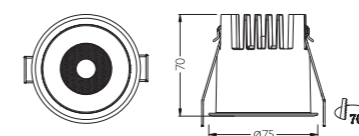

TSD009-70

功率 [Power]: 12W
角度 [Beam]: 15°、24°、36°
芯片 [Chip]: COB CREE 1507
材质 [Material]: Die-cast aluminum
开孔 [Cut Hole]: Φ 70mm





LACAZ

HTSD2



HTSD2-55

功率 [Power]: 5W

HTSD2-75

功率 [Power]: 9W

HTSD2-95

功率 [Power]: 15W

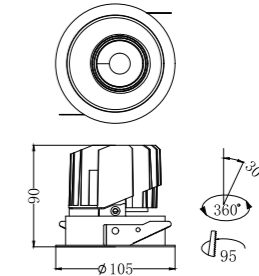
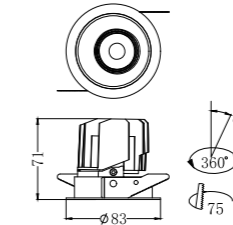
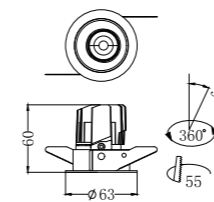

光学角度/Beam

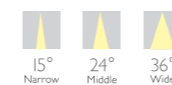

芯片/Chip



IP54

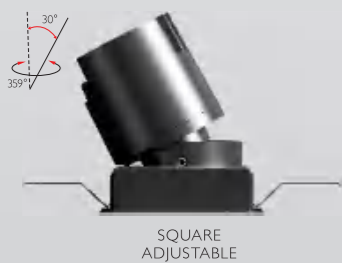

SQUARE ADJUSTABLE

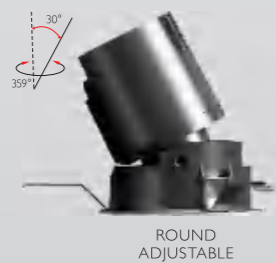

ROUND ADJUSTABLE



SQUARE FIXED

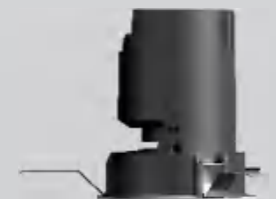

ROUND FIXED

LACAZ



Rond



Square



Fixed/下照



Adjustable/可调



Wallwasher/洗墙

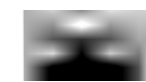

Fixed/下照

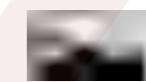

Adjustable/可调



Wallwasher/洗墙

Available Colors/可选反射器颜色



CH/铬色



GD/金色



SL/银色



BK/黑色



WH/白色



可调(Adjustable) 					
					
HTSD-A-R60	HTSD-A-R80	HTSD-A-R100	HTSD-A-S60	HTSD-A-S80	HTSD-A-S100
					
					
					
7W	12W	20W	7W	12W	20W
 18° Narrow  24° Middle  36° Wide			 COB 科锐 (CREE) 欧司朗 (OSRAM) 晶明 (Lumileds)		
 CH/铬色  GD/金色  SL/银色  BK/黑色  WH/白色					
 Accessories/配件					



HTSD-F-S HTSD-A-S HTSD-FW-S



HTSD-F-R HTSD-A-R HTSD-FW-R

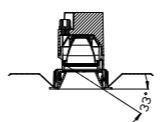



Ø50



FOUNDATION

Fixed downlight

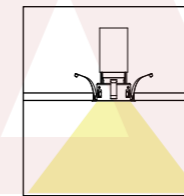

SD50A 5W



SD50A 8W



SD50A 12W

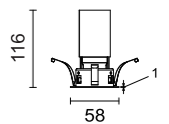
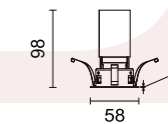
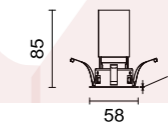

PICK UP

Adjustable downlight

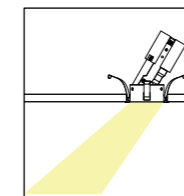

SD50B 5W



SD50B 8W

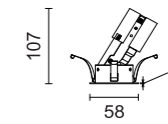
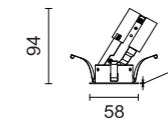

光学角度/Beam

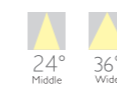

芯片/Chip



ACCESSORIES



SPOT

Light

天花射灯系列

LACAZ

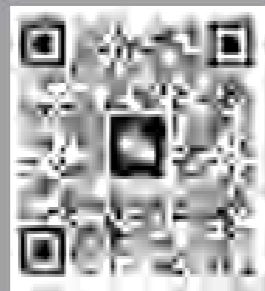

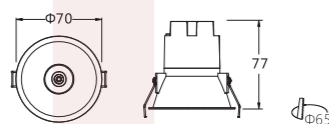

TSD002-2F
 功率 [Power] : 5W
 材质 [Material] : Die-cast aluminum+PC
 开孔 [Cut Hole] : $\Phi 65$ mm

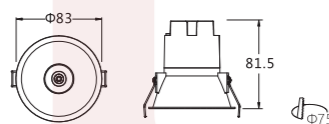

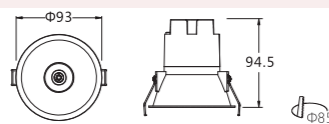

TSD002-2.5F
 功率 [Power] : 5W
 材质 [Material] : Die-cast aluminum+PC
 开孔 [Cut Hole] : $\Phi 75$ mm

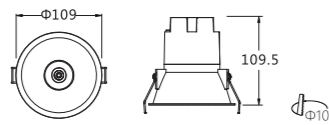

TSD002-3F
 功率 [Power] : 10W
 材质 [Material] : Die-cast aluminum+PC
 开孔 [Cut Hole] : $\Phi 85$ mm



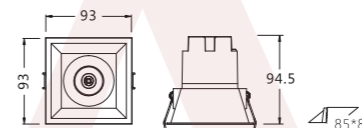
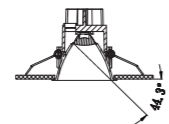

TSD002-3.5F
 功率 [Power] : 10W
 材质 [Material] : Die-cast aluminum+PC
 开孔 [Cut Hole] : $\Phi 100$ mm

光学角度/Beam | 芯片/Chip



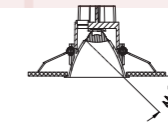

TSD003-3F
 功率 [Power] : 10W
 材质 [Material] : Die-cast aluminum+PC
 开孔 [Cut Hole] : 85*85mm

光学角度/Beam | 芯片/Chip



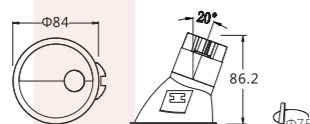

LACAZ

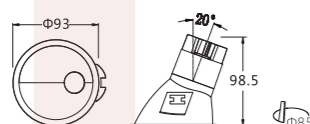

TSD002X-2F
 功率 [Power] : 5W
 材质 [Material] : Die-cast aluminum+PC
 开孔 [Cut Hole] : $\Phi 75$ mm



TSD002X-3F
 功率 [Power] : 5W
 材质 [Material] : Die-cast aluminum+PC
 开孔 [Cut Hole] : $\Phi 85$ mm

光学角度/Beam

15° Narrow 24° Middle 38° Wide

芯片/Chip

科锐 (CREE)
西铁城 (CITIZEN)
COB

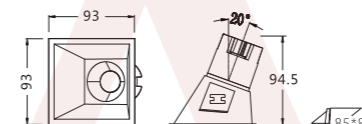
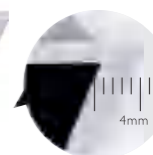

TSD003X-3F
 功率 [Power] : 5W
 材质 [Material] : Die-cast aluminum+PC
 开孔 [Cut Hole] : 85*85mm

光学角度/Beam

15° Narrow 24° Middle 38° Wide

芯片/Chip

科锐 (CREE)
西铁城 (CITIZEN)
COB



IP54



AW-TD059-3F

功率 [Power] : 10W
开孔 [Cutout] : $\Phi 90$ mm
灯体 [Size] : $\Phi 100 \times H 75$ mm



AW-TD059-4F

功率 [Power] : 20W
开孔 [Cutout] : $\Phi 130$ mm
灯体 [Size] : $\Phi 140 \times H 90$ mm



AW-TD059-6F

功率 [Power] : 30W
开孔 [Cutout] : $\Phi 170$ mm
灯体 [Size] : $\Phi 185 \times H 112$ mm

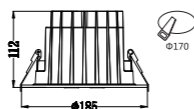

AW-TD059-8F

功率 [Power] : 40W
开孔 [Cutout] : $\Phi 200$ mm
灯体 [Size] : $\Phi 230 \times H 128$ mm

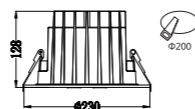

参数/Parameter

色温 [Color temp.] : 2700K | 3000K | 4000K | 5000K
材质 [Material] : Die-Cast Aluminum+PC
环境温度 [Temp.] : $-20^{\circ}\text{C} \sim +50^{\circ}\text{C}$
灯体颜色 [Body color] : WH

光学角度/Beam

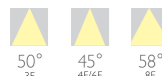

芯片/Chip



反光杯颜色/Reflector



IP54



AW-MD005-3F

功率 [Power] : 10W
灯体 [Size] : $\Phi 82 \times H 106$ mm



AW-MD005-4F

功率 [Power] : 20W
灯体 [Size] : $\Phi 115 \times H 120$ mm

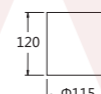

AW-MD005-6F

功率 [Power] : 30W
灯体 [Size] : $\Phi 149 \times H 143$ mm

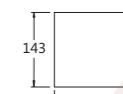

AW-MD005-8F

功率 [Power] : 40W
灯体 [Size] : $\Phi 187.5 \times H 159$ mm

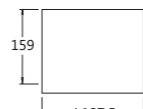

参数/Parameter

色温 [Color temp.] : 2700K | 3000K | 4000K | 5000K
材质 [Material] : Die-Cast Aluminum+PC
环境温度 [Temp.] : $-20^{\circ}\text{C} \sim +50^{\circ}\text{C}$
灯体颜色 [Body color] : WH | BK

光学角度/Beam

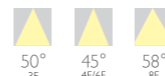

芯片/Chip



反光杯颜色/Reflector





A款/Trim



B款/Trim



A款/Trim



B款/Trim

AW-TD052-2.5F

功率 [Power] : 5W
开孔 [Cutout] : $\Phi 75$ mm
灯体 [Size] : $\Phi 90 \times H 56$ mm

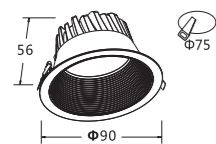

AW-TD052-3F

功率 [Power] : 9W
开孔 [Cutout] : $\Phi 90$ mm
灯体 [Size] : $\Phi 110 \times H 68$ mm

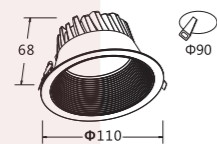

AW-TD052-4F

功率 [Power] : 15W
开孔 [Cutout] : $\Phi 120$ mm
灯体 [Size] : $\Phi 137.5 \times H 82$ mm

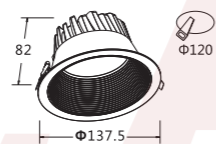

AW-TD052-5F

功率 [Power] : 20W
开孔 [Cutout] : $\Phi 140$ mm
灯体 [Size] : $\Phi 165 \times H 91$ mm

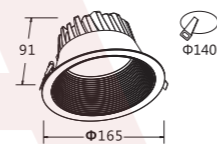

AW-TD052-6F

功率 [Power] : 30W
开孔 [Cutout] : $\Phi 170$ mm
灯体 [Size] : $\Phi 195 \times H 107$ mm

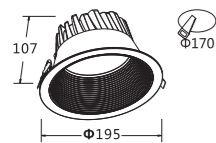

AW-TD052-8F

功率 [Power] : 40W
开孔 [Cutout] : $\Phi 200$ mm
灯体 [Size] : $\Phi 235 \times H 127.5$ mm

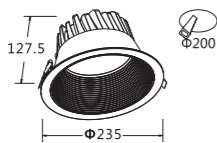

参数/Parameter

色温 [Color temp.] : 2700K | 3000K | 4000K | 5000K
材质 [Material] : Die-Cast Aluminum
环境温度 [Temp.] : $-20^{\circ}\text{C} \sim +50^{\circ}\text{C}$
灯体颜色 [Body color] : WH

芯片/Chip



SMD

AW-TD051-2.5F

功率 [Power] : 5W
开孔 [Cutout] : $\Phi 75$ mm
灯体 [Size] : $\Phi 90 \times H 56$ mm

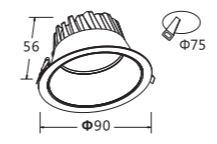

AW-TD051-3F

功率 [Power] : 9W
开孔 [Cutout] : $\Phi 90$ mm
灯体 [Size] : $\Phi 110 \times H 68$ mm

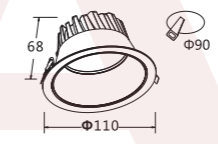

AW-TD051-4F

功率 [Power] : 15W
开孔 [Cutout] : $\Phi 120$ mm
灯体 [Size] : $\Phi 137.5 \times H 82$ mm

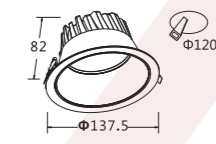

AW-TD051-5F

功率 [Power] : 20W
开孔 [Cutout] : $\Phi 140$ mm
灯体 [Size] : $\Phi 165 \times H 91$ mm

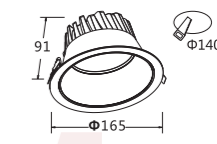

AW-TD051-6F

功率 [Power] : 30W
开孔 [Cutout] : $\Phi 170$ mm
灯体 [Size] : $\Phi 195 \times H 107$ mm

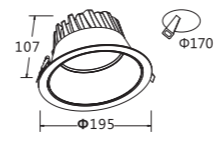

AW-TD051-8F

功率 [Power] : 40W
开孔 [Cutout] : $\Phi 200$ mm
灯体 [Size] : $\Phi 235 \times H 127.5$ mm

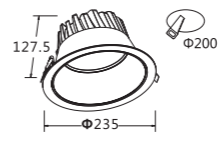

参数/Parameter

色温 [Color temp.] : 2700K | 3000K | 4000K | 5000K
材质 [Material] : Die-Cast Aluminum
环境温度 [Temp.] : $-20^{\circ}\text{C} \sim +50^{\circ}\text{C}$
灯体颜色 [Body color] : WH

光学角度/Beam



50°
Wide

芯片/Chip



COB

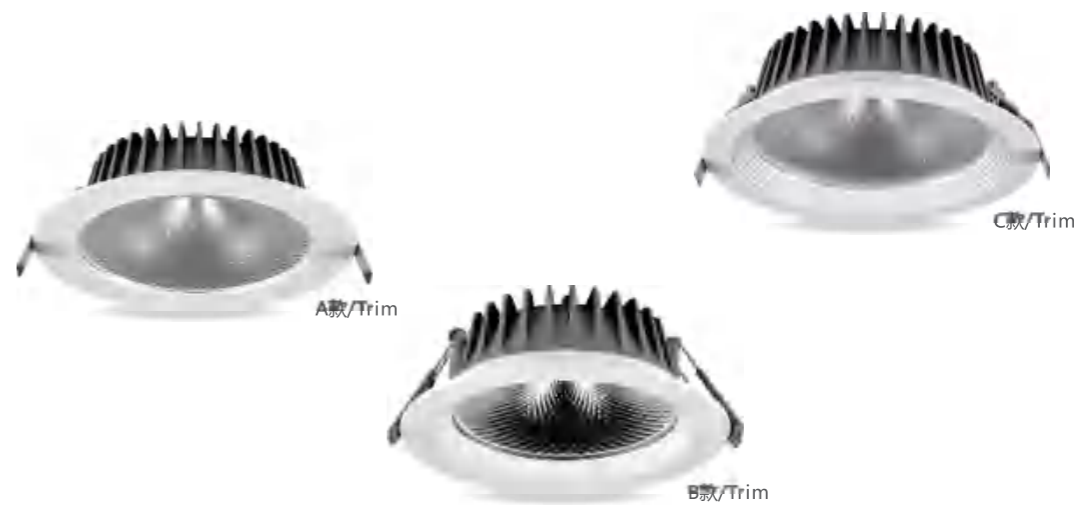

AW-TD055-2.5F

功率 [Power] : 3W
 开孔 [Cutout] : Φ 70mm
 灯体 [Size] : A/ Φ 98 \times H31mm
 B/C/ Φ 98 \times H36mm

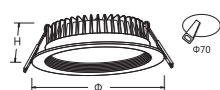

AW-TD055-3F

功率 [Power] : 5W
 开孔 [Cutout] : Φ 80mm
 灯体 [Size] : A/ Φ 108 \times H31mm
 B/C/ Φ 108 \times H36mm

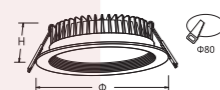

AW-TD055-3.5F

功率 [Power] : 7W
 开孔 [Cutout] : Φ 90mm
 灯体 [Size] : A/ Φ 118 \times H31.5mm
 B/C/ Φ 118 \times H36mm

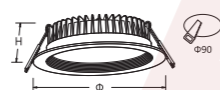

AW-TD055-4F

功率 [Power] : 9W
 开孔 [Cutout] : Φ 115mm
 灯体 [Size] : A/ Φ 138 \times H32mm
 B/C/ Φ 138 \times H38.5mm

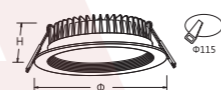

AW-TD055-5F

功率 [Power] : 12W
 开孔 [Cutout] : Φ 155mm
 灯体 [Size] : A/ Φ 178 \times H36mm
 B/C/ Φ 180 \times H43.5mm

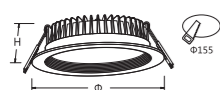

AW-TD055-6F

功率 [Power] : 20W
 开孔 [Cutout] : Φ 160mm
 灯体 [Size] : A/ Φ 188 \times H36mm
 B/C/ Φ 190 \times H45mm

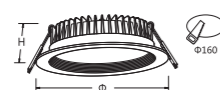

AW-TD055-8F

功率 [Power] : 30W
 开孔 [Cutout] : Φ 210mm
 灯体 [Size] : A/ Φ 240 \times H40mm
 B/C/ Φ 240 \times H56mm

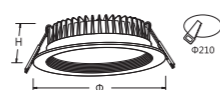

参数/Parameter

色温 [Color temp.] : 2700K | 3000K | 4000K | 5000K
 材质 [Material] : Aluminum+Die-Cast Aluminum
 环境温度 [Temp.] : -20°C~+50°C
 灯体颜色 [Body color] : WH+GREY

芯片/Chip



SMD

AW-TD056-2.5F

功率 [Power] : 5W
 开孔 [Cutout] : Φ 70mm
 灯体 [Size] : A/ Φ 98 \times H40mm
 B/C/ Φ 98 \times H51mm



AW-TD056-3F

功率 [Power] : 7W
 开孔 [Cutout] : Φ 80mm
 灯体 [Size] : A/ Φ 108 \times H41mm
 B/C/ Φ 108 \times H54mm



AW-TD056-3.5F

功率 [Power] : 9W
 开孔 [Cutout] : Φ 90mm
 灯体 [Size] : A/ Φ 118 \times H41mm
 B/C/ Φ 118 \times H54mm



AW-TD056-4F

功率 [Power] : 12W
 开孔 [Cutout] : Φ 115mm
 灯体 [Size] : A/ Φ 138 \times H53mm
 B/C/ Φ 138 \times H60mm

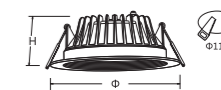

AW-TD056-5F

功率 [Power] : 15W
 开孔 [Cutout] : Φ 155mm
 灯体 [Size] : A/ Φ 178 \times H63mm
 B/C/ Φ 180 \times H70mm



AW-TD056-6F

功率 [Power] : 20W
 开孔 [Cutout] : Φ 160mm
 灯体 [Size] : A/ Φ 188 \times H68mm
 B/C/ Φ 190 \times H78mm



AW-TD056-8F

功率 [Power] : 30W
 开孔 [Cutout] : Φ 210mm
 灯体 [Size] : A/ Φ 240 \times H75mm
 B/C/ Φ 240 \times H93mm



参数/Parameter

色温 [Color temp.] : 2700K | 3000K | 4000K | 5000K
 材质 [Material] : Aluminum+Die-Cast Aluminum
 环境温度 [Temp.] : -20°C~+50°C
 灯体颜色 [Body color] : WH+GREY

光学角度/Beam



60° Wide

芯片/Chip



COB

西磁 (CITIZEN)



AW-TD058-4F

功率 [Power] : 12W
 开孔 [Cutout] : L105×W105mm
 灯体 [Size] : L120×W120×H51mm

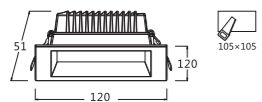

AW-TD058-6F

功率 [Power] : 20W
 开孔 [Cutout] : L145×W145mm
 灯体 [Size] : L167×W167×H54mm

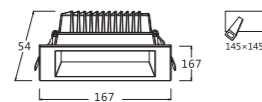

AW-TD058-8F

功率 [Power] : 25W
 开孔 [Cutout] : L185×W185mm
 灯体 [Size] : L215×W215×H55mm

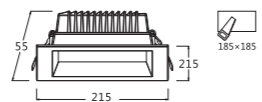

参数/Parameter

色温 [Color temp.] : 2700K | 3000K | 4000K | 5000K
 材质 [Material] : Die-Cast Aluminum
 环境温度 [Temp.] : -20°C~+50°C
 灯体颜色 [Body color] : WH

芯片/Chip



SMD



TD053A



TD053B

AW-TD053-3F

功率 [Power] : 10W
 开孔 [Cutout] : Φ95mm
 灯体 [Size] : Φ110×H61mm

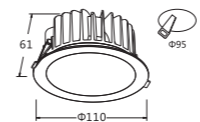

AW-TD053-4F

功率 [Power] : 15W
 开孔 [Cutout] : Φ110mm
 灯体 [Size] : Φ135×H69mm

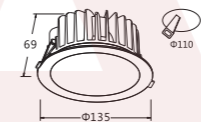

AW-TD053-5F

功率 [Power] : 25W
 开孔 [Cutout] : Φ130mm
 灯体 [Size] : Φ160×H75mm

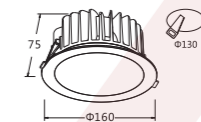

AW-TD053-6F

功率 [Power] : 40W
 开孔 [Cutout] : Φ165mm
 灯体 [Size] : Φ185×H100mm

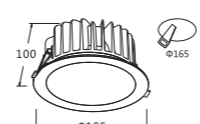

AW-TD053-8F

功率 [Power] : 60W
 开孔 [Cutout] : Φ205mm
 灯体 [Size] : Φ240×H120mm

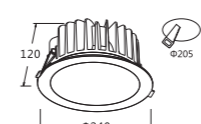

参数/Parameter

色温 [Color temp.] : 2700K | 3000K | 4000K | 5000K
 材质 [Material] : Die-Cast Aluminum
 环境温度 [Temp.] : -20°C~+50°C
 灯体颜色 [Body color] : WH

光学角度/Beam



50°
Wide

芯片/Chip



COB



SMD

LACAZ



AW-TD065-2F

功率 [Power]: 5W
 开孔 [Cutout]: 75mm
 灯体 [Size]: 中80×H40mm



AW-TD065-3F

功率 [Power]: 7W
 开孔 [Cutout]: 85mm
 灯体 [Size]: 中96×H47mm



AW-TD065-3.5F

功率 [Power]: 9W
 开孔 [Cutout]: 100mm
 灯体 [Size]: 113×H55mm



AW-TD065-4F

功率 [Power]: 12W
 开孔 [Cutout]: 120mm
 灯体 [Size]: 138×H64mm



AW-TD065-5F

功率 [Power]: 15W
 开孔 [Cutout]: 140mm
 灯体 [Size]: 165×H74mm



AW-TD065-6F

功率 [Power]: 20W
 开孔 [Cutout]: 170mm
 灯体 [Size]: 195×H85mm

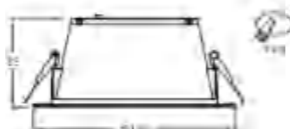

AW-TD065-8F

[Power]: 30W
 [Cutout]: 200mm
 [Size]: 228×H97mm



可选颜色/Optiona Color



银色/SL 铬色/CH 白色/WH

光学角度/Beam



60° Flood

芯片/Chip



COB

SMD



LACAZ

GD003

Track Light

TRACK

Light



GD003-D60

[Power] : 10W
[Size] : Φ60×H100mm

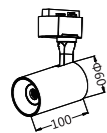

GD003-D80

[Power] : 20W
[Size] : Φ80×H120mm

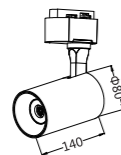

GD003-D90

[Power] : 30W
[Size] : Φ90×H140mm

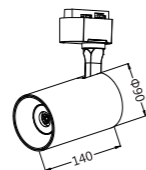

Parameter

[Color temp.] : 2700K | 3000K | 4000K | 5000K

[Material] : Aluminum+PC

[Temp.] : -20°C~+50°C

[Body color] : WH | BK

/Beam

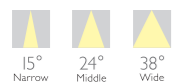

/Chip

