

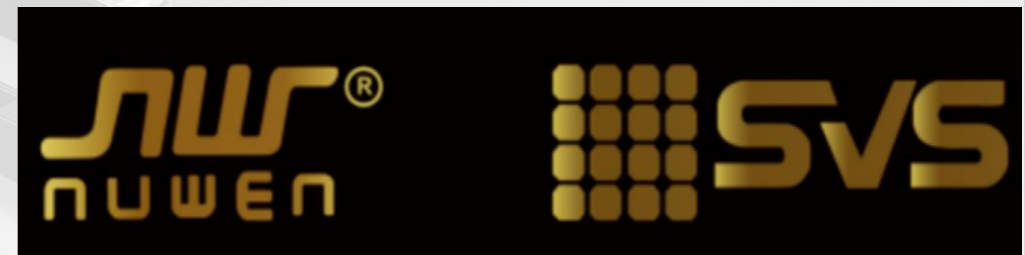

LACAZ<sup>®</sup>



NUWEN

NUWEN CO.,LTD  
Add:Unit 1,no.187,Xiayang road,Hetang Town ,Pengjiang District,  
Jiangmen City,Guangdong Province , China.

E-mail: nuwen.china.2020@gmail.com  
Mobile: +86-18680577977  
WeChat/Whats app: +86-18680577977

+866-18680577977





CX5  
CX5 Series

NUWEN

866-18680577977

NEW

NUWEN<sup>®</sup>



**CX05-GS-300**

尺寸 [Size]: 330x11x24.5mm  
功率 [Power]: 8W  
电压 [Voltage]: 48V  
材质 [Material]: Aluminium

光学角度/Beam  
70°

芯片/Chip  
Bridgelux2835  
SMD

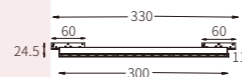

NEW

NUWEN<sup>®</sup>



**CX05-FG-300**

尺寸 [Size]: 330x11x24.5mm  
功率 [Power]: 8W  
电压 [Voltage]: 48V  
材质 [Material]: Aluminium

芯片/Chip  
Bridgelux2835  
SMD

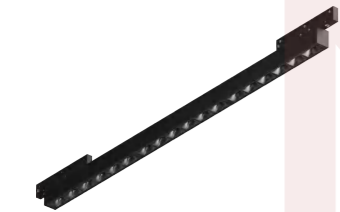
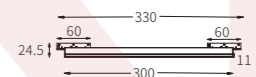

**CX05-GS-600**

尺寸 [Size]: 630x11x24.5mm  
功率 [Power]: 16W  
电压 [Voltage]: 48V  
材质 [Material]: Aluminium

光学角度/Beam  
70°

芯片/Chip  
Bridgelux2835  
SMD

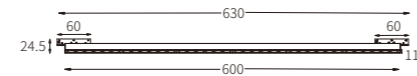

**CX05-FG-600**

尺寸 [Size]: 630x11x24.5mm  
功率 [Power]: 16W  
电压 [Voltage]: 48V  
材质 [Material]: Aluminium

芯片/Chip  
Bridgelux2835  
SMD

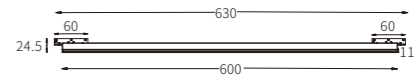

+866-18680577977

NEW

CX05

NUWEN<sup>®</sup>



NEW

CX05

NUWEN<sup>®</sup>

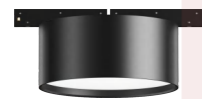

**CX05-MD-90**

尺寸 [Size]:  $\Phi 90 \times 46 \text{mm}$   
功率 [Power]: 9W  
电压 [Voltage]: 48V  
材质 [Material]: Aluminium

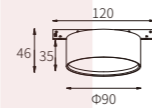

光学角度/Beam  
90°

芯片/Chip  
Bridgelux2835  
SMD

**CX05-MD25A**

尺寸 [Size]:  $\Phi 25 \times 72 \text{mm}$   
功率 [Power]: 3W  
电压 [Voltage]: 48V  
材质 [Material]: Aluminium

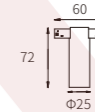

光学角度/Beam  
15° 24° 36°

芯片/Chip  
Bridgelux3535  
SMD



**CX05-WW-80**

尺寸 [Size]:  $\Phi 80 \times 100 \text{mm}$   
功率 [Power]: 5W  
电压 [Voltage]: 48V  
材质 [Material]: Aluminium

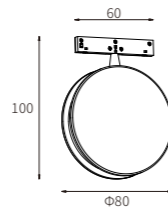

芯片/Chip  
Bridgelux2835  
SMD



**CX05-MD35A**

尺寸 [Size]:  $\Phi 35 \times 85 \text{mm}$   
功率 [Power]: 5W  
电压 [Voltage]: 48V  
材质 [Material]: Aluminium

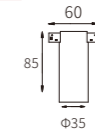

光学角度/Beam  
15° 24° 36°

芯片/Chip  
Bridgelux  
COB



**CX05-MD45A**

尺寸 [Size]:  $\Phi 45 \times 82 \text{mm}$   
功率 [Power]: 9W  
电压 [Voltage]: 48V  
材质 [Material]: Aluminium

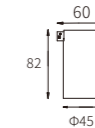

光学角度/Beam  
15° 24° 36°

芯片/Chip  
Bridgelux  
COB

+866-18680577977

NEW

CX05



### CX05-MD25B

尺寸 [Size]:  $\Phi 25 \times 60 \text{mm}$   
功率 [Power]: 3W  
电压 [Voltage]: 48V  
材质 [Material]: Aluminium

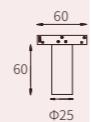
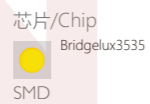

### CX05-MD35B

尺寸 [Size]:  $\Phi 35 \times 80 \text{mm}$   
功率 [Power]: 5W  
电压 [Voltage]: 48V  
材质 [Material]: Aluminium

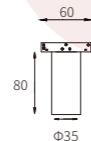
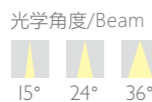

### CX05-MD45B

尺寸 [Size]:  $\Phi 45 \times 70 \text{mm}$   
功率 [Power]: 9W  
电压 [Voltage]: 48V  
材质 [Material]: Aluminium

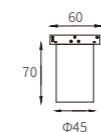
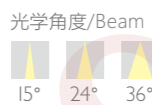

NEW

CX05



### CX05-GD25

尺寸 [Size]:  $\Phi 25 \times 68 \text{mm}$   
功率 [Power]: 3W  
电压 [Voltage]: 48V  
材质 [Material]: Aluminium

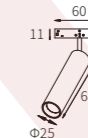
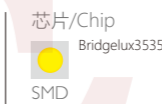
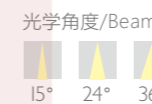

### CX05-GD35

尺寸 [Size]:  $\Phi 35 \times 80 \text{mm}$   
功率 [Power]: 5W  
电压 [Voltage]: 48V  
材质 [Material]: Aluminium



### CX05-GD45

尺寸 [Size]:  $\Phi 45 \times 78 \text{mm}$   
功率 [Power]: 9W  
电压 [Voltage]: 48V  
材质 [Material]: Aluminium

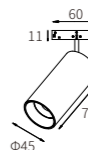
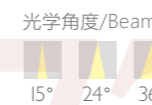

+8666-18680577977

NEW

CX05



**CX05-RX-500**

尺寸 [Size]: 500mm  
功率 [Power]: 4W  
电压 [Voltage]: 48V  
材质 [Material]: Aluminium

芯片/Chip  
Bridgelux  
SMD

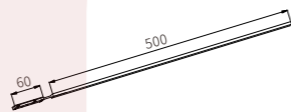

NUWEN

NEW

CX05

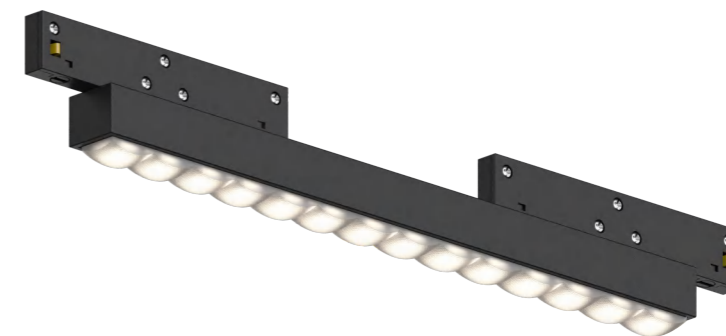

**CX05-GS-14**

尺寸 [Size]: 170x11x22mm  
功率 [Power]: 5W  
电压 [Voltage]: 48V  
材质 [Material]: Aluminium

光学角度/Beam  
40° | 芯片/Chip  
Bridgelux  
SMD

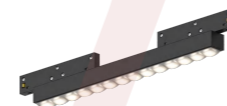
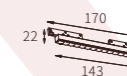

**CX05-GS-28**

尺寸 [Size]: 311x11x22mm  
功率 [Power]: 10W  
电压 [Voltage]: 48V  
材质 [Material]: Aluminium

光学角度/Beam  
40° | 芯片/Chip  
Bridgelux  
SMD

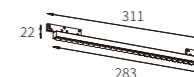

**CX05-RX-1000**

尺寸 [Size]: 1000mm  
功率 [Power]: 8W  
电压 [Voltage]: 48V  
材质 [Material]: Aluminium

芯片/Chip  
Bridgelux  
SMD

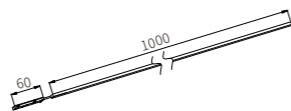

+866-18680577977

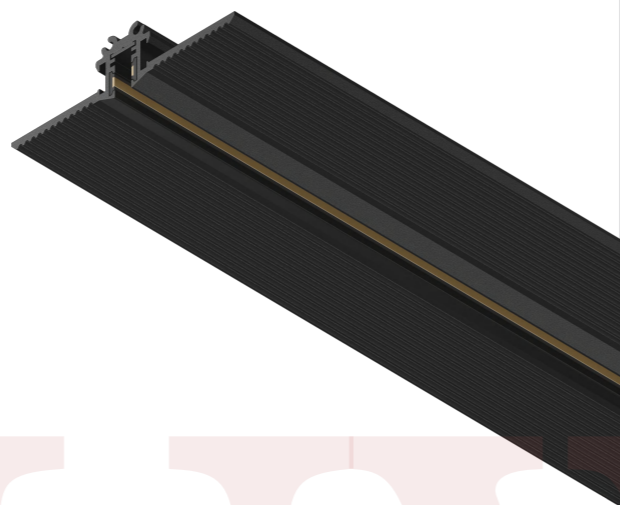

**CX05-R-J**

尺寸 [Size]: 50x16.4mm  
材质 [Material]: Aluminium

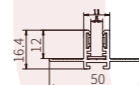

**CX05-D-D**

尺寸 [Size]:  $\Phi 10 \times 32\text{mm} / \Phi 15 \times 17.5\text{mm}$   
材质 [Material]: Steel

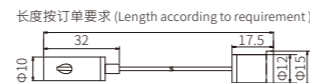

**CX05-M-G**

尺寸 [Size]: 13.7x11mm  
材质 [Material]: Aluminium



**CX05-R-G**

尺寸 [Size]: 70x13.7mm  
材质 [Material]: Aluminium

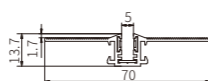
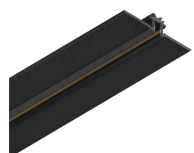

**CX05-C-C\*2**  
尺寸 [Size]: 170mm  
材质 [Material]: PC

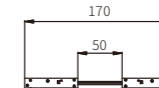

**CX05-C-J**  
尺寸 [Size]: 60x11mm  
材质 [Material]: PC

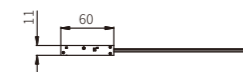

**CX05-C-M-Z**  
尺寸 [Size]: 50x50mm  
材质 [Material]: Aluminium

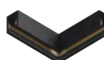

**CX05-C-M-L**  
尺寸 [Size]: 50x50mm  
材质 [Material]: Aluminium



**CX05-C-R-Z**  
尺寸 [Size]: 50x50mm  
材质 [Material]: Aluminium

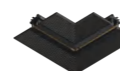

**CX05-C-R-L**  
尺寸 [Size]: 100x100mm  
材质 [Material]: Aluminium



**CX05-C-J-Z**  
尺寸 [Size]: 50x50mm  
材质 [Material]: Aluminium



**CX05-C-J-L**  
尺寸 [Size]: 50x50mm  
材质 [Material]: Aluminium



+866-18680577977



CX11系列  
CX11 Series

4866-18680577977



**CX II-F-FG-300**

尺寸 [Size]: 348x11x8.9mm  
 功率 [Power]: 6W  
 电压 [Voltage]: 48V  
 材质 [Material]: Aluminium+PC  
 芯片/Chip  
 Orsam2835  
 SMD

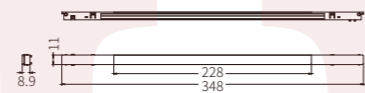

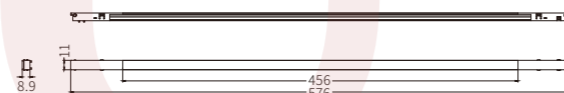

**CX II-F-FG-600**

尺寸 [Size]: 576x11x8.9mm  
 功率 [Power]: 12W  
 电压 [Voltage]: 48V  
 材质 [Material]: Aluminium+PC  
 芯片/Chip  
 Orsam2835  
 SMD



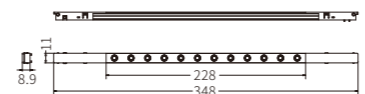

**CX II-F-GS-I2**

尺寸 [Size]: 348x11x8.9mm  
 功率 [Power]: 6W  
 电压 [Voltage]: 48V  
 材质 [Material]: Aluminium+PC  
 光学角度/Beam  
 40°  
 芯片/Chip  
 SMD



**CX II-F-GS-24**

尺寸 [Size]: 576x11x8.9mm  
 功率 [Power]: 12W  
 电压 [Voltage]: 48V  
 材质 [Material]: Aluminium+PC  
 光学角度/Beam  
 40°  
 芯片/Chip  
 SMD

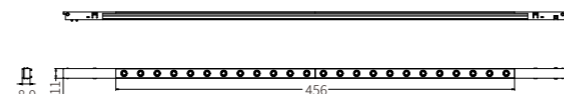

**CX II-GS-I2**

尺寸 [Size]: 235.5x11x25.6mm  
 功率 [Power]: 10W  
 电压 [Voltage]: 48V  
 材质 [Material]: Aluminium

光学角度/Beam  
 36°  
 芯片/Chip  
 Orsam3030  
 SMD

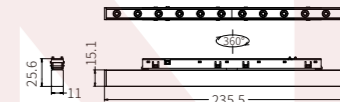

**CX II-GS-A-I2**

尺寸 [Size]: 230.7x15.7x66.9mm  
 功率 [Power]: 12W  
 电压 [Voltage]: 48V  
 材质 [Material]: Die casting aluminium

光学角度/Beam  
 24°  
 芯片/Chip  
 Orsam3030  
 SMD

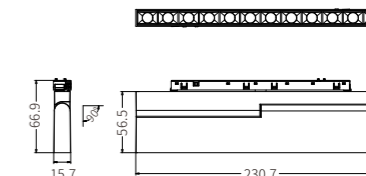

+866-18680577977



**CXII-GD16**

尺寸 [Size]:  $\Phi 16 \times 80 \text{mm}$   
 功率 [Power]: 3W  
 电压 [Voltage]: 48V  
 材质 [Material]: Aluminium

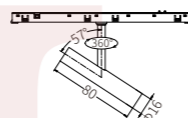

**CXII-GD20**

尺寸 [Size]:  $\Phi 20 \times 100 \text{mm}$   
 功率 [Power]: 5W  
 电压 [Voltage]: 48V  
 材质 [Material]: Aluminium

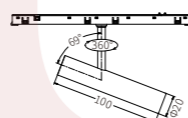

**CXII-GD30**

尺寸 [Size]:  $\Phi 30 \times 120 \text{mm}$   
 功率 [Power]: 9W  
 电压 [Voltage]: 48V  
 材质 [Material]: Aluminium

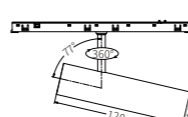

**CXII-GD50**

尺寸 [Size]:  $\Phi 50 \times 19 \times 67 \text{mm}$   
 功率 [Power]: 5W  
 电压 [Voltage]: 48V  
 材质 [Material]: Aluminium

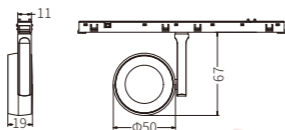

**CXII-M-R03**

尺寸 [Size]:  $\Phi 47.4 \times 75 \text{mm}$   
 功率 [Power]: 6W  
 电压 [Voltage]: 48V  
 材质 [Material]: Aluminium

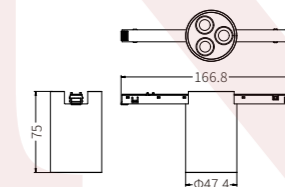

可选光学种类/Optics



可选光学角度/Beam



可选灯体颜色/Fixture Colors

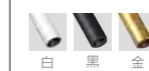

防眩罩可选颜色/Reflector Colors



芯片/Chip



**CXII-M-C48**

尺寸 [Size]:  $\Phi 47.4 \times 75 \text{mm}$   
 功率 [Power]: 6W  
 电压 [Voltage]: 48V  
 材质 [Material]: Aluminium

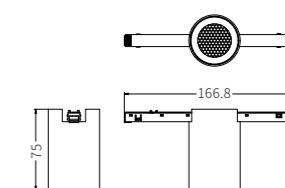

可选光学角度/Beam

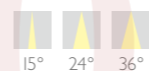

可选灯体颜色/Fixture Colors



防眩罩可选颜色/Reflector Colors



芯片/Chip



+86-18680577977

NEW  
CXII

NUWEN<sup>®</sup>

NEW  
CXII

NUWEN<sup>®</sup>



**CXII-M-R04**

尺寸 [Size]:  $\Phi 54.4 \times 80$ mm  
功率 [Power]: 10W  
电压 [Voltage]: 48V  
材质 [Material]: Aluminium

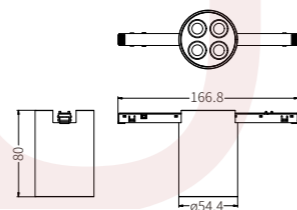

**CXII-R-G**

尺寸 [Size]: 25.5x14.3mm  
材质 [Material]: Aluminium



**CXII-M-G**

尺寸 [Size]: 19.5x12.1mm  
材质 [Material]: Aluminium

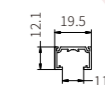

可选光学种类/Optics



凸面防眩罩

可选光学角度/Beam



26° 38°

可选灯体颜色/Fixture Colors



白 W 黑 B 金 G

防眩罩可选颜色/Reflector Colors



外白内黑 W+B 外白内金 W+G 外黑内金 B+G 全黑 B

芯片/Chip



Orsam3030 CSP SMD



**CXII-M-S04**

尺寸 [Size]: 43.9x43.9x75mm  
功率 [Power]: 10W  
电压 [Voltage]: 48V  
材质 [Material]: Aluminium

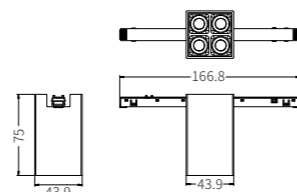

**CXII-R-G**

尺寸 [Size]: 49.4x12.1mm  
材质 [Material]: Aluminium

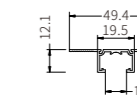

**CXII-100W电源**

尺寸 [Size]: 235.5x18x31.1mm  
材质 [Material]: Aluminium +PC

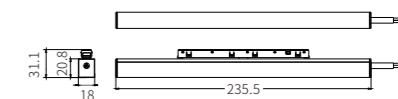

**CXII-150W电源**

尺寸 [Size]: 305.5x18x31.1mm  
材质 [Material]: Aluminium +PC

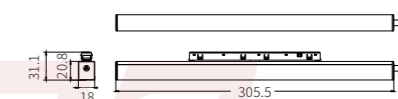

可选光学种类/Optics



凸面防眩罩

可选光学角度/Beam

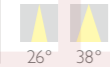

26° 38°

可选灯体颜色/Fixture Colors



白 W 黑 B 金 G

防眩罩可选颜色/Reflector Colors



外白内黑 W+B 外白内金 W+G 外黑内金 B+G 全黑 B

芯片/Chip



Orsam3030 CSP SMD



**CXII-Q-G 弹夹**

尺寸 [Size]: 40.5x30x37.7mm  
材质 [Material]: Iron

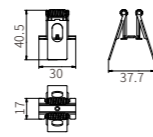

**CXII-M-G-SC(水平)**

尺寸 [Size]: 40x40mm  
材质 [Material]: Aluminium

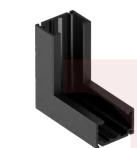
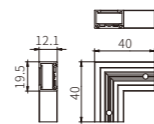

**CXII-M-G-ZC(直角)**

尺寸 [Size]: 40x40mm  
材质 [Material]: Aluminium

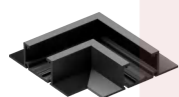
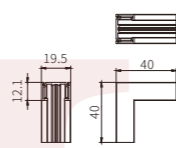

**CXII-R-G-SC(水平)**

尺寸 [Size]: 40x40mm  
材质 [Material]: Aluminium

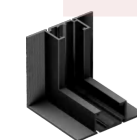
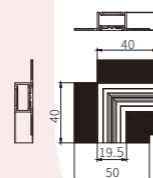

**CXII-R-G-ZC(直角)**

尺寸 [Size]: 40x40mm  
材质 [Material]: Aluminium

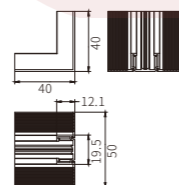

**CXII-RI-G-SC(水平)**

尺寸 [Size]: 40x40mm  
材质 [Material]: Aluminium

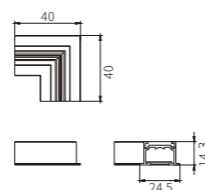

**CXII-RI-G-ZC(直角)**

尺寸 [Size]: 40x40mm  
材质 [Material]: Aluminium

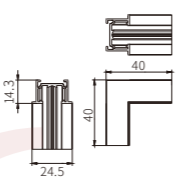

**CXII-C-XM**

尺寸 [Size]: 80.4x28.4x34.4mm  
材质 [Material]: PC

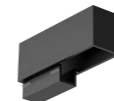
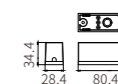

**CXII-C-XS**

尺寸 [Size]: 60x18x30.6mm  
材质 [Material]: PC

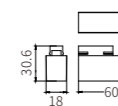

**CXII-C-C**

尺寸 [Size]: 120.4x11.1x9.7mm  
材质 [Material]: PC

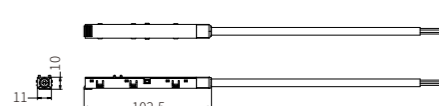

**CXII-C-LN(内)**

尺寸 [Size]: 111x110.8x11.1mm  
材质 [Material]: PC

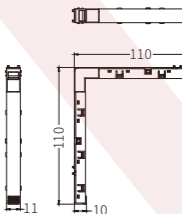

**CXII-C-LW(外)**

尺寸 [Size]: 110.2x110x11.1mm  
材质 [Material]: PC

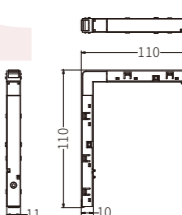

**CXII-C-LS(水平)**

尺寸 [Size]: 111.1x111.2x11.1mm  
材质 [Material]: PC

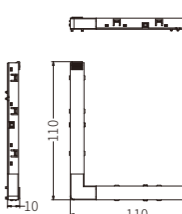

**CXII-C-I**

尺寸 [Size]: 200.7x11.1x9.7mm  
材质 [Material]: PC



+866-18680577977



**CX10系列**  
CX10 Series

+866-18680577977

NEW

CX10



**CX10-GS-I2**

尺寸 [Size]: 231.3x11.8x19.5mm  
功率 [Power]: 8W  
电压 [Voltage]: 24V  
材质 [Material]: Aluminium

光学角度/Beam  
24°

芯片/Chip  
Orsam3030  
SMD

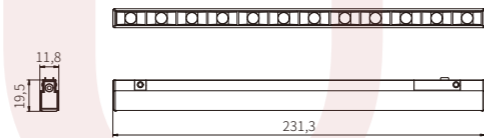

NEW

CX10



**CX10-GS-A-06**

尺寸 [Size]: 118.3x11.8x34mm  
功率 [Power]: 4W  
电压 [Voltage]: 24V  
材质 [Material]: Aluminium

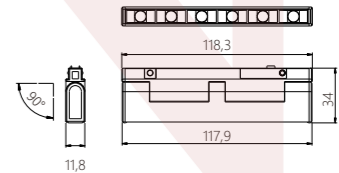

**CX10-FG-I2**

尺寸 [Size]: 231.3x11.8x19.5mm  
功率 [Power]: 8W  
电压 [Voltage]: 24V  
材质 [Material]: Aluminium

芯片/Chip  
Orsam3030  
SMD

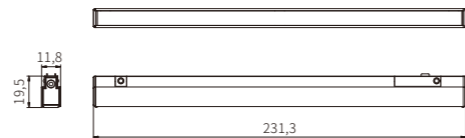

**CX10-GS-06**

尺寸 [Size]: 117.3x11.8x19.5mm  
功率 [Power]: 4W  
电压 [Voltage]: 24V  
材质 [Material]: Aluminium

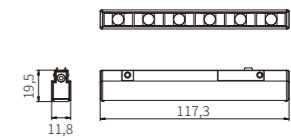

光学角度/Beam  
24°

芯片/Chip  
Orsam3030  
SMD

+866-18680577977



**CX10-GD50**

尺寸 [Size]:  $\Phi 50 \times 19 \times 67 \text{mm}$   
 功率 [Power]: 5W  
 电压 [Voltage]: 24V  
 材质 [Material]: Aluminium

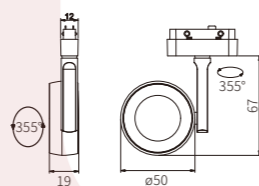

**CX10-GD18**

尺寸 [Size]:  $\Phi 18 \times 40 \text{mm}$   
 功率 [Power]: 1.5W  
 电压 [Voltage]: 24V  
 材质 [Material]: Aluminium

光学角度/Beam

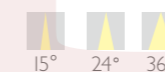

芯片/Chip

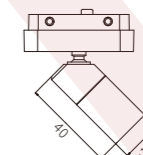

**CX10-GD30**

尺寸 [Size]:  $\Phi 30.5 \times 65 \text{mm}$   
 功率 [Power]: 5W  
 电压 [Voltage]: 24V  
 材质 [Material]: Aluminium

光学角度/Beam

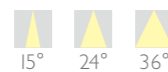

芯片/Chip

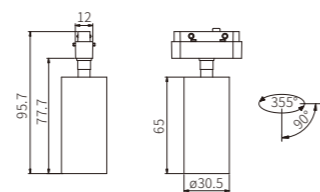

**CX10-GD15\*2**

尺寸 [Size]:  $\Phi 15 \times 29 \text{mm}$   
 功率 [Power]: 2\*1.5W  
 电压 [Voltage]: 24V  
 材质 [Material]: Aluminium

光学角度/Beam



芯片/Chip

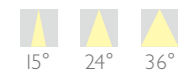
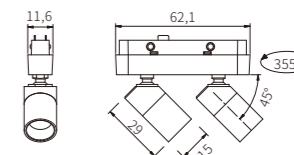



**CX10-C-C\*2**  
尺寸 [Size]: 71.7x81.7x8.3mm  
材质 [Material]: PC

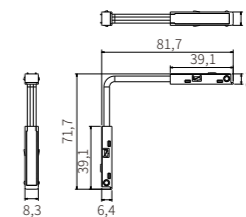

**CX10-C-C**  
尺寸 [Size]: 39.1x8.3x6.4mm  
材质 [Material]: PC

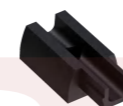
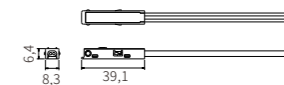

**CX10-C-XS**  
尺寸 [Size]: 31x15.2x10mm  
材质 [Material]: PC

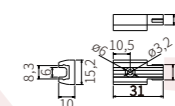

**CX10-C-L**  
尺寸 [Size]: 40.1x40.1x10mm  
材质 [Material]: PC

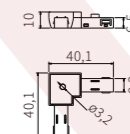

**CX10-C-I**  
尺寸 [Size]: 65x15.2x10mm  
材质 [Material]: PC

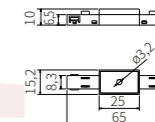

**CX10-C-T**  
尺寸 [Size]: 65x10.1x10mm  
材质 [Material]: PC

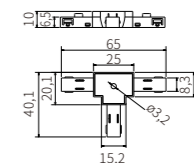

**CX10-C-X**  
尺寸 [Size]: 65x65x10mm  
材质 [Material]: PC

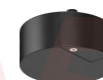
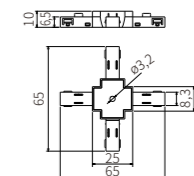

**CX10-80W/I20W**  
尺寸 [Size]:  $\Phi$ 74x35.6mm  
材质 [Material]: PC

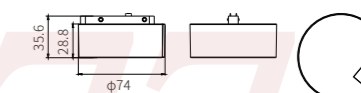

**CX10-M-G**  
尺寸 [Size]: 15x10mm  
材质 [Material]: Aluminium



**CX10-MI-G**  
尺寸 [Size]: 35.2x10mm  
材质 [Material]: Aluminium

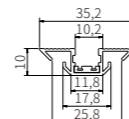

**CX10-R-G**  
尺寸 [Size]: 37.8x10mm  
材质 [Material]: Aluminium

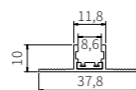



**HTSD3-LS-R35**

尺寸 [Size]:  $\Phi 40 \times 98.5 \text{mm}$   
 开孔尺寸 [Cut Hole]:  $\Phi 35 \text{mm}$   
 功率 [Power]: 3W  
 材质 [Material]: Aluminium

**HTSD3-LS-R45**

尺寸 [Size]:  $\Phi 50 \times 118.5 \text{mm}$   
 开孔尺寸 [Cut Hole]:  $\Phi 45 \text{mm}$   
 功率 [Power]: 5W  
 材质 [Material]: Aluminium



**HTSD3-LS-B-R35**

尺寸 [Size]:  $\Phi 64.5 \times 98.5 \text{mm}$   
 开孔尺寸 [Cut Hole]:  $\Phi 35 \text{mm}$   
 功率 [Power]: 3W  
 材质 [Material]: Aluminium

**HTSD3-LS-B-R45**

尺寸 [Size]:  $\Phi 78.5 \times 118.5 \text{mm}$   
 开孔尺寸 [Cut Hole]:  $\Phi 45 \text{mm}$   
 功率 [Power]: 5W  
 材质 [Material]: Aluminium

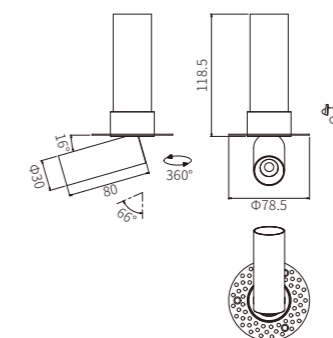
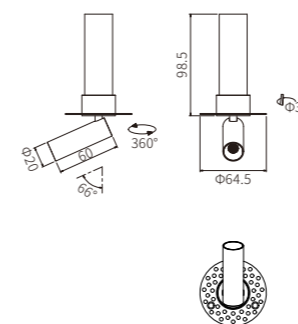
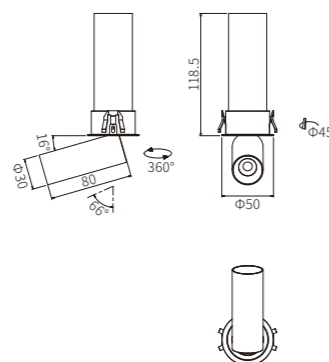
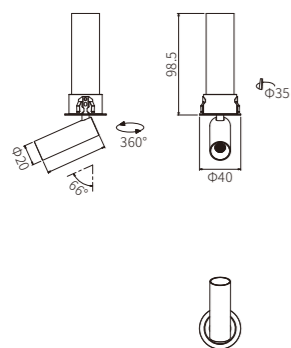

光学角度/Beam



芯片/Chip

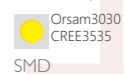

SMD

光学角度/Beam

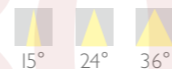

芯片/Chip



SMD

+866-18680577977



**HTSD3-F-R20**

尺寸 [Size]:  $\Phi 25 \times 57 \text{mm}$   
 $\Phi 25 \times 98 \text{mm}$   
 开孔尺寸 [Cut Hole]:  $\Phi 20 \text{mm}$   
 功率 [Power]: 3W / 5W  
 材质 [Material]: Aluminium

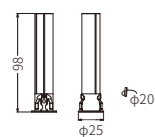
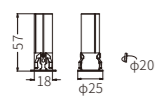

**HTSD3-F-R30**

尺寸 [Size]:  $\Phi 35 \times 76.5 \text{mm}$   
 $\Phi 35 \times 93.5 \text{mm}$   
 开孔尺寸 [Cut Hole]:  $\Phi 30 \text{mm}$   
 功率 [Power]: 5W / 7W  
 材质 [Material]: Aluminium

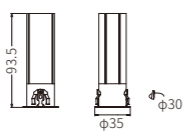
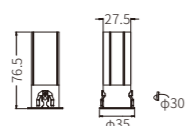

**HTSD3-F-R40**

尺寸 [Size]:  $\Phi 45 \times 97.5 \text{mm}$   
 $\Phi 45 \times 150.5 \text{mm}$   
 开孔尺寸 [Cut Hole]:  $\Phi 40 \text{mm}$   
 功率 [Power]: 7W / 10W  
 材质 [Material]: Aluminium

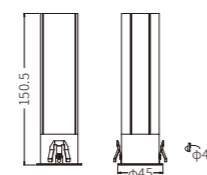
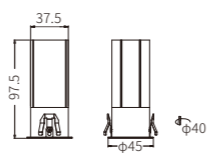

**HTSD3-F-R50**

尺寸 [Size]:  $\Phi 55 \times 103 \text{mm}$   
 $\Phi 55 \times 133 \text{mm}$   
 开孔尺寸 [Cut Hole]:  $\Phi 50 \text{mm}$   
 功率 [Power]: 12W / 15W  
 材质 [Material]: Aluminium

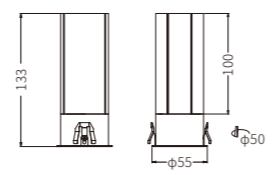
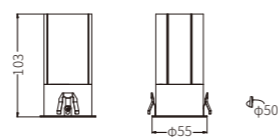

**HTSD3-FB-R25**

尺寸 [Size]:  $\Phi 52.5 \times 57 \text{mm}$   
 $\Phi 52.5 \times 98 \text{mm}$   
 开孔尺寸 [Cut Hole]:  $\Phi 25 \text{mm}$   
 功率 [Power]: 3W / 5W  
 材质 [Material]: Aluminium

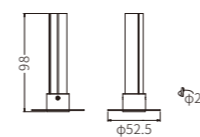
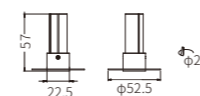

**HTSD3-FB-R35**

尺寸 [Size]:  $\Phi 64.5 \times 76.5 \text{mm}$   
 $\Phi 64.5 \times 93.5 \text{mm}$   
 开孔尺寸 [Cut Hole]:  $\Phi 35 \text{mm}$   
 功率 [Power]: 5W / 7W  
 材质 [Material]: Aluminium

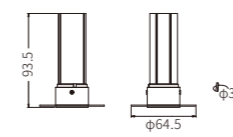
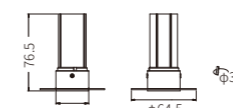

**HTSD3-FB-R45**

尺寸 [Size]:  $\Phi 78.5 \times 97.5 \text{mm}$   
 $\Phi 78.5 \times 150.5 \text{mm}$   
 开孔尺寸 [Cut Hole]:  $\Phi 45 \text{mm}$   
 功率 [Power]: 7W / 10W  
 材质 [Material]: Aluminium

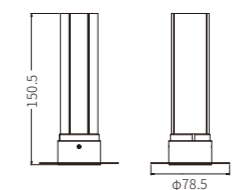
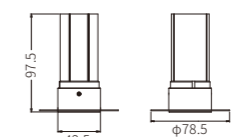

**HTSD3-FB-R55**

尺寸 [Size]:  $\Phi 88.5 \times 103 \text{mm}$   
 $\Phi 88.5 \times 133 \text{mm}$   
 开孔尺寸 [Cut Hole]:  $\Phi 55 \text{mm}$   
 功率 [Power]: 12W / 15W  
 材质 [Material]: Aluminium

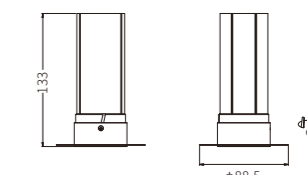
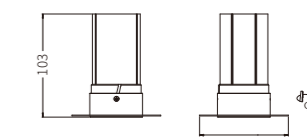

光学角度/Beam



可选颜色/Reflector Colors



芯片/Chip



光学角度/Beam

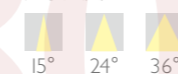

可选颜色/Reflector Colors



芯片/Chip



4866-18680577977



### HTSD3-A-R25

尺寸 [Size]:  $\Phi 30 \times 60 \text{mm}$   
 $\Phi 30 \times 101.5 \text{mm}$   
 开孔尺寸 [Cut Hole]:  $\Phi 25 \text{mm}$   
 功率 [Power]: 3W / 5W  
 材质 [Material]: Aluminium

### HTSD3-A-R35

尺寸 [Size]:  $\Phi 40 \times 80 \text{mm}$   
 $\Phi 40 \times 97 \text{mm}$   
 开孔尺寸 [Cut Hole]:  $\Phi 35 \text{mm}$   
 功率 [Power]: 5W / 7W  
 材质 [Material]: Aluminium

### HTSD3-A-R45

尺寸 [Size]:  $\Phi 50 \times 100 \text{mm}$   
 $\Phi 50 \times 153 \text{mm}$   
 开孔尺寸 [Cut Hole]:  $\Phi 45 \text{mm}$   
 功率 [Power]: 7W / 10W  
 材质 [Material]: Aluminium

### HTSD3-A-R55

尺寸 [Size]:  $\Phi 60 \times 106.5 \text{mm}$   
 $\Phi 60 \times 136.5 \text{mm}$   
 开孔尺寸 [Cut Hole]:  $\Phi 55 \text{mm}$   
 功率 [Power]: 12W / 15W  
 材质 [Material]: Aluminium

### HTSD3-AB-R25

尺寸 [Size]:  $\Phi 52.5 \times 60 \text{mm}$   
 $\Phi 52.5 \times 101.5 \text{mm}$   
 开孔尺寸 [Cut Hole]:  $\Phi 25 \text{mm}$   
 功率 [Power]: 3W / 5W  
 材质 [Material]: Aluminium

### HTSD3-AB-R35

尺寸 [Size]:  $\Phi 64.5 \times 80 \text{mm}$   
 $\Phi 64.5 \times 97 \text{mm}$   
 开孔尺寸 [Cut Hole]:  $\Phi 35 \text{mm}$   
 功率 [Power]: 5W / 7W  
 材质 [Material]: Aluminium

### HTSD3-AB-R45

尺寸 [Size]:  $\Phi 78.5 \times 100 \text{mm}$   
 $\Phi 78.5 \times 153 \text{mm}$   
 开孔尺寸 [Cut Hole]:  $\Phi 45 \text{mm}$   
 功率 [Power]: 7W / 10W  
 材质 [Material]: Aluminium

### HTSD3-AB-R55

尺寸 [Size]:  $\Phi 88.5 \times 106.5 \text{mm}$   
 $\Phi 88.5 \times 136.5 \text{mm}$   
 开孔尺寸 [Cut Hole]:  $\Phi 55 \text{mm}$   
 功率 [Power]: 12W / 15W  
 材质 [Material]: Aluminium

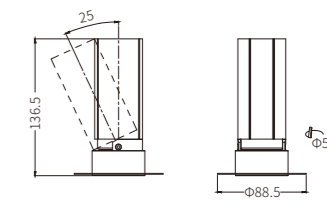
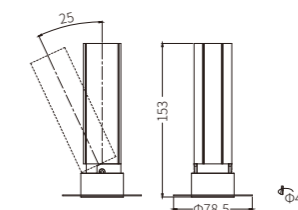
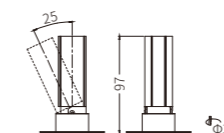
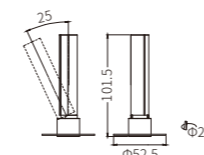
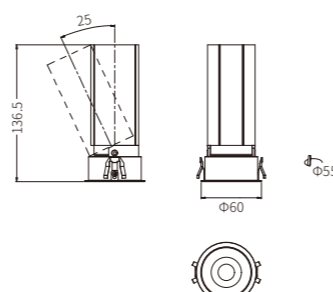
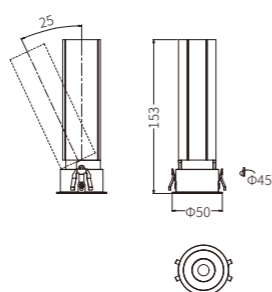
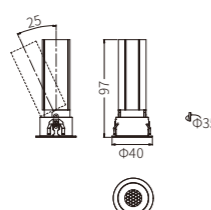
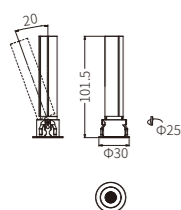
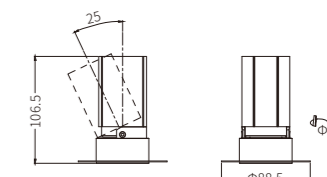
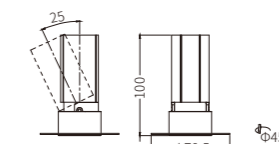
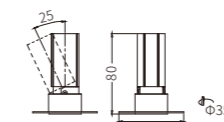
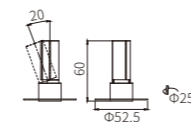
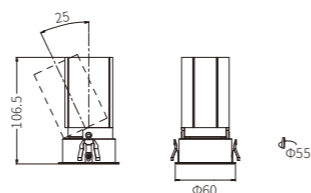
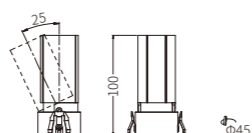
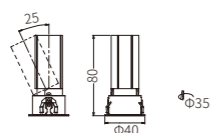
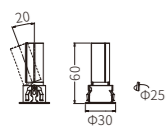

光学角度/Beam

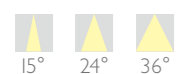

可选颜色/Reflector Colors



芯片/Chip



配件/Accessories



光学角度/Beam

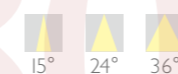

可选颜色/Reflector Colors

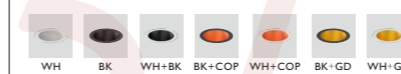

芯片/Chip



配件/Accessories



4866-18680577977

NEW  
HTSD3

HTSD3  
NUWEN

HTSD3  
NUWEN



### HTSD3-FC-R30

尺寸 [Size]:  $\Phi 35 \times 74.5 \text{mm}$   
开孔尺寸 [Cut Hole]:  $\Phi 30 \text{mm}$   
功率 [Power]: 5W  
材质 [Material]: Aluminium

### HTSD3-BC-R35

尺寸 [Size]:  $\Phi 64.3 \times 74.5 \text{mm}$   
开孔尺寸 [Cut Hole]:  $\Phi 35 \text{mm}$   
功率 [Power]: 5W  
材质 [Material]: Aluminium

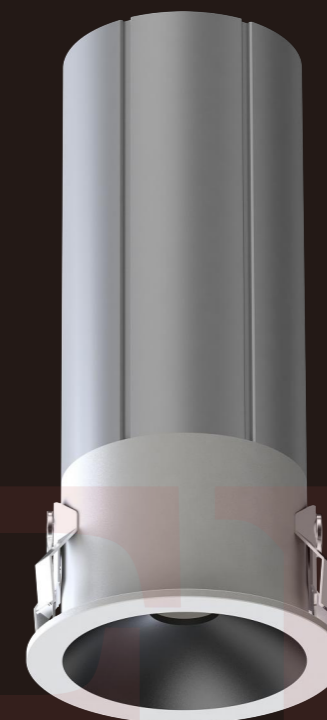
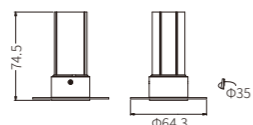
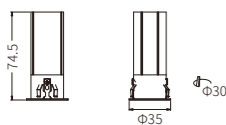

$\Phi 30$

光学角度/Beam



24°

可选颜色/Reflector Colors



芯片/Chip



NEW

HTSD3  
HTSD3



**HTSD3-WW-R35**

尺寸 [Size]:  $\Phi 40 \times 70 \text{mm}$   
开孔尺寸 [Cut Hole]:  $\Phi 35 \text{mm}$   
功率 [Power]: 5W  
材质 [Material]: Aluminium

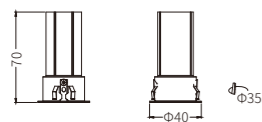

**HTSD3-WW-B-R35**

尺寸 [Size]:  $\Phi 64.5 \times 70 \text{mm}$   
开孔尺寸 [Cut Hole]:  $\Phi 35 \text{mm}$   
功率 [Power]: 5W  
材质 [Material]: Aluminium



$\Phi 35$

芯片/Chip

科锐 (CREE0410)  
COB

+866-1868 0577977

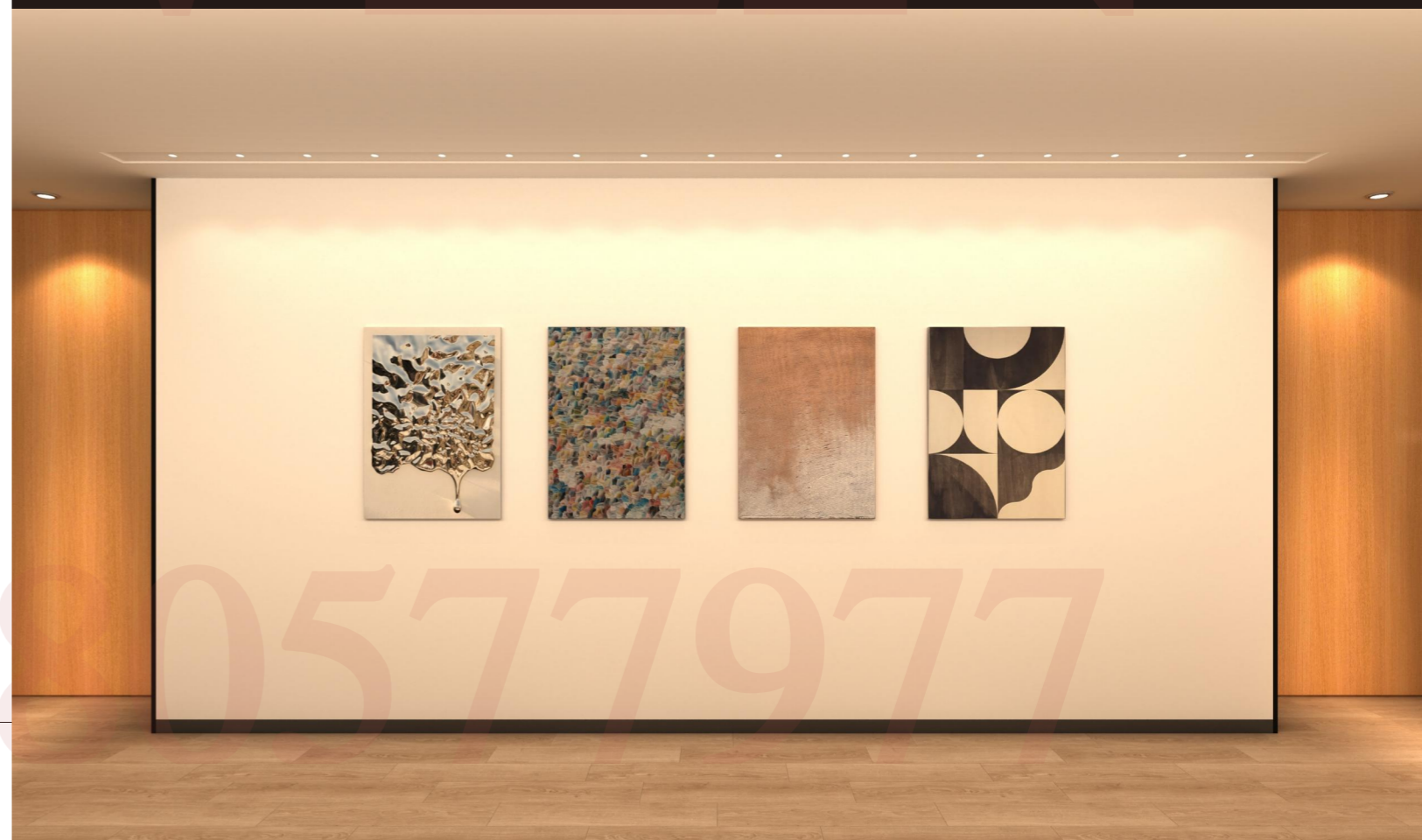

IP54

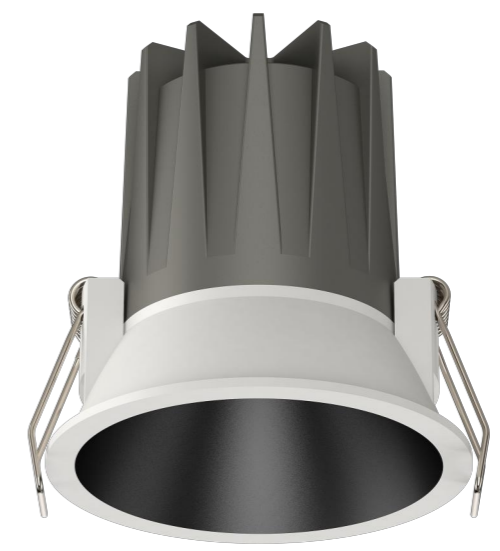

**TSD011-35**

尺寸 [Size]:  $\Phi 39 \times 50 \text{mm}$   
 开孔尺寸 [Cut Hole]:  $\Phi 35 \text{mm}$   
 功率 [Power]: 3W  
 材质 [Material]: Die casting aluminium+PC

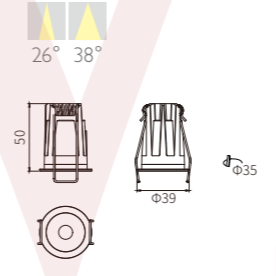

**TSD011-55**

尺寸 [Size]:  $\Phi 60 \times 68 \text{mm}$   
 开孔尺寸 [Cut Hole]:  $\Phi 55 \text{mm}$   
 功率 [Power]: 5W  
 材质 [Material]: Die casting aluminium+PC

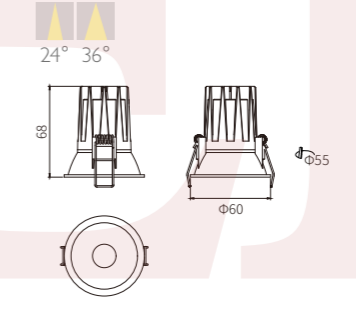

**TSD011-75**

尺寸 [Size]:  $\Phi 81 \times 85 \text{mm}$   
 开孔尺寸 [Cut Hole]:  $\Phi 75 \text{mm}$   
 功率 [Power]: 9W  
 材质 [Material]: Die casting aluminium+PC

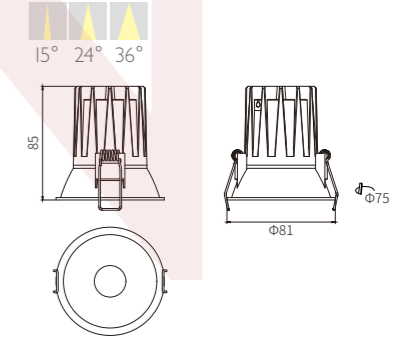

**TSD011-95**

尺寸 [Size]:  $\Phi 100 \times 100 \text{mm}$   
 开孔尺寸 [Cut Hole]:  $\Phi 95 \text{mm}$   
 功率 [Power]: 15W  
 材质 [Material]: Die casting aluminium+PC

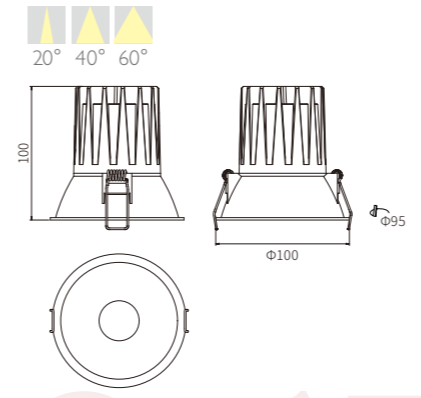

TSD011系列  
TSD011 SERIES

可选颜色/Reflector Colors



芯片/Chip



配件/Accessories



866-186-80577977

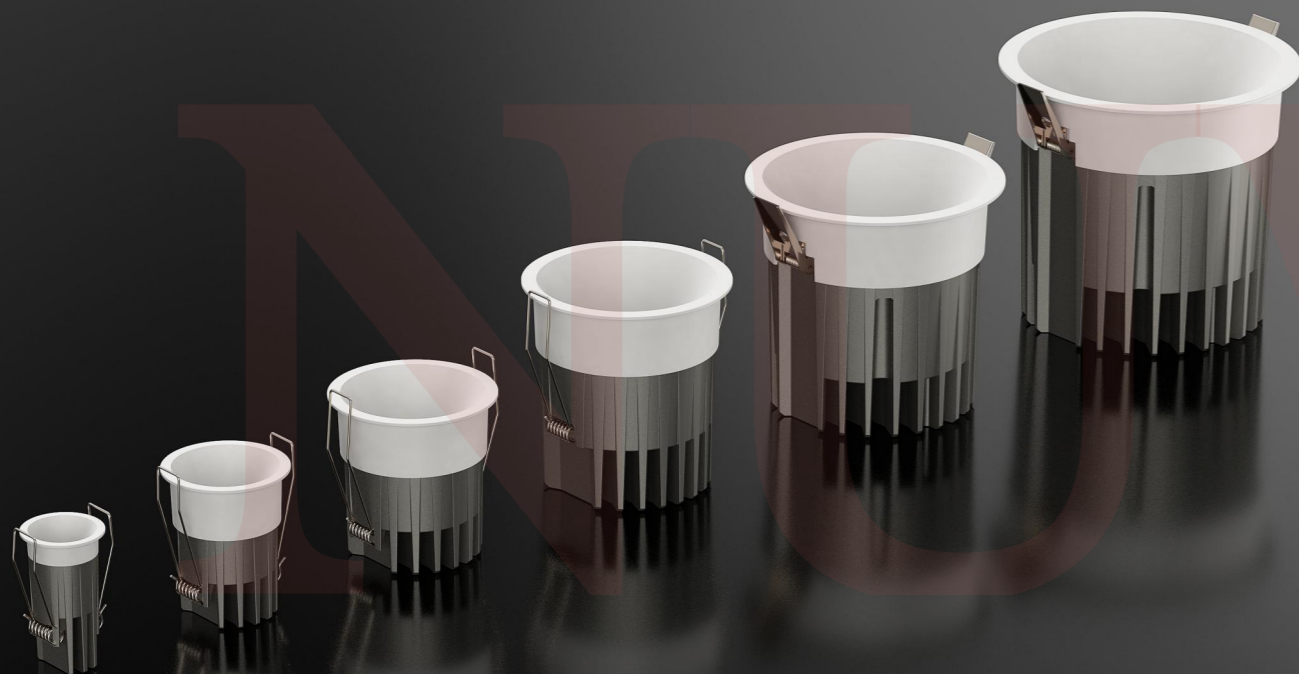

### TD070-35

尺寸 [Size]:  $\Phi 40 \times 68.7 \text{mm}$   
 开孔尺寸 [Cut Hole]:  $\Phi 35 \text{mm}$   
 功率 [Power]: 5W  
 材质 [Material]: Die casting aluminium

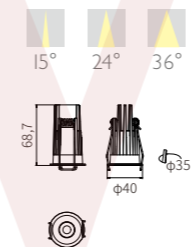

### TD070-55

尺寸 [Size]:  $\Phi 62 \times 75.1 \text{mm}$   
 开孔尺寸 [Cut Hole]:  $\Phi 55 \text{mm}$   
 功率 [Power]: 7W  
 材质 [Material]: Die casting aluminium

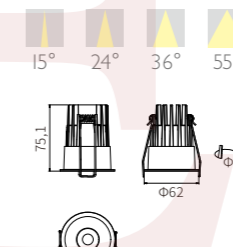

### TD070-75

尺寸 [Size]:  $\Phi 83 \times 83.6 \text{mm}$   
 开孔尺寸 [Cut Hole]:  $\Phi 75 \text{mm}$   
 功率 [Power]: 12W  
 材质 [Material]: Die casting aluminium

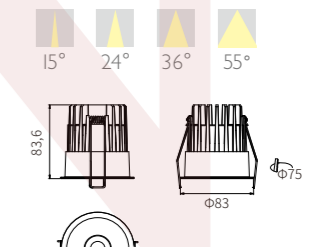

### TD070-95

尺寸 [Size]:  $\Phi 105 \times 108.3 \text{mm}$   
 开孔尺寸 [Cut Hole]:  $\Phi 95 \text{mm}$   
 功率 [Power]: 20W  
 材质 [Material]: Die casting aluminium

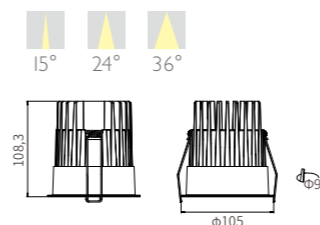

### TD070-120

尺寸 [Size]:  $\Phi 133 \times 122.8 \text{mm}$   
 开孔尺寸 [Cut Hole]:  $\Phi 120 \text{mm}$   
 功率 [Power]: 30W  
 材质 [Material]: Die casting aluminium

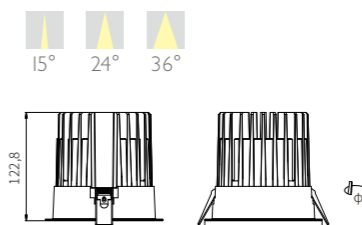

### TD070-145

尺寸 [Size]:  $\Phi 159 \times 142.5 \text{mm}$   
 开孔尺寸 [Cut Hole]:  $\Phi 145 \text{mm}$   
 功率 [Power]: 40W  
 材质 [Material]: Die casting aluminium

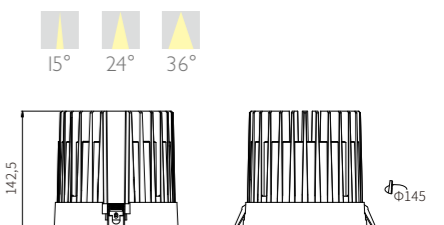

## TD070系列

TD070 SERIES

可选颜色/Reflector Colors



芯片/Chip





**TD071-35**

尺寸 [Size]:  $\Phi 42 \times 56 \text{mm}$   
 开孔尺寸 [Cut Hole]:  $\Phi 35 \text{mm}$   
 功率 [Power]: 3W  
 材质 [Material]: Die casting aluminium

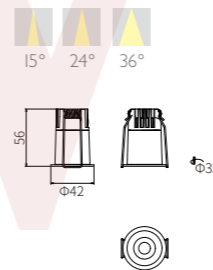

**TD071-45**

尺寸 [Size]:  $\Phi 52 \times 60.5 \text{mm}$   
 开孔尺寸 [Cut Hole]:  $\Phi 45 \text{mm}$   
 功率 [Power]: 5W  
 材质 [Material]: Die casting aluminium

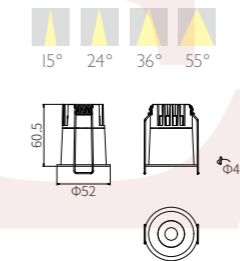

**TD071-55**

尺寸 [Size]:  $\Phi 62 \times 69 \text{mm}$   
 开孔尺寸 [Cut Hole]:  $\Phi 55 \text{mm}$   
 功率 [Power]: 7W  
 材质 [Material]: Die casting aluminium

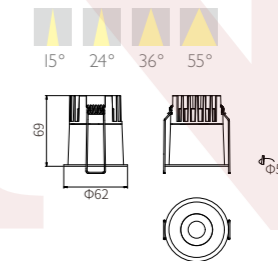

**TD071-65**

尺寸 [Size]:  $\Phi 72 \times 71 \text{mm}$   
 开孔尺寸 [Cut Hole]:  $\Phi 65 \text{mm}$   
 功率 [Power]: 9W  
 材质 [Material]: Die casting aluminium

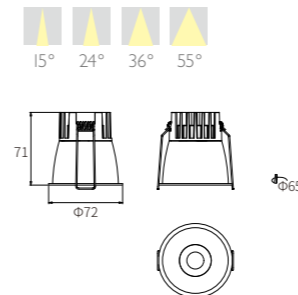

**TD071-75**

尺寸 [Size]:  $\Phi 80 \times 73.5 \text{mm}$   
 开孔尺寸 [Cut Hole]:  $\Phi 75 \text{mm}$   
 功率 [Power]: 12W  
 材质 [Material]: Die casting aluminium

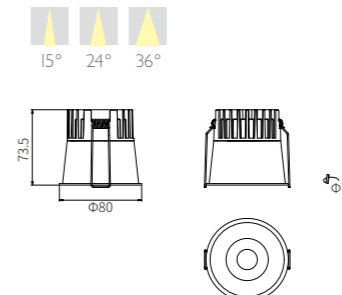

**TD071系列**  
 TD071 Series

防眩罩可选颜色/Reflector Colors



芯片/Chip



COB

# TD072系列

## TD072 Series

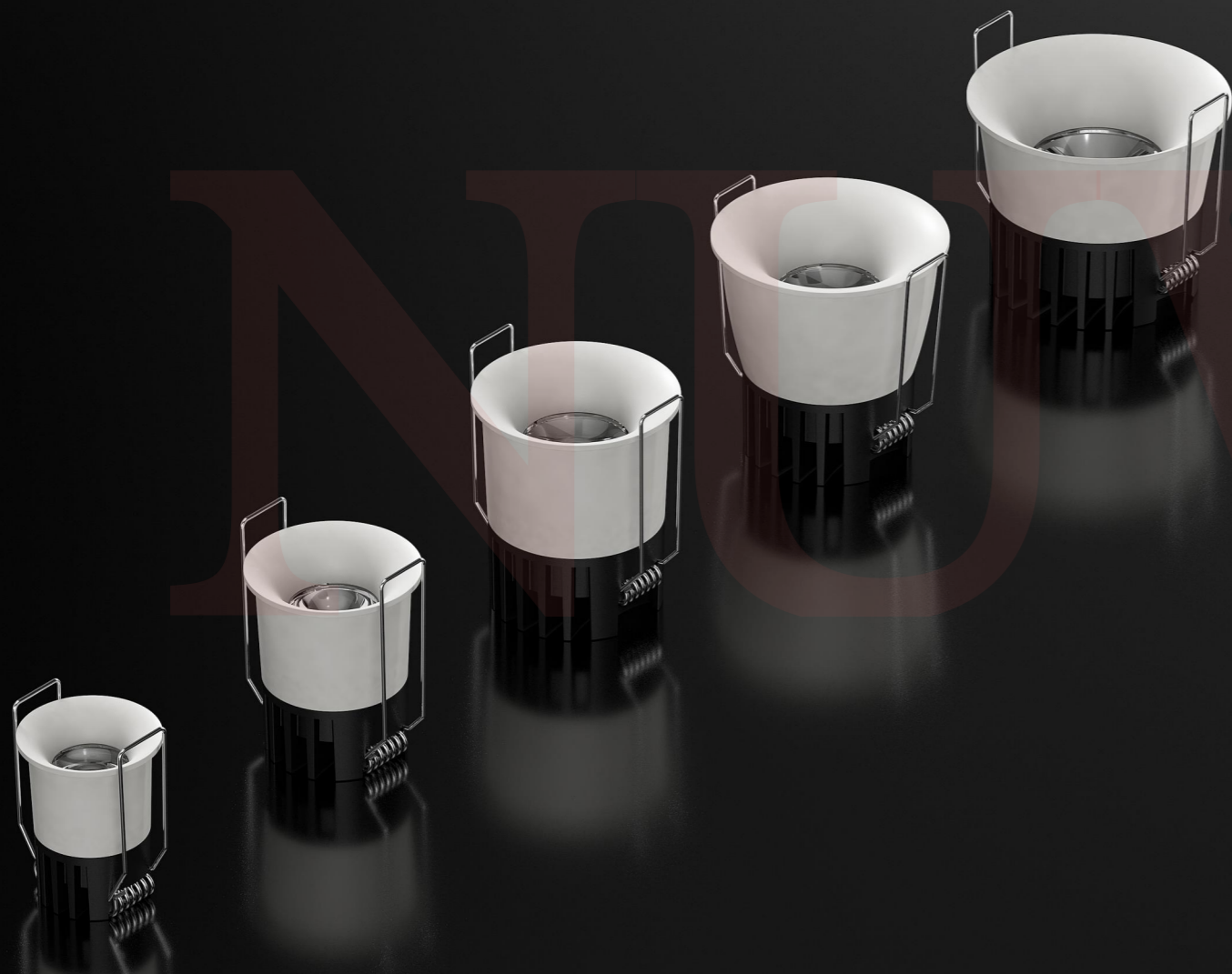

### TD072-35

尺寸 [Size]:  $\Phi 40 \times 51 \text{mm}$   
 开孔尺寸 [Cut Hole]:  $\Phi 35 \text{mm}$   
 功率 [Power]: 3W  
 材质 [Material]: Die casting aluminium

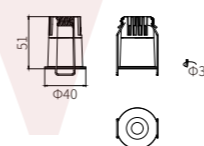

### TD072-45

尺寸 [Size]:  $\Phi 50 \times 58.5 \text{mm}$   
 开孔尺寸 [Cut Hole]:  $\Phi 45 \text{mm}$   
 功率 [Power]: 5W  
 材质 [Material]: Die casting aluminium

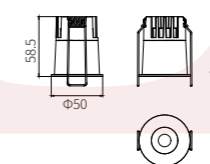

### TD072-55

尺寸 [Size]:  $\Phi 60 \times 68 \text{mm}$   
 开孔尺寸 [Cut Hole]:  $\Phi 55 \text{mm}$   
 功率 [Power]: 7W  
 材质 [Material]: Die casting aluminium

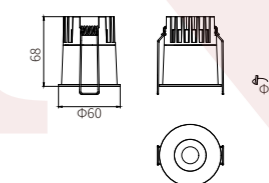
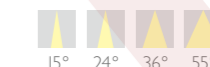

### TD072-65

尺寸 [Size]:  $\Phi 70 \times 71 \text{mm}$   
 开孔尺寸 [Cut Hole]:  $\Phi 65 \text{mm}$   
 功率 [Power]: 9W  
 材质 [Material]: Die casting aluminium

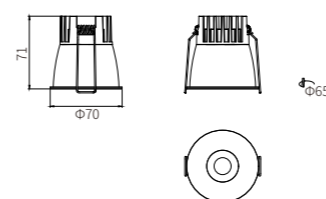

### TD072-75

尺寸 [Size]:  $\Phi 80 \times 63.5 \text{mm}$   
 开孔尺寸 [Cut Hole]:  $\Phi 75 \text{mm}$   
 功率 [Power]: 12W  
 材质 [Material]: Die casting aluminium

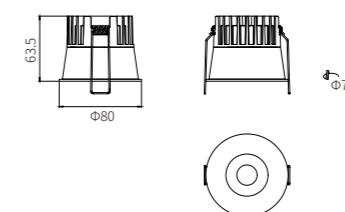

防眩罩可选颜色/Reflector Colors



芯片/Chip



COB

+8666-18680577977

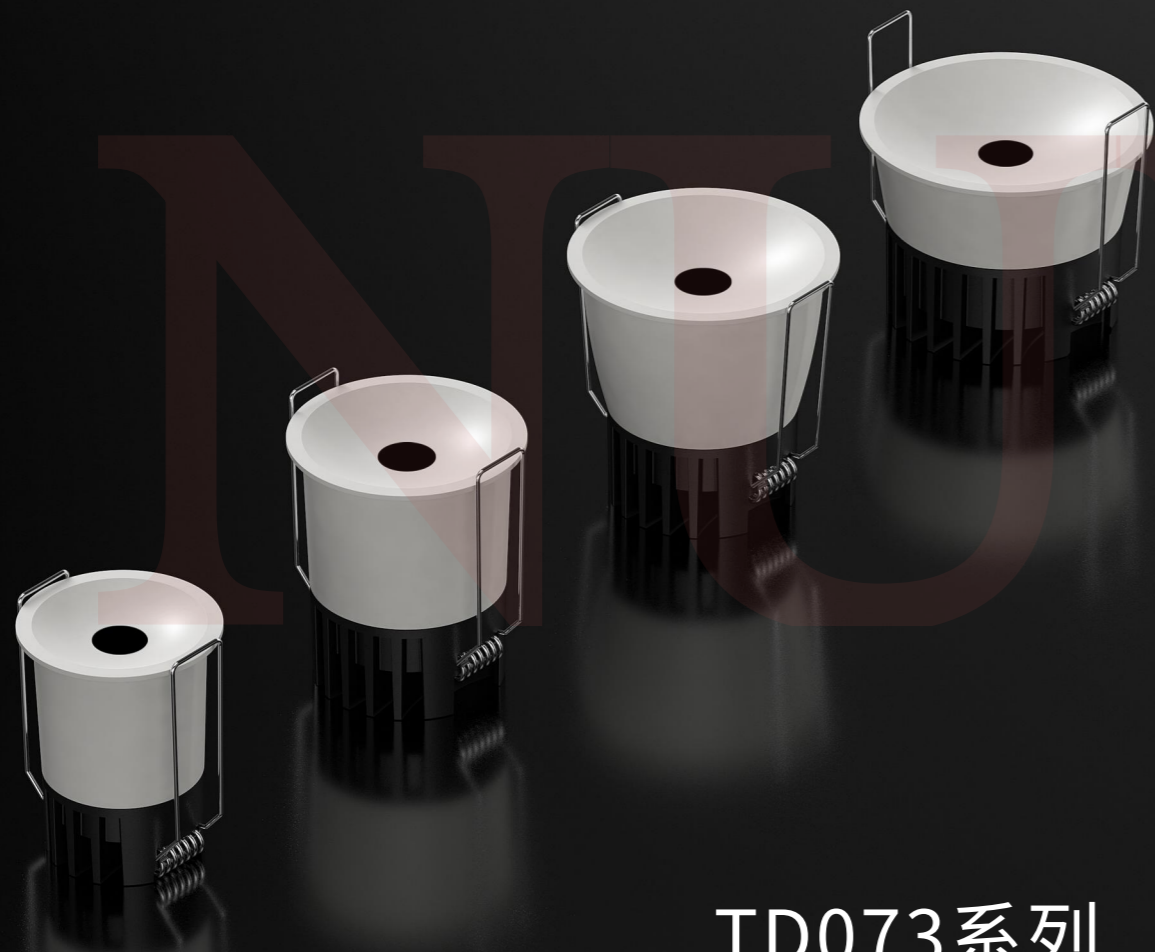

## TD073系列

TD073 Series

### TD073-45

尺寸 [Size]:  $\Phi 52 \times 65.5 \text{mm}$   
 开孔尺寸 [Cut Hole]:  $\Phi 45 \text{mm}$   
 功率 [Power]: 5W  
 材质 [Material]: Die casting aluminium

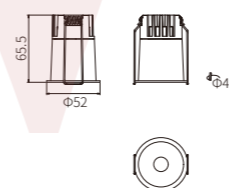

### TD073-55

尺寸 [Size]:  $\Phi 62 \times 71 \text{mm}$   
 开孔尺寸 [Cut Hole]:  $\Phi 55 \text{mm}$   
 功率 [Power]: 7W  
 材质 [Material]: Die casting aluminium

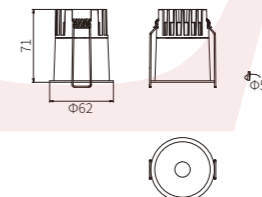

### TD073-65

尺寸 [Size]:  $\Phi 72 \times 73 \text{mm}$   
 开孔尺寸 [Cut Hole]:  $\Phi 65 \text{mm}$   
 功率 [Power]: 9W  
 材质 [Material]: Die casting aluminium

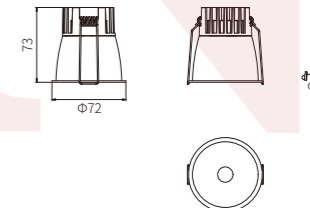

### TD073-75

尺寸 [Size]:  $\Phi 80 \times 58.5 \text{mm}$   
 开孔尺寸 [Cut Hole]:  $\Phi 75 \text{mm}$   
 功率 [Power]: 12W  
 材质 [Material]: Die casting aluminium

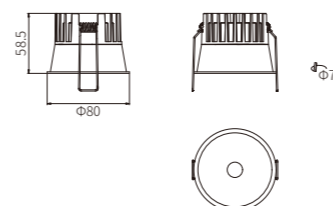

防眩罩可选颜色/Reflector Colors



芯片/Chip



+866-18680577977

# 嫦娥系列

Moon Series

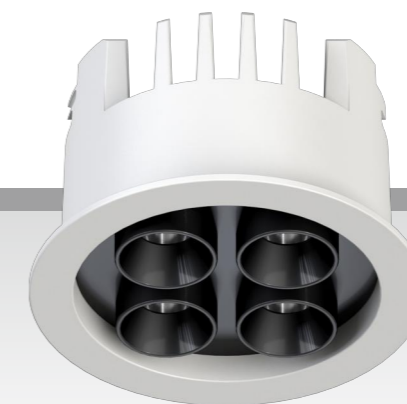

### CE-XTD-R01

尺寸 [Size]:  $\Phi 30 \times 30 \text{mm}$   
 开孔尺寸 [Cut Hole]:  $\Phi 25 \text{mm}$   
 功率 [Power]: 2W  
 材质 [Material]: Die casting aluminium

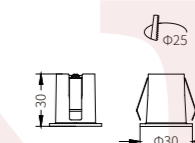

### CE-XTD-S01

尺寸 [Size]:  $30 \times 30 \text{mm}$   
 开孔尺寸 [Cut Hole]:  $\Phi 25 \text{mm}$   
 功率 [Power]: 2W  
 材质 [Material]: Die casting aluminium

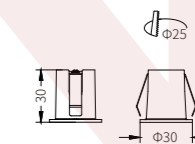

### CE-XTD-R04

尺寸 [Size]:  $\Phi 65 \times 40 \text{mm}$   
 开孔尺寸 [Cut Hole]:  $\Phi 60 \text{mm}$   
 功率 [Power]: 8W  
 材质 [Material]: Die casting aluminium

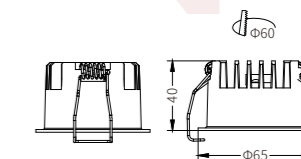

### CE-XTD-S04

尺寸 [Size]:  $52 \times 52 \times 40 \text{mm}$   
 开孔尺寸 [Cut Hole]:  $48 \times 48 \text{mm}$   
 功率 [Power]: 8W  
 材质 [Material]: Die casting aluminium

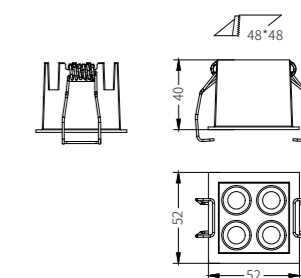

可选光学种类/Optics



可选光学角度/Beam



防眩罩可选颜色/Reflector Colors



芯片/Chip



+866-186-80577977

Trimless



**CE-XTD-B-S03**

尺寸 [Size]: 68.6\*60\*43mm  
 开孔尺寸 [Cut Hole]: 69.5\*37mm  
 功率 [Power]: 6W  
 材质 [Material]: Die casting aluminium

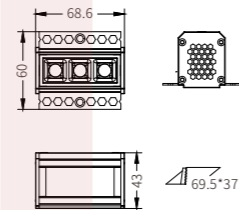

**CE-XTD-S03**

尺寸 [Size]: 69x31x40mm  
 开孔尺寸 [Cut Hole]: 65x27mm  
 功率 [Power]: 6W  
 材质 [Material]: Die casting aluminium

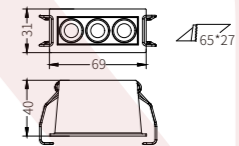

**CE-XTD-B-S06**

尺寸 [Size]: 125.6x60x43mm  
 开孔尺寸 [Cut Hole]: 126.5x37mm  
 功率 [Power]: 10W  
 材质 [Material]: Die casting aluminium

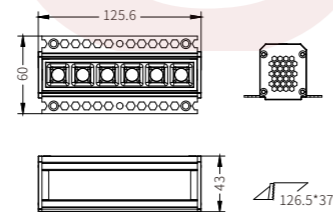

**CE-XTD-S06**

尺寸 [Size]: 126x31x40mm  
 开孔尺寸 [Cut Hole]: 122x27mm  
 功率 [Power]: 10W  
 材质 [Material]: Die casting aluminium

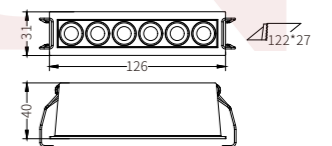

**CE-XTD-B-S12**

尺寸 [Size]: 239.6x60x43mm  
 开孔尺寸 [Cut Hole]: 240.5x37mm  
 功率 [Power]: 20W  
 材质 [Material]: Die casting aluminium

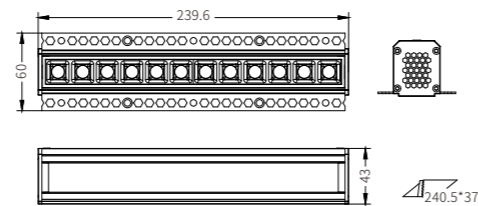

**CE-XTD-S12**

尺寸 [Size]: 240x31x40mm  
 开孔尺寸 [Cut Hole]: 236x27mm  
 功率 [Power]: 20W  
 材质 [Material]: Die casting aluminium

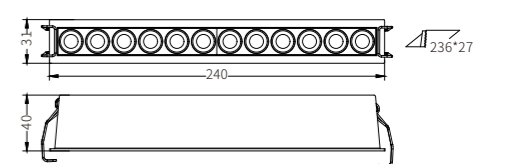

可选光学种类/Optics



可选光学角度/Beam

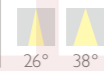

防眩罩可选颜色/Reflector Colors



芯片/Chip

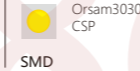

可选光学种类/Optics



可选光学角度/Beam

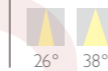

防眩罩可选颜色/Reflector Colors



芯片/Chip



4866 1868 0577977

**CE-GSD-S03**

尺寸 [Size]: 84x49x44mm  
 开孔尺寸 [Cut Hole]: 78x43mm  
 功率 [Power]: 6W  
 材质 [Material]: Die casting aluminium

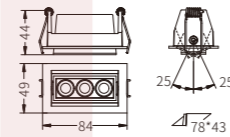
**CE-GSD-S06**

尺寸 [Size]: 141x49x44mm  
 开孔尺寸 [Cut Hole]: 136x43mm  
 功率 [Power]: 10W  
 材质 [Material]: Die casting aluminium

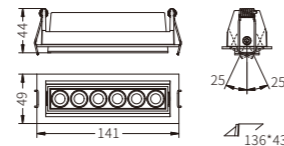
**CE-GSD-S12**

尺寸 [Size]: 255x49x44mm  
 开孔尺寸 [Cut Hole]: 250x43mm  
 功率 [Power]: 20W  
 材质 [Material]: Die casting aluminium

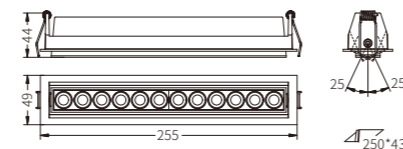

可选光学种类/Optics



凹面防眩罩



凸面防眩罩

可选光学角度/Beam



26°



38°

防眩罩可选颜色/Reflector Colors



黑 B



透明 T

凹面光学



外白内黑 W+B



外白内金 W+G



外黑内金 B+G



全黑 B

凸面光学

芯片/Chip



Orsam3030 CSP

SMD

可选光学种类/Optics



凹面防眩罩



凸面防眩罩

可选光学角度/Beam



26°



38°

防眩罩可选颜色/Reflector Colors



黑 B



透明 T

凹面光学



外白内黑 W+B



外白内金 W+G



外黑内金 B+G



全黑 B

凸面光学

芯片/Chip



Orsam3030 CSP

SMD

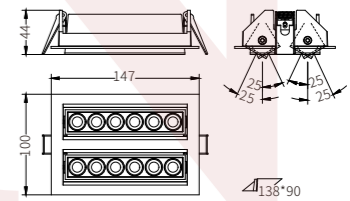
**CE-GSD-S06x2**

尺寸 [Size]: 147x100x44mm  
 开孔尺寸 [Cut Hole]: 138x90mm  
 功率 [Power]: 2x10W  
 材质 [Material]: Die casting aluminium

**CE-GSD-S12x2**

尺寸 [Size]: 261x100x44mm  
 开孔尺寸 [Cut Hole]: 252x90mm  
 功率 [Power]: 2x20W  
 材质 [Material]: Die casting aluminium

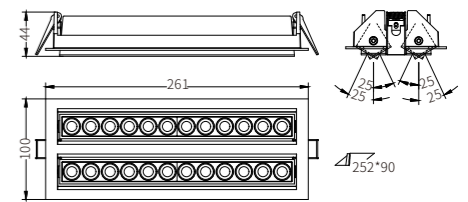



**CE-XTD-WW-S06**

尺寸 [Size]: 112.5x31.5x45mm  
 开孔尺寸 [Cut Hole]: 108x27mm  
 功率 [Power]: 10W  
 材质 [Material]: Die casting aluminium

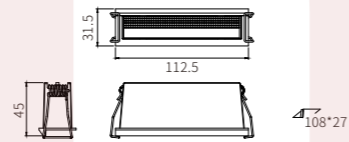

**CE-XTD-WW-S12**

尺寸 [Size]: 212x31.5x45mm  
 开孔尺寸 [Cut Hole]: 207x27mm  
 功率 [Power]: 20W  
 材质 [Material]: Die casting aluminium

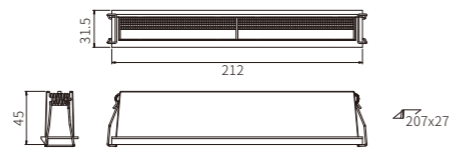

芯片/Chip  
  
 Orsam3030  
 Cree3030  
 平面3030  
 SMD

+8666-18680577977





**CE-GD-R03**

尺寸 [Size]:  $\Phi 47.4 \times 90 \text{mm}$   
 功率 [Power]: 8W  
 材质 [Material]: Aluminium

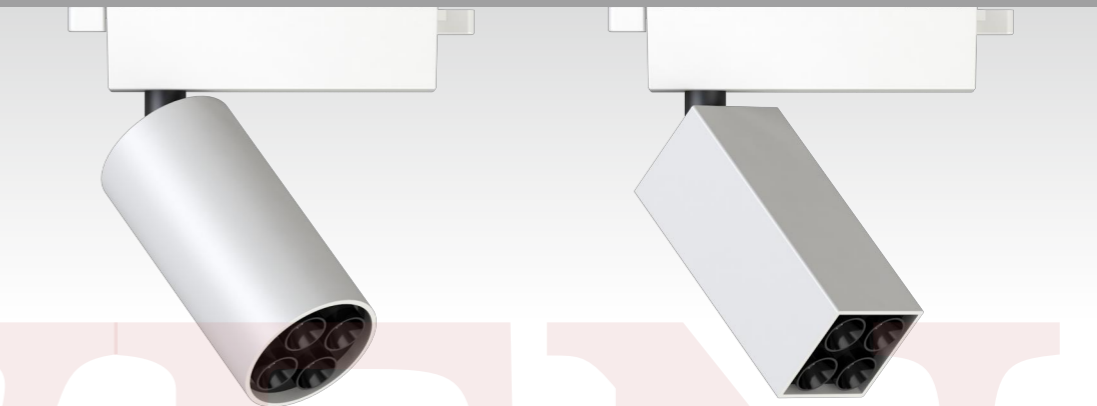
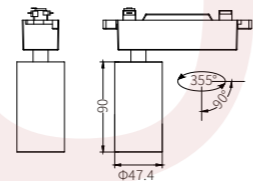

**CE-GD-R04**

尺寸 [Size]:  $\Phi 54.4 \times 105 \text{mm}$   
 功率 [Power]: 10W  
 材质 [Material]: Aluminium

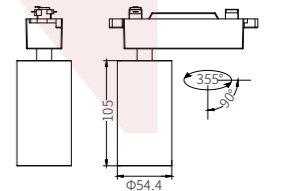

- |                                   |                                   |   |  |   |
|-----------------------------------|-----------------------------------|---|--|---|
| <p>可选光学种类/Optics</p> <p>凸面防眩罩</p> | <p>可选光学角度/Beam</p> <p>26° 38°</p> | <p>可选灯体颜色/Fixture Colors</p> <p>白 W 黑 B 金 G</p> | <p>防眩罩可选颜色/Reflector Colors</p> <p>外白内黑 W+B 外白内金 W+G 外黑内金 B+G 全黑 B</p> | <p>芯片/Chip</p> <p>SMD Orsam3030 CSP</p> |
|-----------------------------------|-----------------------------------|---|--|---|



**CE-C48-GD**

尺寸 [Size]:  $\Phi 47.4 \times 90 \text{mm}$   
 功率 [Power]: 8W  
 材质 [Material]: Aluminium

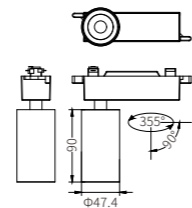

**CE-GD-S04**

尺寸 [Size]:  $44 \times 44 \times 105 \text{mm}$   
 功率 [Power]: 10W  
 材质 [Material]: Aluminium

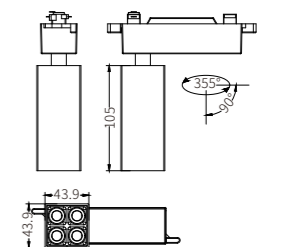

- |   |   |   |  |                                   |                                   |   |  |   |
|---|---|---|--|-----------------------------------|-----------------------------------|---|--|---|
| <p>可选光学角度/Beam</p> <p>15° 24° 36° 60°</p> | <p>可选灯体颜色/Fixture Colors</p> <p>白 W 黑 B 金 G</p> | <p>防眩罩可选颜色/Reflector Colors</p> <p>白色 W 黑色 B 金色 G</p> | <p>芯片/Chip</p> <p>COB CREE CITIZEN</p> | <p>可选光学种类/Optics</p> <p>凸面防眩罩</p> | <p>可选光学角度/Beam</p> <p>26° 38°</p> | <p>可选灯体颜色/Fixture Colors</p> <p>白 W 黑 B 金 G</p> | <p>防眩罩可选颜色/Reflector Colors</p> <p>外白内黑 W+B 外白内金 W+G 外黑内金 B+G 全黑 B</p> | <p>芯片/Chip</p> <p>SMD Orsam3030 CSP</p> |
|---|---|---|--|-----------------------------------|-----------------------------------|---|--|---|

1866-18680577977

**CE-RI-R-01**

尺寸 [Size]:  $\Phi 53 \times 177.6 \text{mm}$  ( $\Phi 23 \times 138 \text{mm}$ )  
 开孔尺寸 [Cut Hole]:  $\Phi 45 \text{mm}$   
 功率 [Power]: 5W  
 材质 [Material]: Aluminium

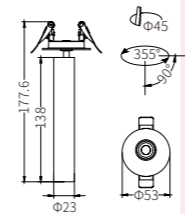
**CE-RI-R-02**

尺寸 [Size]:  $\Phi 75 \times 177.6 \text{mm}$  ( $\Phi 23 \times 138 \text{mm}$ )  
 开孔尺寸 [Cut Hole]:  $\Phi 65 \text{mm}$   
 功率 [Power]: 2x5W  
 材质 [Material]: Aluminium

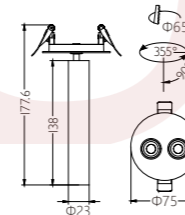
**CE-RI-S-01**

尺寸 [Size]:  $60 \times 60 \times 177.8 \text{mm}$  ( $\Phi 23 \times 138 \text{mm}$ )  
 开孔尺寸 [Cut Hole]:  $55 \times 55 \text{mm}$   
 功率 [Power]: 5W  
 材质 [Material]: Aluminium

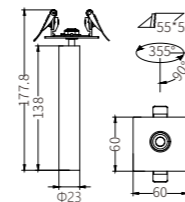
**CE-RI-S-02**

尺寸 [Size]:  $150 \times 60 \times 177.8 \text{mm}$  ( $\Phi 23 \times 138 \text{mm}$ )  
 开孔尺寸 [Cut Hole]:  $140 \times 50 \text{mm}$   
 功率 [Power]: 2x5W  
 材质 [Material]: Aluminium

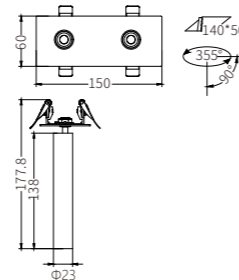
**CE-RI-S-03**

尺寸 [Size]:  $265 \times 60 \times 177.8 \text{mm}$   
 ( $\Phi 23 \times 138 \text{mm}$ )  
 开孔尺寸 [Cut Hole]:  $255 \times 50 \text{mm}$   
 功率 [Power]: 3x5W  
 材质 [Material]: Aluminium

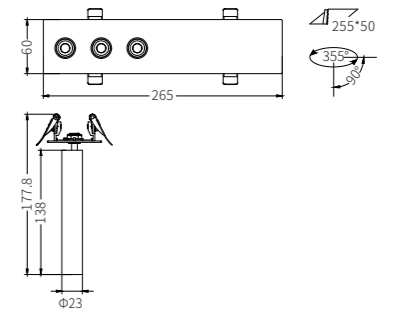
**CE-RI-M-01**

尺寸 [Size]:  $220 \times 60 \times 183.6 \text{mm}$   
 ( $\Phi 23 \times 138 \text{mm}$ )  
 功率 [Power]: 5W  
 材质 [Material]: Aluminium

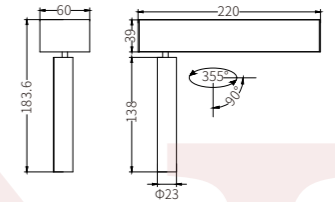
**CE-RI-M-02**

尺寸 [Size]:  $250 \times 60 \times 183.6 \text{mm}$   
 ( $\Phi 23 \times 138 \text{mm}$ )  
 功率 [Power]: 2x5W  
 材质 [Material]: Aluminium

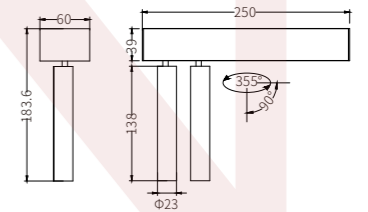
**CE-RI-M-03**

尺寸 [Size]:  $300 \times 60 \times 183.6 \text{mm}$   
 ( $\Phi 23 \times 138 \text{mm}$ )  
 功率 [Power]: 3x5W  
 材质 [Material]: Aluminium

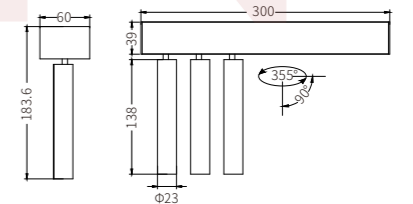
**CE-R01-LS-A**

尺寸 [Size]:  $\Phi 62 \times 251.5 \text{mm}$   
 开孔尺寸 [Cut Hole]:  $\Phi 55 \text{mm}$   
 功率 [Power]: 5W  
 材质 [Material]: Aluminium

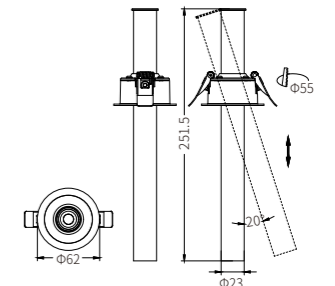

可选光学种类/Optics



凹面防眩罩

可选光学角度/Beam

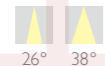

26° 38°

可选灯体颜色/Fixture Colors



白 W 黑 B 金 G

防眩罩可选颜色/Reflector Colors



黑 B 透明 T

芯片/Chip



SMD

可选光学种类/Optics



凹面防眩罩

可选光学角度/Beam

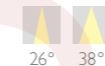

26° 38°

可选灯体颜色/Fixture Colors



白 W 黑 B 金 G

防眩罩可选颜色/Reflector Colors



黑 B 透明 T

芯片/Chip



SMD



**CE-C48-R-01**

尺寸 [Size]:  $\Phi 53 \times 132.7 \text{mm}$  ( $\Phi 47.4 \times 90 \text{mm}$ )  
 开孔尺寸 [Cut Hole]:  $\Phi 45 \text{mm}$   
 功率 [Power]: 8W  
 材质 [Material]: Aluminium

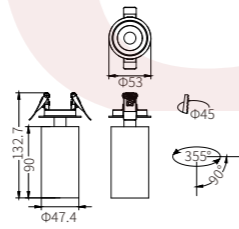

**CE-C48-S-01**

尺寸 [Size]:  $60 \times 60 \times 132.7 \text{mm}$  ( $\Phi 47.4 \times 90 \text{mm}$ )  
 开孔尺寸 [Cut Hole]:  $50 \times 50 \text{mm}$   
 功率 [Power]: 8W  
 材质 [Material]: Aluminium

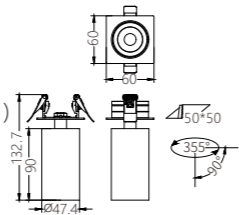

可选光学角度/Beam

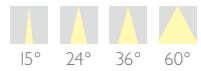

可选灯体颜色/Fixture Colors



防眩罩可选颜色/Reflector Colors



芯片/Chip

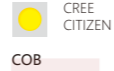

**CE-C48-S-02**

尺寸 [Size]:  $300 \times 60 \times 132.7 \text{mm}$   
 ( $\Phi 47.4 \times 90 \text{mm}$ )  
 开孔尺寸 [Cut Hole]:  $290 \times 50 \text{mm}$   
 功率 [Power]:  $2 \times 8 \text{W}$   
 材质 [Material]: Aluminium

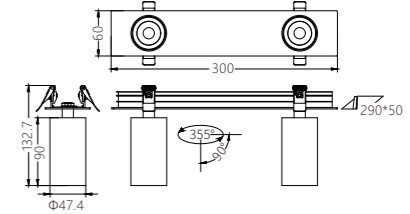

**CE-C48-S-03**

尺寸 [Size]:  $400 \times 60 \times 132.7 \text{mm}$   
 ( $\Phi 47.4 \times 90 \text{mm}$ )  
 开孔尺寸 [Cut Hole]:  $390 \times 50 \text{mm}$   
 功率 [Power]:  $3 \times 8 \text{W}$   
 材质 [Material]: Aluminium

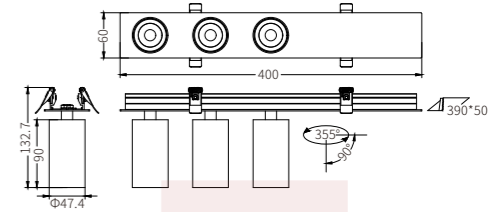

**CE-C48-M-01**

尺寸 [Size]:  $220 \times 60 \times 138.7 \text{mm}$   
 ( $\Phi 47.4 \times 90 \text{mm}$ )  
 功率 [Power]: 8W  
 材质 [Material]: Aluminium

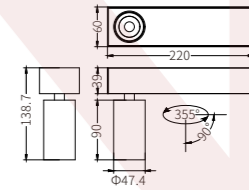

**CE-C48-M-02**

尺寸 [Size]:  $300 \times 60 \times 138.7 \text{mm}$   
 ( $\Phi 47.4 \times 90 \text{mm}$ )  
 功率 [Power]:  $2 \times 8 \text{W}$   
 材质 [Material]: Aluminium

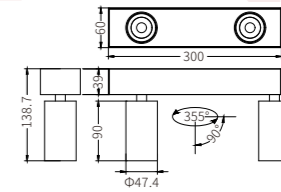

**CE-C48-M-03**

尺寸 [Size]:  $400 \times 60 \times 138.7 \text{mm}$   
 ( $\Phi 47.4 \times 90 \text{mm}$ )  
 功率 [Power]:  $3 \times 8 \text{W}$   
 材质 [Material]: Aluminium

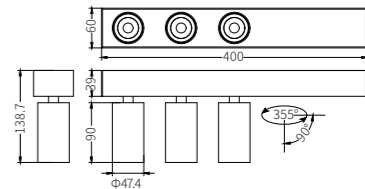

可选光学角度/Beam

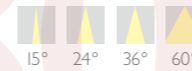

可选灯体颜色/Fixture Colors



防眩罩可选颜色/Reflector Colors



芯片/Chip



1866-18680577977



### CE-R3-R-01

尺寸 [Size]:  $\Phi 53 \times 132.7 \text{mm}$  ( $\Phi 47.4 \times 90 \text{mm}$ )  
 开孔尺寸 [Cut Hole]:  $\Phi 45 \text{mm}$   
 功率 [Power]: 8W  
 材质 [Material]: Aluminium

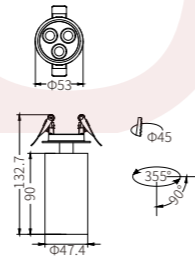

### CE-R3-S-01

尺寸 [Size]:  $60 \times 60 \times 132.7 \text{mm}$  ( $\Phi 47.4 \times 90 \text{mm}$ )  
 开孔尺寸 [Cut Hole]:  $50 \times 50 \text{mm}$   
 功率 [Power]: 8W  
 材质 [Material]: Aluminium

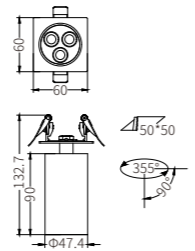

### CE-R3-S-02

尺寸 [Size]:  $300 \times 60 \times 132.7 \text{mm}$   
 ( $\Phi 47.4 \times 90 \text{mm}$ )  
 开孔尺寸 [Cut Hole]:  $290 \times 50 \text{mm}$   
 功率 [Power]:  $2 \times 8 \text{W}$   
 材质 [Material]: Aluminium

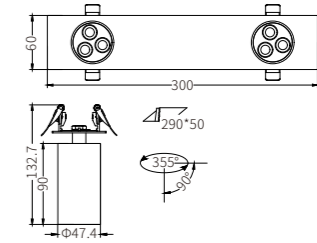

### CE-R3-S-03

尺寸 [Size]:  $400 \times 60 \times 132.7 \text{mm}$   
 ( $\Phi 47.4 \times 90 \text{mm}$ )  
 开孔尺寸 [Cut Hole]:  $390 \times 50 \text{mm}$   
 功率 [Power]:  $3 \times 8 \text{W}$   
 材质 [Material]: Aluminium

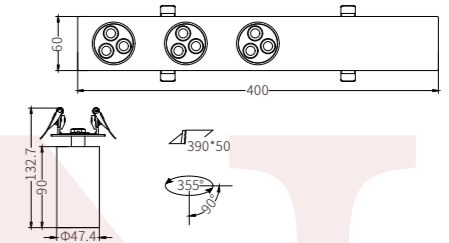

### CE-R3-M-01

尺寸 [Size]:  $220 \times 60 \times 138.7 \text{mm}$   
 ( $\Phi 47.4 \times 90 \text{mm}$ )  
 功率 [Power]: 8W  
 材质 [Material]: Aluminium

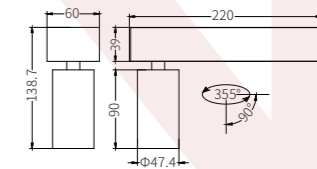

### CE-R3-M-02

尺寸 [Size]:  $300 \times 60 \times 138.7 \text{mm}$   
 ( $\Phi 47.4 \times 90 \text{mm}$ )  
 功率 [Power]:  $2 \times 8 \text{W}$   
 材质 [Material]: Aluminium

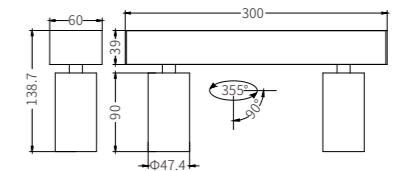

### CE-R3-M-03

尺寸 [Size]:  $400 \times 60 \times 138.7 \text{mm}$   
 ( $\Phi 47.4 \times 90 \text{mm}$ )  
 功率 [Power]:  $3 \times 8 \text{W}$   
 材质 [Material]: Aluminium

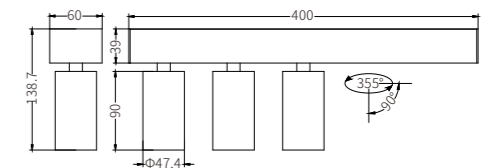

可选光学种类/Optics



凸面防眩罩

可选光学角度/Beam

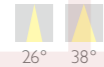

26° 38°

可选灯体颜色/Fixture Colors



白 W 黑 B 金 G

防眩罩可选颜色/Reflector Colors



外白内黑 W+B 外白内金 W+G 外黑内金 B+G 全黑 B

芯片/Chip



Orsam3030 CSP SMD

可选光学种类/Optics



凸面防眩罩

可选光学角度/Beam

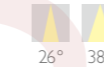

26° 38°

可选灯体颜色/Fixture Colors



白 W 黑 B 金 G

防眩罩可选颜色/Reflector Colors



外白内黑 W+B 外白内金 W+G 外黑内金 B+G 全黑 B

芯片/Chip



Orsam3030 CSP SMD



#### CE-R4-R-01

尺寸 [Size]:  $\Phi 53 \times 147.7 \text{mm}$  ( $\Phi 54.4 \times 105 \text{mm}$ )  
 开孔尺寸 [Cut Hole]:  $\Phi 45 \text{mm}$   
 功率 [Power]: 10W  
 材质 [Material]: Aluminium

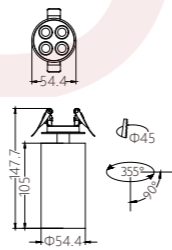

#### CE-R4-S-01

尺寸 [Size]:  $60 \times 60 \times 147.7 \text{mm}$  ( $\Phi 54.4 \times 105 \text{mm}$ )  
 开孔尺寸 [Cut Hole]:  $50 \times 50 \text{mm}$   
 功率 [Power]: 10W  
 材质 [Material]: Aluminium

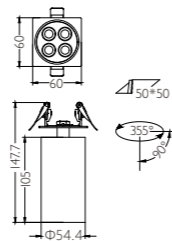

#### CE-R4-S-02

尺寸 [Size]:  $300 \times 60 \times 147.7 \text{mm}$   
 ( $\Phi 54.4 \times 105 \text{mm}$ )  
 开孔尺寸 [Cut Hole]:  $290 \times 50 \text{mm}$   
 功率 [Power]:  $2 \times 10 \text{W}$   
 材质 [Material]: Aluminium

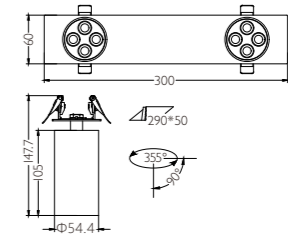

#### CE-R4-S-03

尺寸 [Size]:  $400 \times 60 \times 147.7 \text{mm}$   
 ( $\Phi 54.4 \times 105 \text{mm}$ )  
 开孔尺寸 [Cut Hole]:  $390 \times 50 \text{mm}$   
 功率 [Power]:  $3 \times 10 \text{W}$   
 材质 [Material]: Aluminium

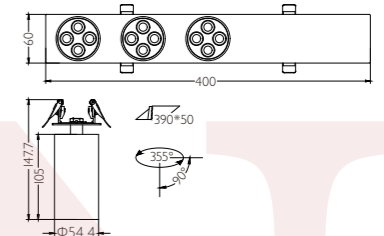

#### CE-R4-M-01

尺寸 [Size]:  $220 \times 60 \times 153.7 \text{mm}$   
 ( $\Phi 54.4 \times 105 \text{mm}$ )  
 功率 [Power]: 10W  
 材质 [Material]: Aluminium

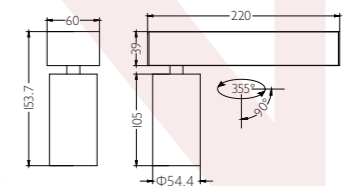

#### CE-R4-M-02

尺寸 [Size]:  $300 \times 60 \times 153.7 \text{mm}$   
 ( $\Phi 54.4 \times 105 \text{mm}$ )  
 功率 [Power]:  $2 \times 10 \text{W}$   
 材质 [Material]: Aluminium

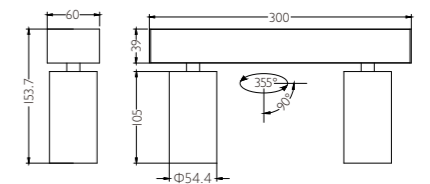

#### CE-R4-M-03

尺寸 [Size]:  $400 \times 60 \times 153.7 \text{mm}$   
 ( $\Phi 54.4 \times 105 \text{mm}$ )  
 功率 [Power]:  $3 \times 10 \text{W}$   
 材质 [Material]: Aluminium

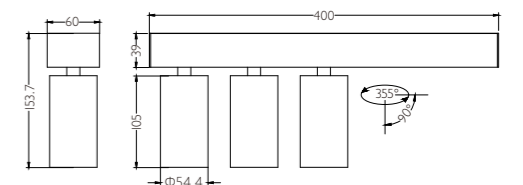

可选光学种类/Optics



凸面防眩罩

可选光学角度/Beam

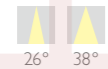

26° 38°

可选灯体颜色/Fixture Colors



白 W 黑 B 金 G

防眩罩可选颜色/Reflector Colors



外白内黑 W+B 外白内金 W+G 外黑内金 B+G 全黑 B

芯片/Chip



Orsam3030 CSP SMD

可选光学种类/Optics



凸面防眩罩

可选光学角度/Beam

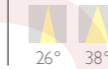

26° 38°

可选灯体颜色/Fixture Colors

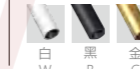

白 W 黑 B 金 G

防眩罩可选颜色/Reflector Colors



外白内黑 W+B 外白内金 W+G 外黑内金 B+G 全黑 B

芯片/Chip



Orsam3030 CSP SMD

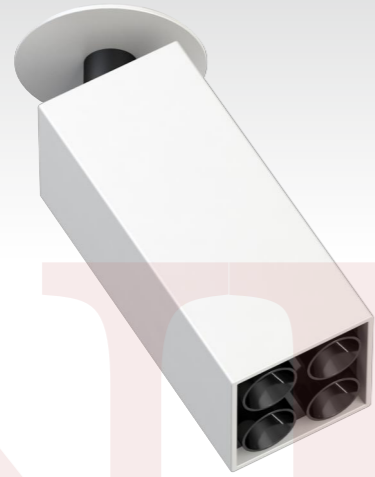

### CE-S4-R-01

尺寸 [Size]:  $\Phi 53 \times 147.7 \text{mm}$   
(44x44x105mm)  
开孔尺寸 [Cut Hole]:  $\Phi 45 \text{mm}$   
功率 [Power]: 10W  
材质 [Material]: Aluminium

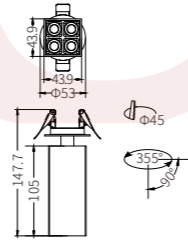

### CE-S4-S-01

尺寸 [Size]:  $60 \times 60 \times 147.7 \text{mm}$   
(44x44x105mm)  
开孔尺寸 [Cut Hole]:  $50 \times 50 \text{mm}$   
功率 [Power]: 10W  
材质 [Material]: Aluminium

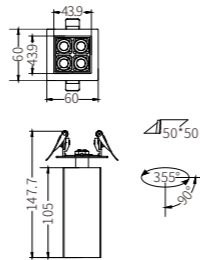

可选光学种类/Optics



可选光学角度/Beam



可选灯体颜色/Fixture Colors



防眩罩可选颜色/Reflector Colors



芯片/Chip



可选光学种类/Optics



可选光学角度/Beam



可选灯体颜色/Fixture Colors



防眩罩可选颜色/Reflector Colors



芯片/Chip



### CE-S4-S-02

尺寸 [Size]:  $300 \times 60 \times 147.7 \text{mm}$   
(44x44x105mm)  
开孔尺寸 [Cut Hole]:  $290 \times 50 \text{mm}$   
功率 [Power]: 2x10W  
材质 [Material]: Aluminium

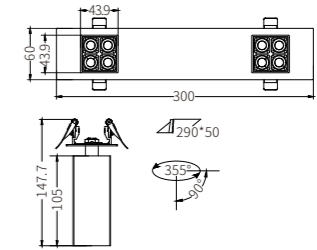

### CE-S4-S-03

尺寸 [Size]:  $400 \times 60 \times 147.7 \text{mm}$   
(44x44x105mm)  
开孔尺寸 [Cut Hole]:  $390 \times 50 \text{mm}$   
功率 [Power]: 3x10W  
材质 [Material]: Aluminium

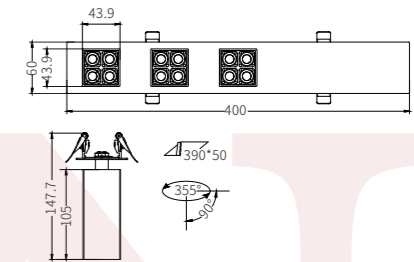

### CE-S4-M-01

尺寸 [Size]:  $220 \times 60 \times 153.7 \text{mm}$   
(44x44x105mm)  
功率 [Power]: 10W  
材质 [Material]: Aluminium

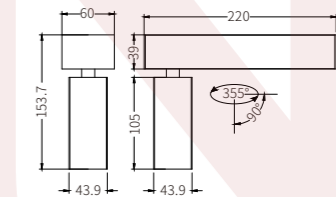

### CE-S4-M-02

尺寸 [Size]:  $300 \times 60 \times 153.7 \text{mm}$   
(44x44x105mm)  
功率 [Power]: 2x10W  
材质 [Material]: Aluminium

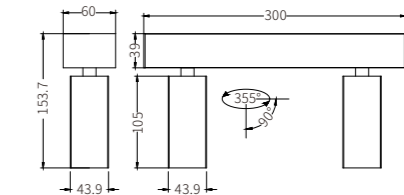

### CE-S4-M-03

尺寸 [Size]:  $400 \times 60 \times 153.7 \text{mm}$   
(44x44x105mm)  
功率 [Power]: 3x10W  
材质 [Material]: Aluminium

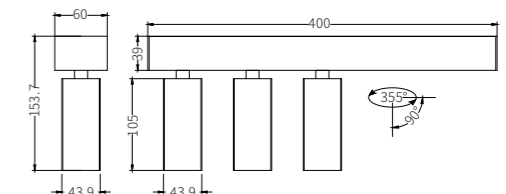



#### CE-WX-R03-A

尺寸 [Size]:  $\Phi 105 \times 108.8 \text{mm} (\Phi 54.4 \times 76.4 \text{mm})$   
 开孔尺寸 [Cut Hole]:  $\Phi 95 \text{mm}$   
 功率 [Power]: 8W  
 材质 [Material]: Aluminium

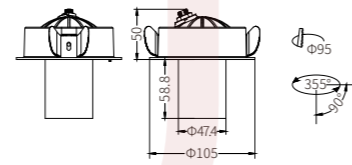

#### CE-WX-R04-A

尺寸 [Size]:  $\Phi 105 \times 126.4 \text{mm} (\Phi 54.4 \times 76.4 \text{mm})$   
 开孔尺寸 [Cut Hole]:  $\Phi 95 \text{mm}$   
 功率 [Power]: 10W  
 材质 [Material]: Aluminium

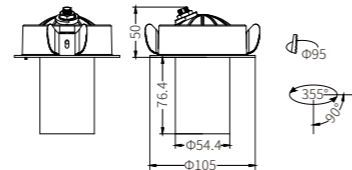

#### CE-LM-R03-SD

尺寸 [Size]:  $\Phi 47.4 \times 263.7 \text{mm}$   
 功率 [Power]: 8W  
 材质 [Material]: Aluminium

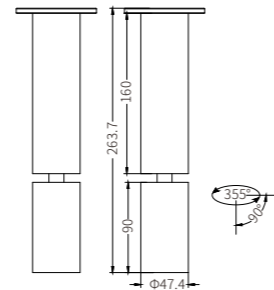

可选光学种类/Optics



凸面防眩罩

可选光学角度/Beam



26° 38°

可选灯体颜色/Fixture Colors



白 W 黑 B 金 G

防眩罩可选颜色/Reflector Colors



外白内黑 W+B 外白内金 W+G 外黑内金 B+G 全黑 B

芯片/Chip



SMD

可选光学种类/Optics



凸面防眩罩

可选光学角度/Beam



26° 38°

可选灯体颜色/Fixture Colors



白 W 黑 B 金 G

防眩罩可选颜色/Reflector Colors



外白内黑 W+B 外白内金 W+G 外黑内金 B+G 全黑 B

芯片/Chip



SMD



#### CE-LM-S04

尺寸 [Size]:  $44 \times 44 \times 220 \text{mm}$   
 功率 [Power]: 15W  
 材质 [Material]: Aluminium

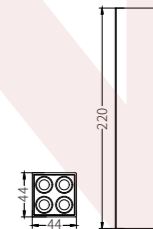

#### CE-LM-R04

尺寸 [Size]:  $\Phi 54.4 \times 220 \text{mm}$   
 功率 [Power]: 15W  
 材质 [Material]: Aluminium

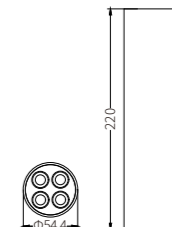

#### CE-LM-R03

尺寸 [Size]:  $\Phi 47.4 \times 220 \text{mm}$   
 功率 [Power]: 15W  
 材质 [Material]: Aluminium

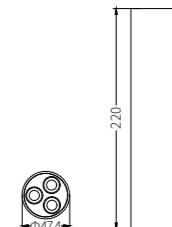



磁吸20系列  
CX20 Series

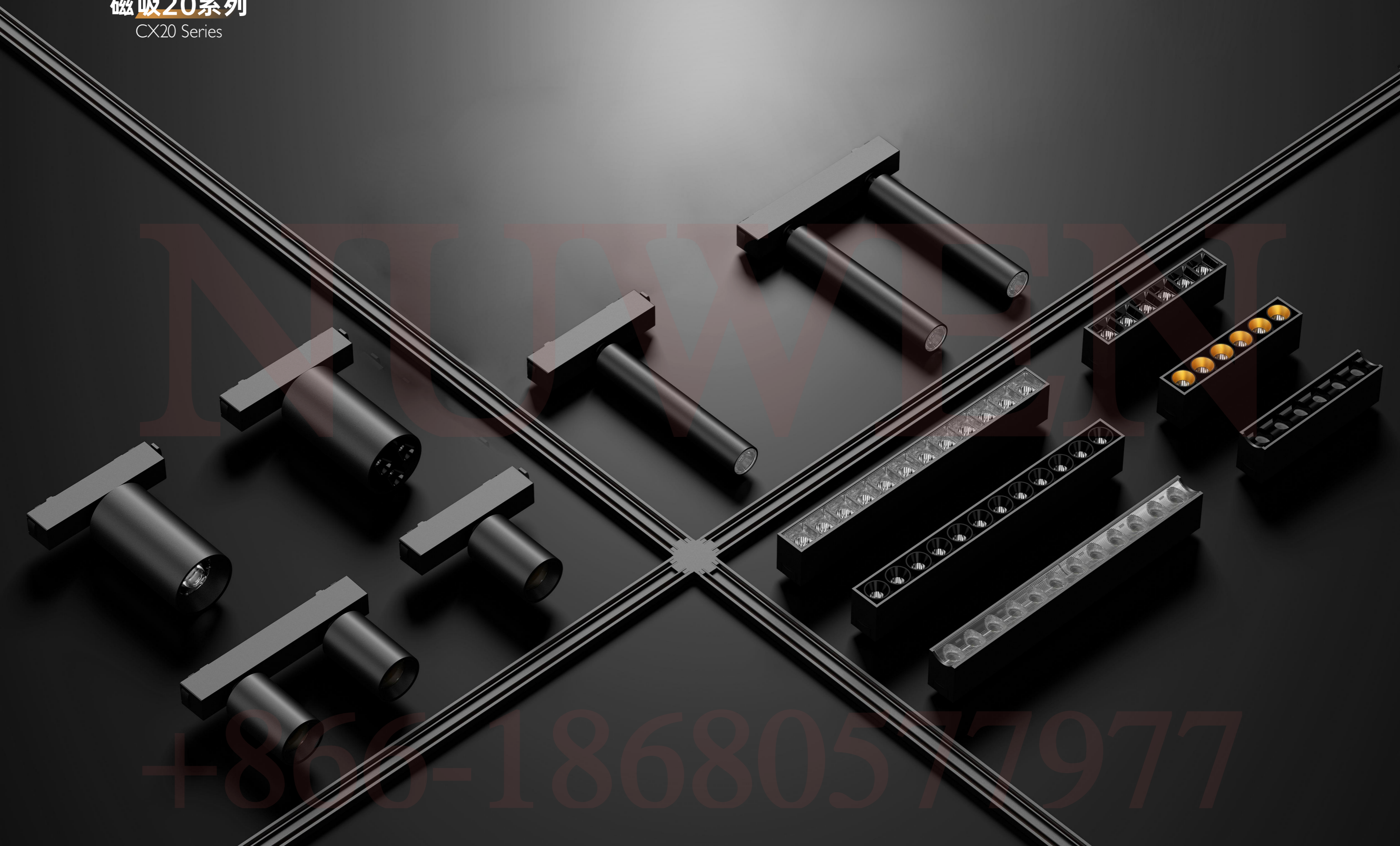

+8660-18680577977



**CX20-GD-R01**

尺寸 [Size]: 100x20x168.3mm  
(Φ23x138mm)  
功率 [Power]: 8W  
材质 [Material]: Aluminium

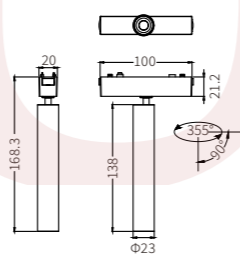

**CX20-GD-C35**

尺寸 [Size]: 100x20x85.7mm  
(Φ35x55mm)  
功率 [Power]: 5W  
材质 [Material]: Aluminium

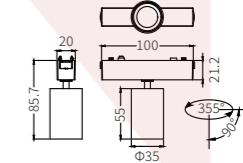

**CX20-GD-R01x2**

尺寸 [Size]: 140x20x168.3mm  
(Φ23x138mm)  
功率 [Power]: 2x8W  
材质 [Material]: Aluminium

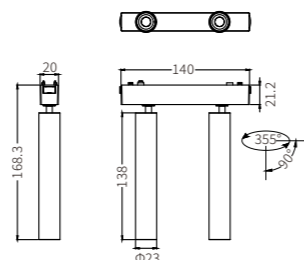

**CX20-GD-C35x2**

尺寸 [Size]: 140x20x85.7mm  
(Φ35x55mm)  
功率 [Power]: 2x5W  
材质 [Material]: Aluminium

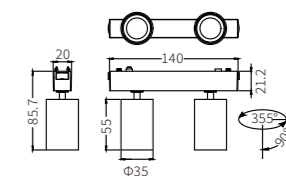

可选光学种类/Optics



凹面防眩罩

可选光学角度/Beam

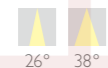

26° 38°

可选灯体颜色/Fixture Colors



白 W 黑 B 金 G

防眩罩可选颜色/Reflector Colors



黑 B 透明 T

芯片/Chip



Orsam3030 CSP SMD

可选光学角度/Beam

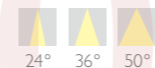

24° 36° 50°

可选灯体颜色/Fixture Colors



白 W 黑 B 金 G

防眩罩可选颜色/Reflector Colors



外白内金 W+G 外黑内金 B+G 全黑 B

芯片/Chip



CREE CITIZEN COB

4866-18680577977



### CX20-GD-C48

尺寸 [Size]: 100x20x122.9mm  
(Φ47.4x90mm)  
功率 [Power]: 8W  
材质 [Material]: Aluminium

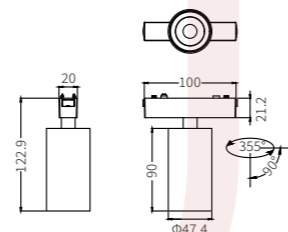

#### 可选光学角度/Beam

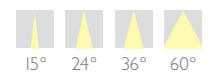

#### 可选灯体颜色/Fixture Colors

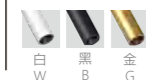

#### 防眩罩可选颜色/Reflector Colors



#### 芯片/Chip



### CX20-GD-R03

尺寸 [Size]: 100x20x122.9mm  
(Φ47.4x122.9mm)  
功率 [Power]: 8W  
材质 [Material]: Aluminium

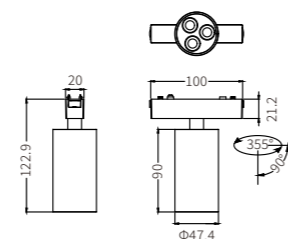

#### 可选光学种类/Optics



#### 可选光学角度/Beam

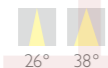

#### 可选灯体颜色/Fixture Colors



#### 防眩罩可选颜色/Reflector Colors



#### 芯片/Chip



#### 可选颜色种类 /Reflector Colors



#### 可选光学角度/Beam



#### 芯片/Chip



### CX20-XTD-GS-06

尺寸 [Size]: 118.1x23.3x32.9mm  
功率 [Power]: 10W  
材质 [Material]: Aluminium

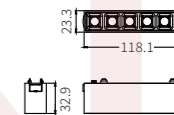

### CX20-XTD-GS-12

尺寸 [Size]: 232.2x23.3x32.9mm  
功率 [Power]: 20W  
材质 [Material]: Aluminium

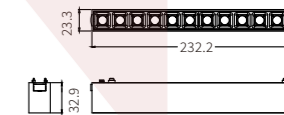

### CX20-XTD-XZ-06

尺寸 [Size]: 118.1x23.3x32.9mm  
功率 [Power]: 10W  
材质 [Material]: Aluminium

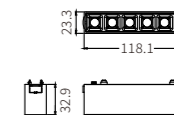

### CX20-XTD-XZ-12

尺寸 [Size]: 232.2x23.3x32.9mm  
功率 [Power]: 20W  
材质 [Material]: Aluminium

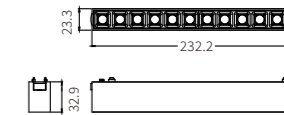

486618680577977



**CX20-C-I**  
尺寸 [Size]: 36x20x6.3mm  
材质 [Material]: PC

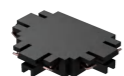
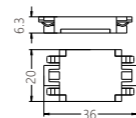

**CX20-C-T**  
尺寸 [Size]: 36x28x6.3mm  
材质 [Material]: PC

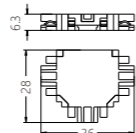

**CX20-C-X**  
尺寸 [Size]: 36x36x6.3mm  
材质 [Material]: PC

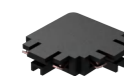
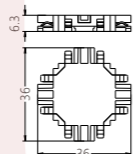

**CX20-C-C**  
尺寸 [Size]: 28x28x6.3mm  
材质 [Material]: PC

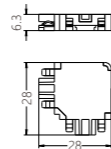

**CX20-C-L**  
尺寸 [Size]: 26x26x6.3mm  
(26x20mm)  
材质 [Material]: PC

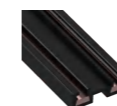
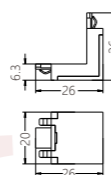

**CX20-M-G**  
尺寸 [Size]: 20x6.3mm  
材质 [Material]: PC

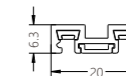

**CX20-G-C**  
尺寸 [Size]: 20x4mm  
材质 [Material]: PC

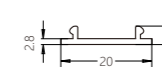

**CX20-C-XS**  
尺寸 [Size]: 75.9x30.4x20mm  
材质 [Material]: PC

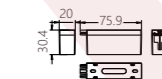

**CX20-100W电源**  
尺寸 [Size]: 256.3x24.2x20mm  
材质 [Material]: PC

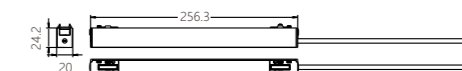

**CX20-150W电源**  
尺寸 [Size]: 323.8x24.2x20mm  
材质 [Material]: PC

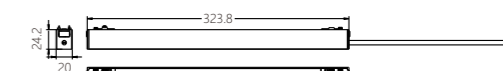

+866-18680577977



Trimless



1 LED | 5W

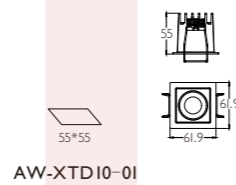

AW-XTD10-01



3 LED | 15W

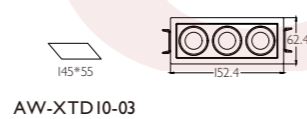

AW-XTD10-03



6 LED | 30W

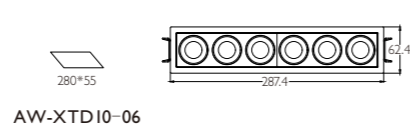

AW-XTD10-06



1 LED | 5W

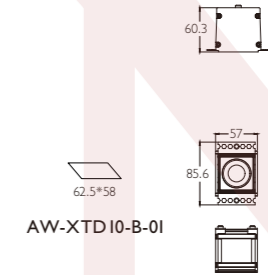

AW-XTD10-B-01



3 LED | 15W

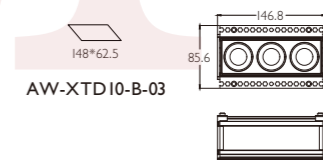

AW-XTD10-B-03



6 LED | 30W

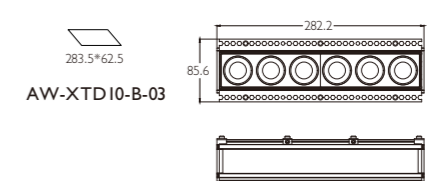

AW-XTD10-B-06

光学角度/Beam

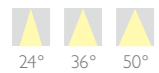

可选配件/Accessories



芯片/Chip

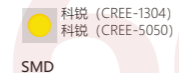

SMD

光学角度/Beam



可选配件/Accessories



芯片/Chip



SMD

+866-18680577977



**XTD13-YX-A**

尺寸 [Size]: 44.3x44.3x55mm  
 功率 [Power]: 5W  
 材质 [Material]: Die casting aluminium+PC

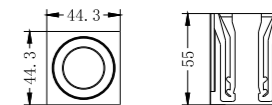

**XTD13-FX-A**

尺寸 [Size]: 44.3x44.3x55mm  
 功率 [Power]: 5W  
 材质 [Material]: Die casting aluminium+PC

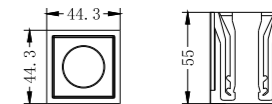

**XTD13-PG**

尺寸 [Size]: 44.3x44.3x80.3mm  
 功率 [Power]: 5W  
 材质 [Material]: Die casting aluminium+PC

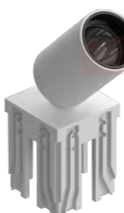
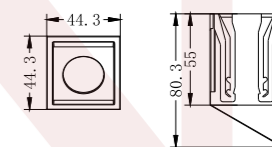

**XTD13-GD**

尺寸 [Size]: 44.3x44.3x119mm  
 功率 [Power]: 5W  
 材质 [Material]: Die casting aluminium+PC

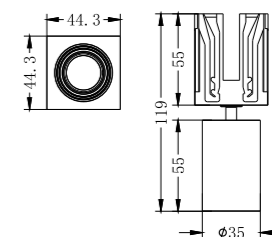

**XTD13-PC**

尺寸 [Size]: 44.3x44.3x55mm  
 材质 [Material]: PC

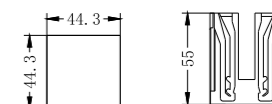

**XTD13系列**  
 XTD13 Series

Free DIY combination

可选灯体颜色/Fixture Colors



可选配件/Accessories



可选光学角度/Beam

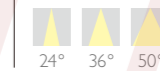

芯片/Chip





**XTD13-YX-Z**

尺寸 [Size]: 44.3x44.3x62.5mm  
 功率 [Power]: 5W  
 材质 [Material]: Die casting aluminium+PC

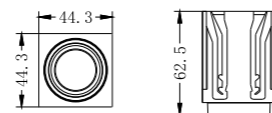

**XTD13-FX-Z**

尺寸 [Size]: 44.3x44.3x62.5mm  
 功率 [Power]: 5W  
 材质 [Material]: Die casting aluminium+PC

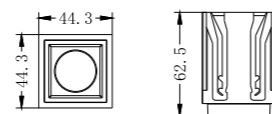

**XTD13-YX-X**

尺寸 [Size]: 44.3x44.3x62.5mm  
 功率 [Power]: 5W  
 材质 [Material]: Die casting aluminium+PC

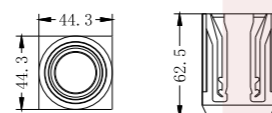

**XTD13-FX-X**

尺寸 [Size]: 44.3x44.3x62.5mm  
 功率 [Power]: 5W  
 材质 [Material]: Die casting aluminium+PC

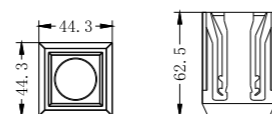

**XTD13-KT**

尺寸 [Size]: 44.3x44.3x63mm  
 功率 [Power]: 5W  
 材质 [Material]: Die casting aluminium+PC

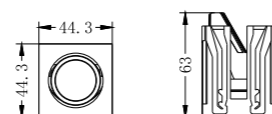

**XTD13-XZ-02**

尺寸 [Size]: 88.7x44.3x55mm  
 功率 [Power]: 2x4W  
 材质 [Material]: Die casting aluminium+PC

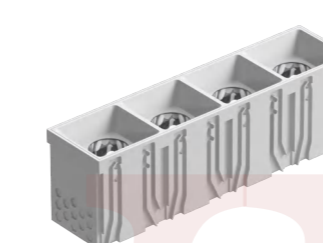
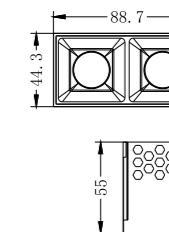

**XTD13-XZ-04**

尺寸 [Size]: 177.8x44.3x55mm  
 功率 [Power]: 4x4W  
 材质 [Material]: Die casting aluminium+PC

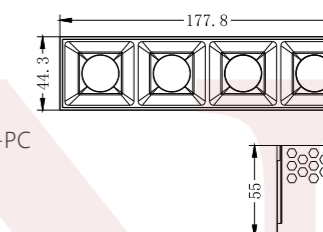

可选灯体颜色/Fixture Colors



可选配件/Accessories



可选光学角度/Beam



芯片/Chip



可选灯体颜色/Fixture Colors



防眩罩可选颜色/Reflector Colors



可选配件/Accessories



可选光学角度/Beam

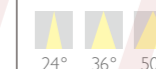

芯片/Chip



+866-18680577977



**XTD13-A-01**

尺寸 [Size]: 64x64x55.5mm  
 开孔尺寸 [Cut Hole]: 59.5\*55mm  
 材质 [Material]: Die casting aluminium+POM

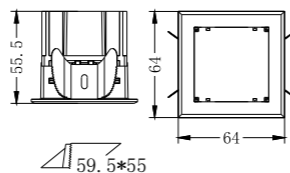

**XTD13-B-01**

尺寸 [Size]: 88x88x55.5mm  
 开孔尺寸 [Cut Hole]: 63\*63mm  
 材质 [Material]: PC+POM

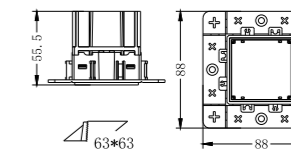

**XTD13-B-02**

尺寸 [Size]: 132.5x88x55.5mm  
 开孔尺寸 [Cut Hole]: 110\*63mm  
 材质 [Material]: PC+POM

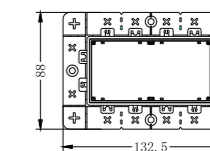

**XTD13-A-02**

尺寸 [Size]: 108.5x64x55.5mm  
 开孔尺寸 [Cut Hole]: 104\*55mm  
 材质 [Material]: Die casting aluminium+POM

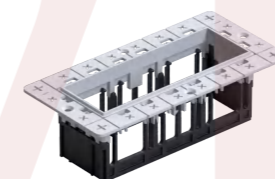
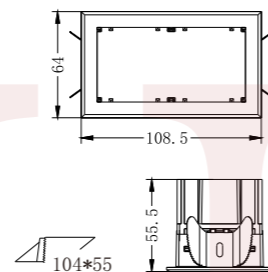

**XTD13-B-03**

尺寸 [Size]: 177x88x55.5mm  
 开孔尺寸 [Cut Hole]: 153\*63mm  
 材质 [Material]: PC+POM

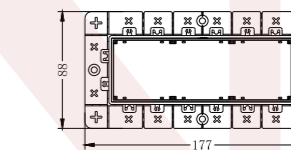

**XTD13-A-03**

尺寸 [Size]: 153x64x55.5mm  
 开孔尺寸 [Cut Hole]: 148.5\*55mm  
 材质 [Material]: Die casting aluminium+POM

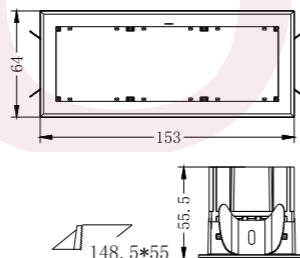

**XTD13-B-04**

尺寸 [Size]: 221.5x88x55.5mm  
 开孔尺寸 [Cut Hole]: 198\*63mm  
 材质 [Material]: PC+POM

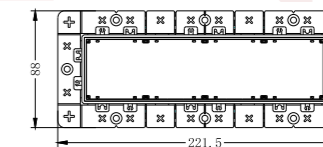

**XTD13-A-04**

尺寸 [Size]: 197.5x64x55.5mm  
 开孔尺寸 [Cut Hole]: 193\*55mm  
 材质 [Material]: Die casting aluminium+POM

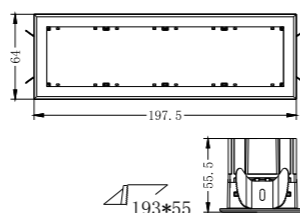

**无边组合 (DIY)**

可选面环颜色/Frame Colors



面环颜色/Frame Colors



+866-18680577977



One piece die-casting super slim design

Dimmable and CCT tunable



TD069-55

尺寸 [Size]:  $\Phi 62 \times 25 \text{mm}$   
 开孔尺寸 [Cut Hole]:  $\Phi 55 \text{mm}$   
 功率 [Power]: 5W  
 材质 [Material]: Die casting aluminium

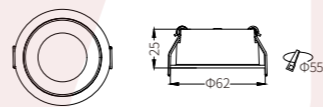

TD069-65

尺寸 [Size]:  $\Phi 72 \times 28.3 \text{mm}$   
 开孔尺寸 [Cut Hole]:  $\Phi 65 \text{mm}$   
 功率 [Power]: 9W  
 材质 [Material]: Die casting aluminium

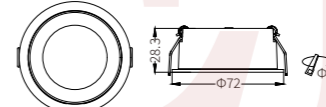

TD069-75

尺寸 [Size]:  $\Phi 83 \times 31.1 \text{mm}$   
 开孔尺寸 [Cut Hole]:  $\Phi 75 \text{mm}$   
 功率 [Power]: 12W  
 材质 [Material]: Die casting aluminium



TD069-95

尺寸 [Size]:  $\Phi 105 \times 34.4 \text{mm}$   
 开孔尺寸 [Cut Hole]:  $\Phi 95 \text{mm}$   
 功率 [Power]: 15W  
 材质 [Material]: Die casting aluminium

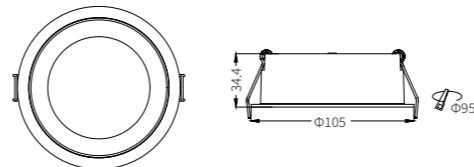

可选光学角度/Beam

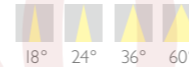

防眩罩可选颜色/Reflector Colors



芯片/Chip



COB

+8666-18680577977



NMW-GD-54

功率 [Power]: 10W

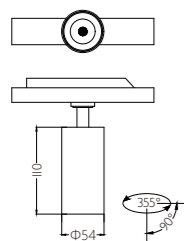

NMW-GD-68

功率 [Power]: 20W

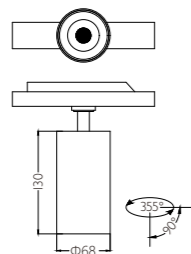

NMW-GD-85

功率 [Power]: 30W

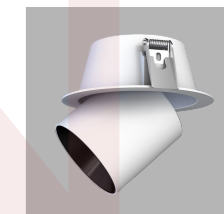
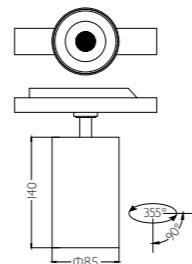

NMW-WX-100

功率 [Power]: 10W

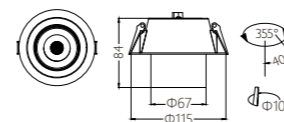

NMW-WX-170

功率 [Power]: 30W

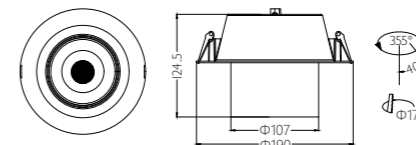

可选反射器颜色/Reflector Colors



光学角度/Beam



芯片/Chip



可选反射器颜色/Reflector Colors



光学角度/Beam

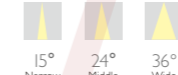

芯片/Chip



+866-18680577977

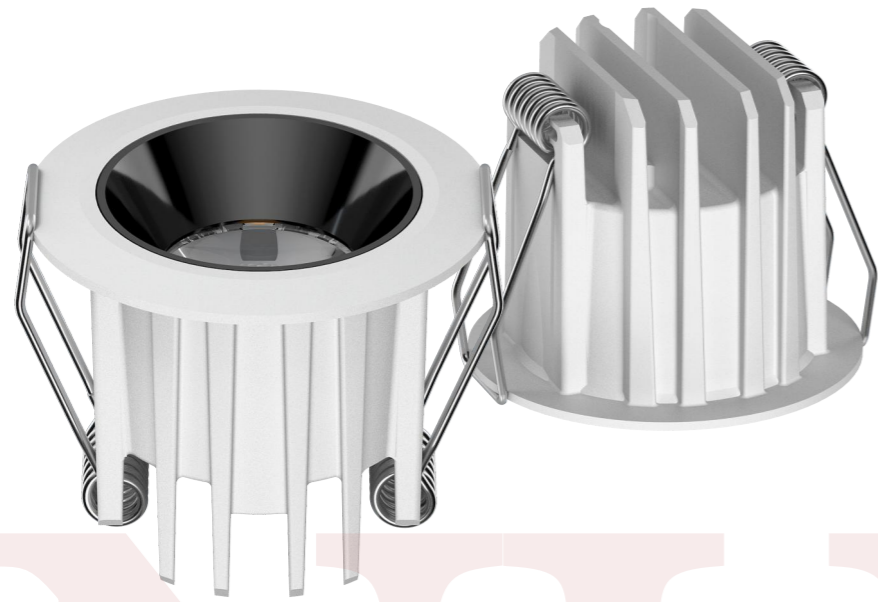

NMW-TD-50

功率 [Power]: 5W

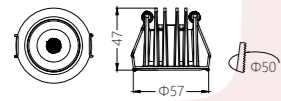

NMW-TD-60

功率 [Power]: 9W

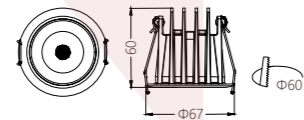

NMW-TD-75

功率 [Power]: 12W

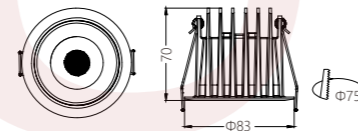

NMW-TD-90

功率 [Power]: 20W

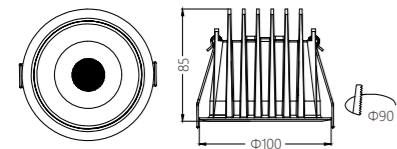

NMW-TD-120

功率 [Power]: 30W

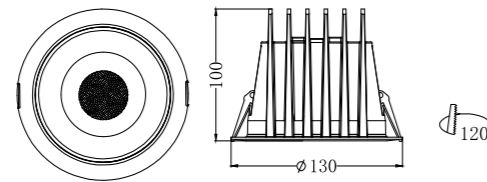

NMW-TSD-60

功率 [Power]: 7W

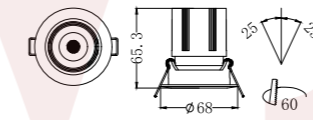

NMW-TSD-75

功率 [Power]: 12W

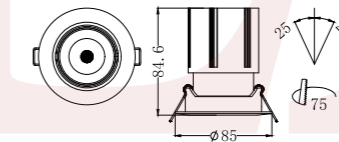

NMW-TSD-90

功率 [Power]: 20W

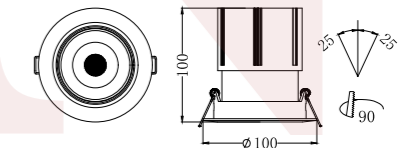

NMW-TSD-110

功率 [Power]: 30W  
流明 [Lumen]: 2700lm

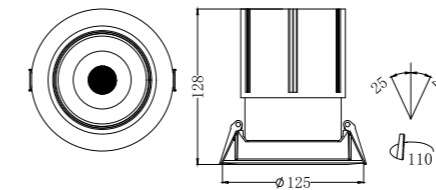

可选反射器颜色/Reflector Colors



光学角度/Beam

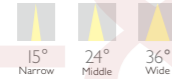

芯片/Chip

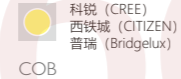

可选反射器颜色/Reflector Colors



光学角度/Beam



芯片/Chip

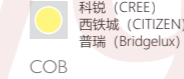

+86-18680577977

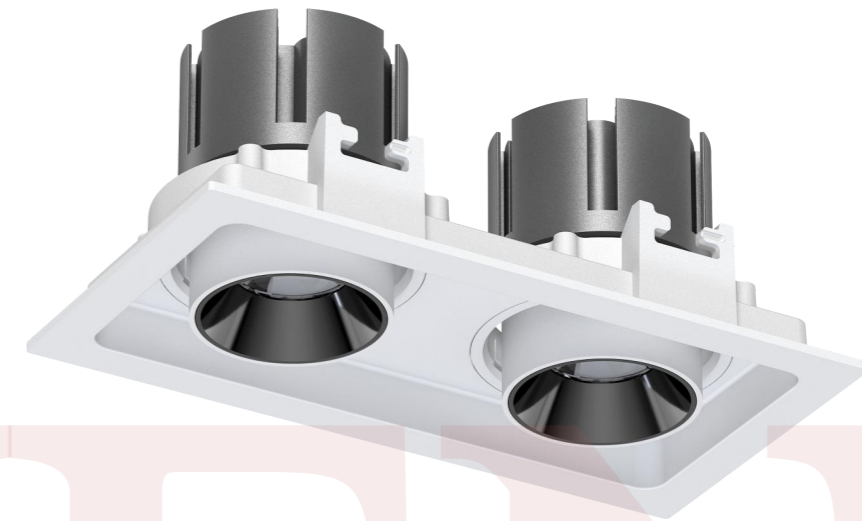

**NMW-GSD-R75**

功率 [Power]: 7W

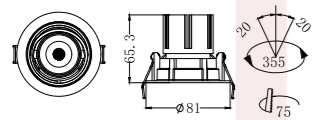

**NMW-GSD-R90**

功率 [Power]: 12W

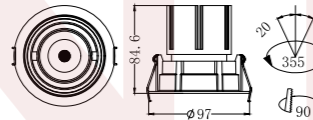

**NMW-GSD-R105**

功率 [Power]: 20W

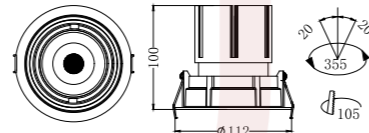

**NMW-GSD-R120**

功率 [Power]: 30W

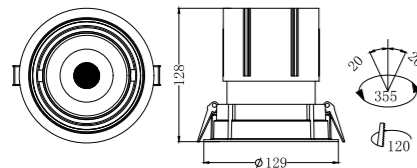

**NMW-GSD-S75**

功率 [Power]: 7W

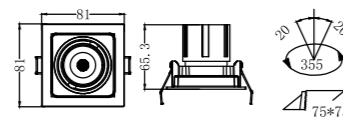

**NMW-GSD-S90**

功率 [Power]: 12W

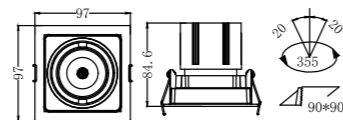

**NMW-GSD-S105**

功率 [Power]: 20W

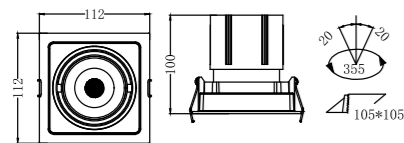

**NMW-GSD-S120**

功率 [Power]: 30W

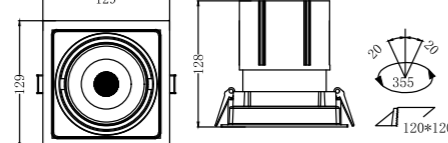

**NMW-GSD-S75-2**

功率 [Power]: 2\*7W

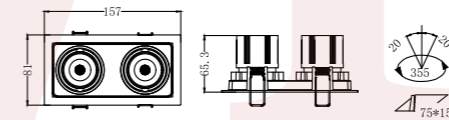

**NMW-GSD-S90-2**

功率 [Power]: 2\*12W

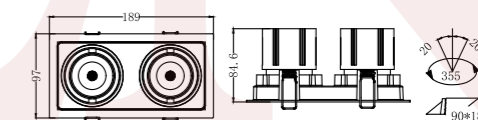

**NMW-GSD-S105-2**

功率 [Power]: 2\*20W

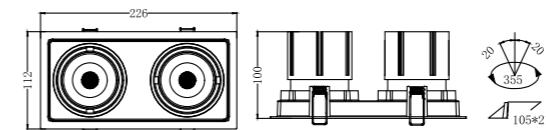

**NMW-GSD-S120-2**

功率 [Power]: 2\*30W

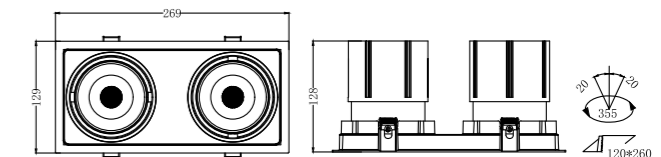

可选反射器颜色/Reflector Colors



光学角度/Beam



芯片/Chip

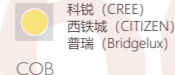

可选反射器颜色/Reflector Colors



光学角度/Beam

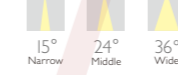

芯片/Chip



+86-18680577977



NMW-O75

NMW-R75

NMW-S75

功率 [Power]: 12W

功率 [Power]: 10W

功率 [Power]: 12W

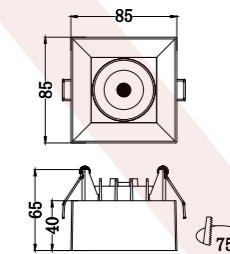
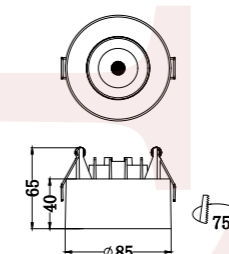
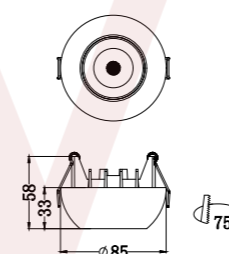

NMW-O55

NMW-R55

NMW-S55

功率 [Power]: 7W

功率 [Power]: 7W

功率 [Power]: 7W

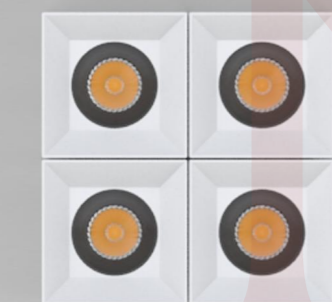
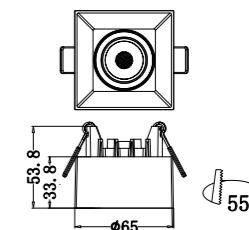
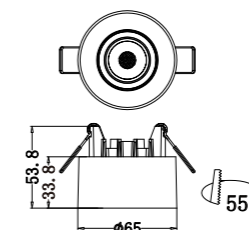
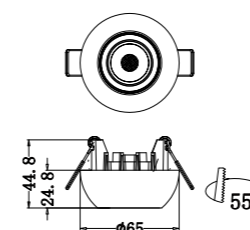

Free combination  
Various shaping  
DIY your lighting

自由组合  
多种造型  
DIY你的空间

可选反射器颜色/Reflector Colors

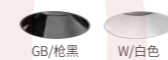

光学角度/Beam

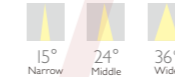

芯片/Chip

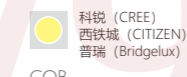

1-8666-18680577977



XTDR1-A-6



XTDR1-A-12



XTDR1-A-18



XTDR1-A-24



C-12



C-18

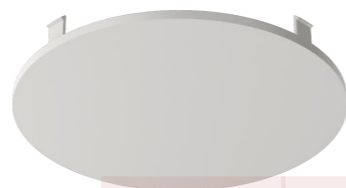

C-24



XTDR1-B-06

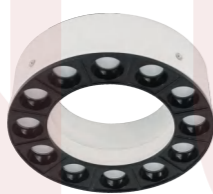

XTDR1-B-12

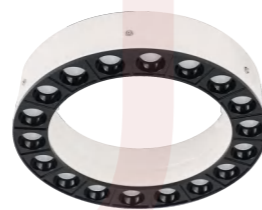

XTDR1-B-18



### XTDR1-A-06

功率 [Power]: 8W  
色温 [CCT]: 3000K | 4000K | 5000K  
眩光值 [UGR]: < 17  
显指 [CRI]: 90+  
材质 [Material]: Die casting aluminium  
颜色 [Color]: WH/BK

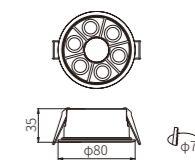

### XTDR1-A-12

功率 [Power]: 15W  
色温 [CCT]: 3000K | 4000K | 5000K  
眩光值 [UGR]: < 17  
显指 [CRI]: 90+  
材质 [Material]: Die casting aluminium  
颜色 [Color]: WH/BK

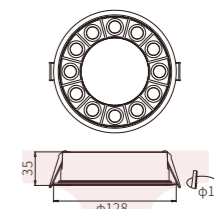

### XTDR1-A-18

功率 [Power]: 20W  
色温 [CCT]: 3000K | 4000K | 5000K  
眩光值 [UGR]: < 17  
显指 [CRI]: 90+  
材质 [Material]: Die casting aluminium  
颜色 [Color]: WH/BK

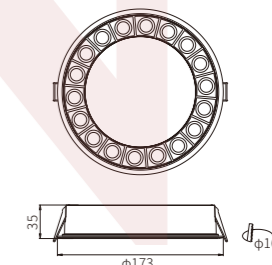
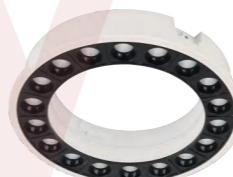

### XTDR1-A-24

功率 [Power]: 30W  
色温 [CCT]: 3000K | 4000K | 5000K  
眩光值 [UGR]: < 17  
显指 [CRI]: 90+  
材质 [Material]: Die casting aluminium  
颜色 [Color]: WH/BK

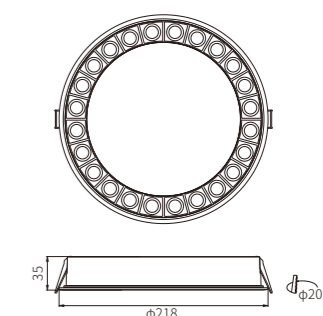

+866-18680577977

光学角度/Beam



芯片/Chip



可选反光器颜色/Reflector Colors





**XTDRI-B-06**

功率 [Power]: 8W  
 色温 [CCT]: 3000K | 4000K | 5000K  
 眩光值 [UGR]: < 17  
 显指 [CRI]: 90+  
 材质 [Material]: Die casting aluminium  
 颜色 [Color]: WH/BK

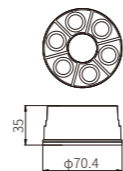

**MD009-12**

功率 [Power]: 15W  
 色温 [CCT]: 3000K | 4000K | 5000K  
 眩光值 [UGR]: < 17  
 显指 [CRI]: 90+  
 材质 [Material]: Die casting aluminium  
 颜色 [Color]: WH/BK

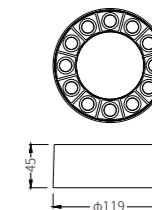

**XTDRI-B-12**

功率 [Power]: 15W  
 色温 [CCT]: 3000K | 4000K | 5000K  
 眩光值 [UGR]: < 17  
 显指 [CRI]: 90+  
 材质 [Material]: Die casting aluminium  
 颜色 [Color]: WH/BK

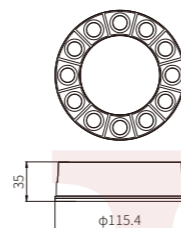

**MD009-18**

功率 [Power]: 20W  
 色温 [CCT]: 3000K | 4000K | 5000K  
 眩光值 [UGR]: < 17  
 显指 [CRI]: 90+  
 材质 [Material]: Die casting aluminium  
 颜色 [Color]: WH/BK

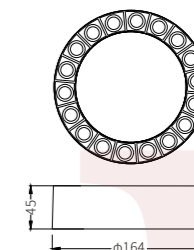

**XTDRI-B-18**

功率 [Power]: 20W  
 色温 [CCT]: 3000K | 4000K | 5000K  
 眩光值 [UGR]: < 17  
 显指 [CRI]: 90+  
 材质 [Material]: Die casting aluminium  
 颜色 [Color]: WH/BK

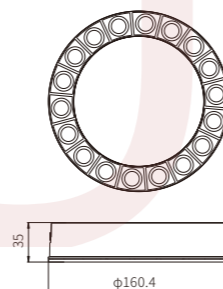

**MD009-24**

功率 [Power]: 30W  
 色温 [CCT]: 3000K | 4000K | 5000K  
 眩光值 [UGR]: < 17  
 显指 [CRI]: 90+  
 材质 [Material]: Die casting aluminium  
 颜色 [Color]: WH/BK

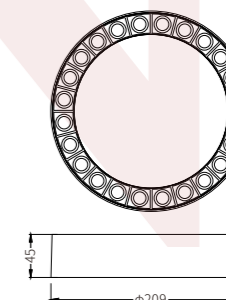

芯片/Chip  
 3030(OSRAM)  
 SMD

可选反光器颜色/Reflector Colors

光学角度/Beam  
  
 20° 34° 48°

芯片/Chip  
 3030(OSRAM)  
 SMD

可选反光器颜色/Reflector Colors

+866-18680577977



# LINEAR

Light  
线条灯系列



### XTD9-03

尺寸 [Size]: 95x45x49.5mm  
开孔尺寸 [Cut Hole]: 87x37mm  
功率 [Power]: 8W  
材质 [Material]: Die casting aluminium

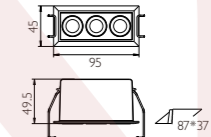

### XTD9-06

尺寸 [Size]: 174x45x49.5mm  
开孔尺寸 [Cut Hole]: 165x37mm  
功率 [Power]: 15W  
材质 [Material]: Die casting aluminium

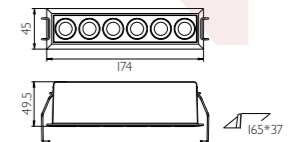

### XTD9-12

尺寸 [Size]: 333x45x49.5mm  
开孔尺寸 [Cut Hole]: 325x37mm  
功率 [Power]: 24W  
材质 [Material]: Die casting aluminium

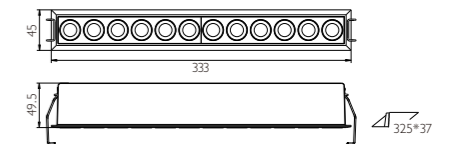

可选光学角度/Beam



芯片/Chip

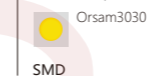

+8666-18680577977

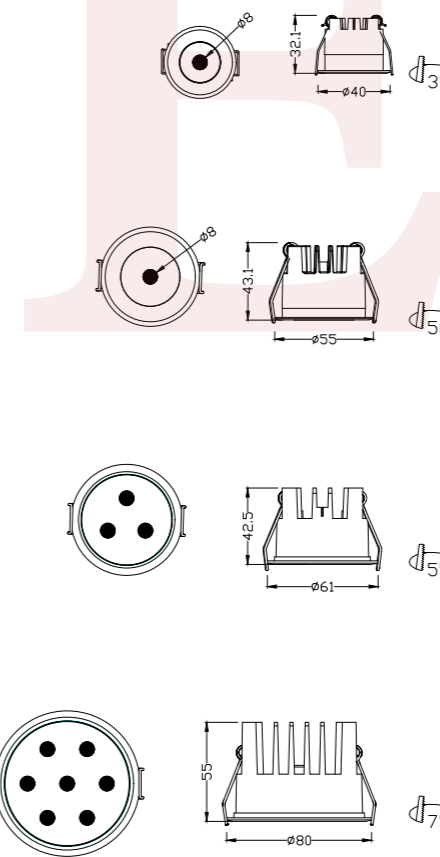
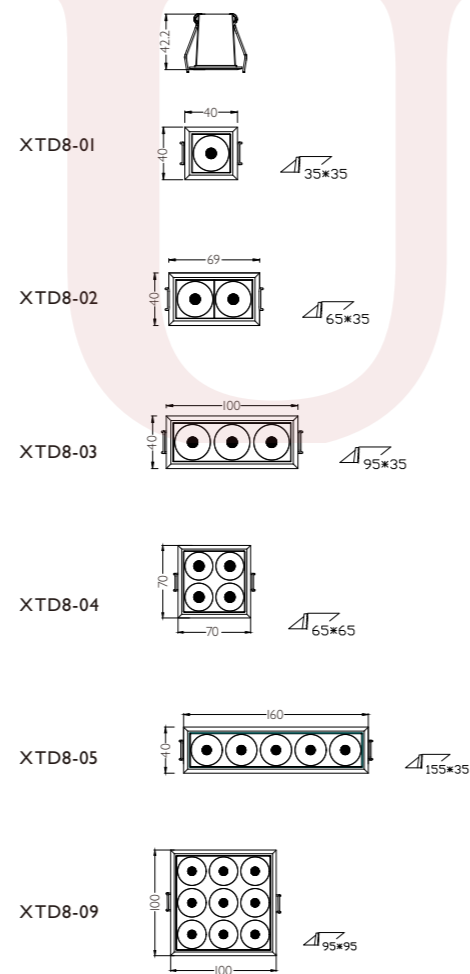
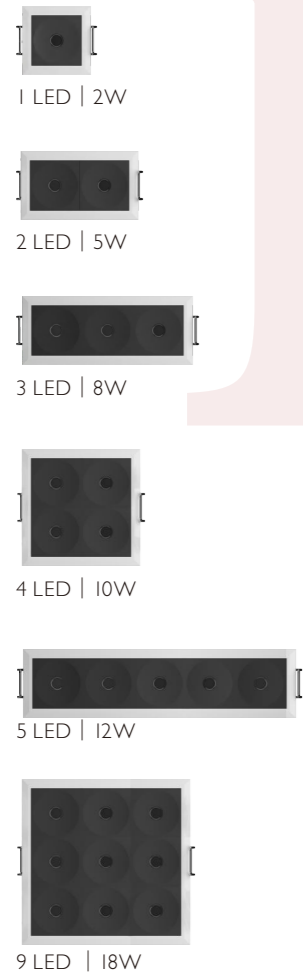

**TSD010-35**  
 功率 [Power]: 2.5W  
 材质 [Material]: Die-cast aluminum  
 开孔 [Cut Hole]:  $\Phi$ 35mm

**TSD010-50**  
 功率 [Power]: 4W  
 材质 [Material]: Die-cast aluminum  
 开孔 [Cut Hole]:  $\Phi$ 50mm

**TSD010-55**  
 功率 [Power]: 8W  
 材质 [Material]: Die-cast aluminum  
 开孔 [Cut Hole]:  $\Phi$ 55mm

**TSD010-75**  
 功率 [Power]: 15W  
 材质 [Material]: Die-cast aluminum  
 开孔 [Cut Hole]:  $\Phi$ 75mm

光学角度/Beam 24°

芯片/Chip 3030 3535 SMD

光学角度/Beam 24°



NEW

AW-XTD6



NEW

AW-XTD6

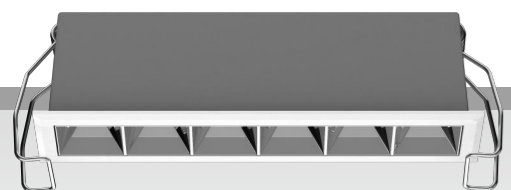

1 LED | 2W | 120lm  
3000K | 4000K | 5000K | 6000K  
UGR<17 | CRI 90+  
Die casting aluminium

4 LED | 5W | 350lm  
3000K | 4000K | 5000K | 6000K  
UGR<17 | CRI 90+  
Die casting aluminium



3 LED | 4W | 280lm  
3000K | 4000K | 5000K | 6000K  
UGR<17 | CRI 90+  
Die casting aluminium

9 LED | 10W | 700lm  
3000K | 4000K | 5000K | 6000K  
UGR<17 | CRI 90+  
Die casting aluminium



6 LED | 8W | 560lm  
3000K | 4000K | 5000K | 6000K  
UGR<17 | CRI 90+  
Die casting aluminium

16 LED | 15W | 1050lm  
3000K | 4000K | 5000K | 6000K  
UGR<17 | CRI 90+  
Die casting aluminium



12 LED | 15W | 1050lm  
3000K | 4000K | 5000K | 6000K  
UGR<17 | CRI 90+  
Die casting aluminium

25 LED | 20W | 1400lm  
3000K | 4000K | 5000K | 6000K  
UGR<17 | CRI 90+  
Die casting aluminium

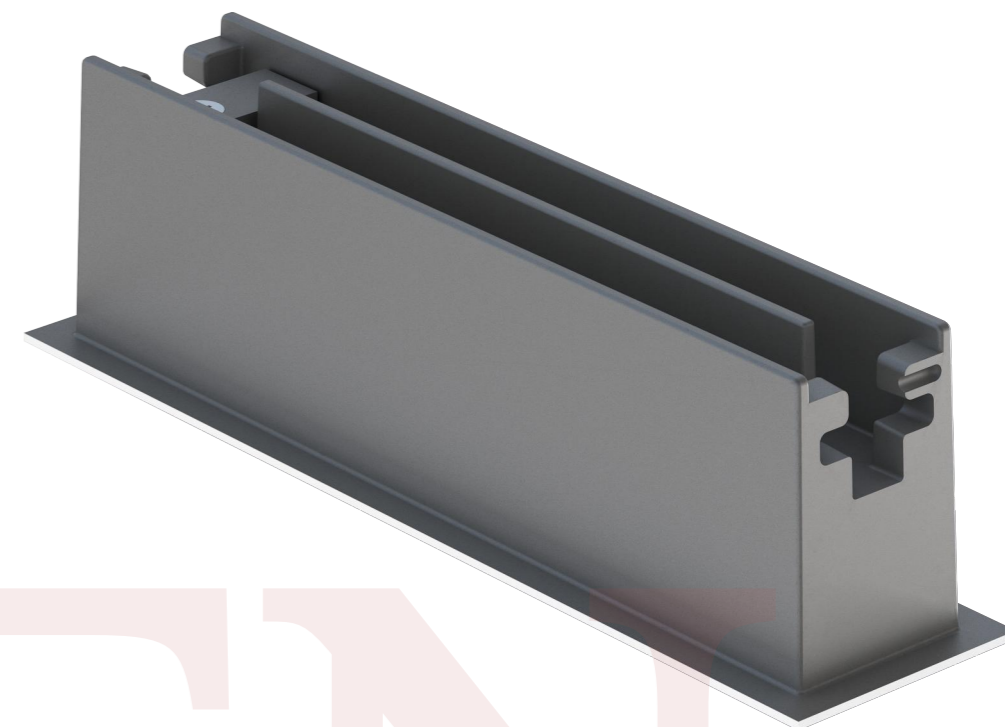

NUWEN

26\*26  
XTD6-1

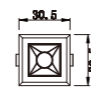

64\*26  
XTD6-3

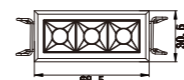

121\*26  
XTD6-6



235\*26  
XTD6-12

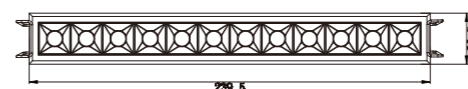

45\*45  
XTD6-04

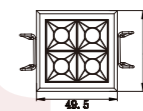

64\*64  
XTD6-09

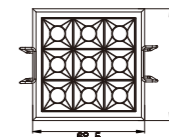

83\*83  
XTD6-16

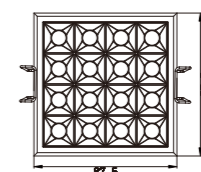

101.5\*101.5  
XTD6-25

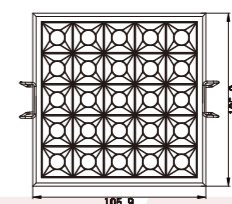

Beam Angle

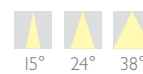

Chip



Optional Baffle Color

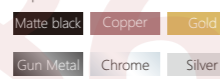

+866-18680577977



**MD007-4**  
 Power: 5W  
 CCT: 3000K | 4000K | 5000K | 6000K  
 Lumen: 300lm  
 Beam angle: 15° | 24° | 38°  
 UGR: < 17  
 CRI: 90+  
 Material: Die casting aluminium  
 Color: WH/BK

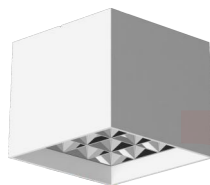
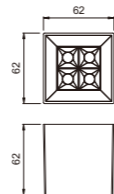

**MD007-9**  
 Power: 10W  
 CCT: 3000K | 4000K | 5000K | 6000K  
 Lumen: 600lm  
 Beam angle: 15° | 24° | 38°  
 UGR: < 17  
 CRI: 90+  
 Material: Die casting aluminium  
 Color: WH/BK

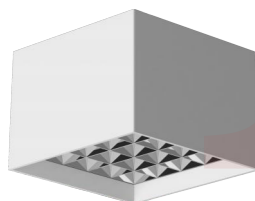
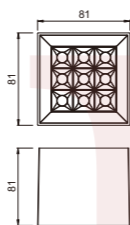

**MD007-16**  
 Power: 16W  
 CCT: 3000K | 4000K | 5000K | 6000K  
 Lumen: 1040lm  
 Beam angle: 15° | 24° | 38°  
 UGR: < 17  
 CRI: 90+  
 Material: Die casting aluminium  
 Color: WH/BK

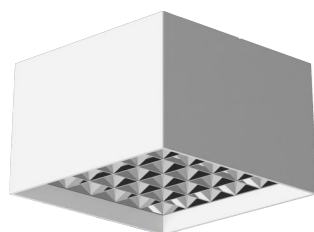
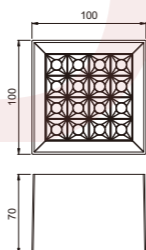

**MD007-25**  
 Power: 25W  
 CCT: 3000K | 4000K | 5000K | 6000K  
 Lumen: 1625lm  
 Beam angle: 15° | 24° | 38°  
 UGR: < 17  
 CRI: 90+  
 Material: Die casting aluminium  
 Color: WH/BK

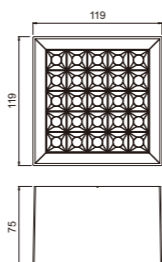

Beam Angle  

 15° 24° 38°

Chip  

 SMD

Optional Baffle Color  

 Matte black Copper Gold  
 Gun Metal Chrome Silver



+806-1868

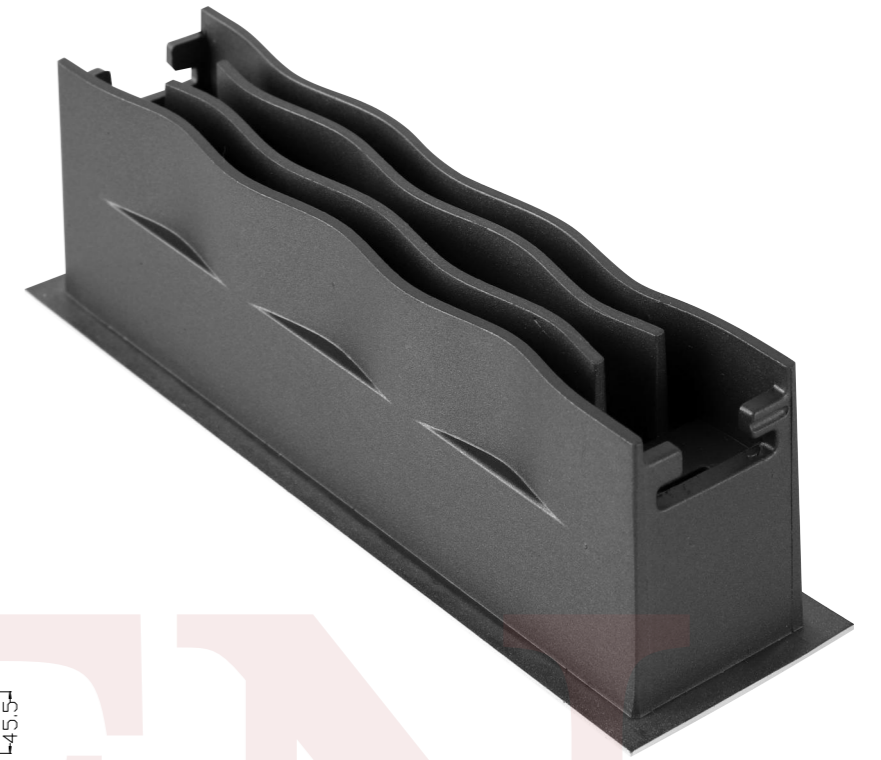

1 LED | 3W



3 LED | 6W



4 LED | 10W

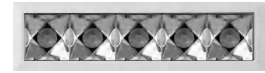

5 LED | 12W

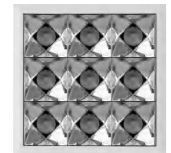

9 LED | 18W

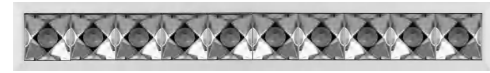

10 LED | 24W

光学角度/Beam

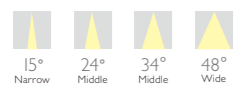

芯片/Chip

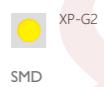

40\*40

AW-XTD5-1

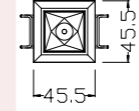
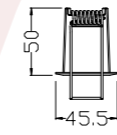

100\*40

AW-XTD5-3

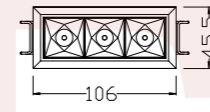
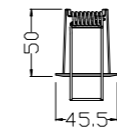

70\*70

AW-XTD5-4

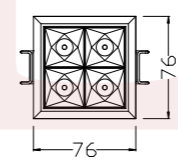
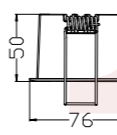

160\*40

AW-XTD5-5

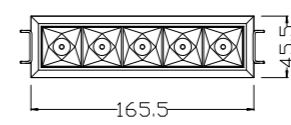
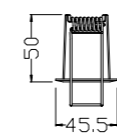

100\*100

AW-XTD5-9

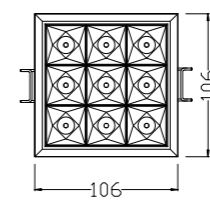
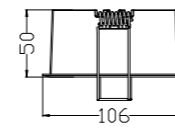

310\*40

AW-XTD5-10

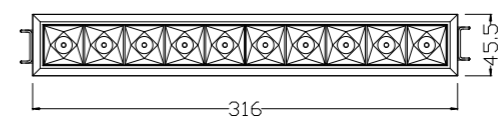
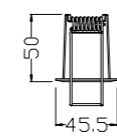

NUWEN

+866-18680577977



2 LED | 3W

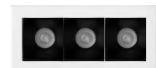

3 LED | 5W



4 LED | 7W



6 LED | 8W



9 LED | 12W



12 LED | 20W



2 LED | 3W

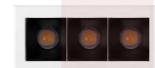

3 LED | 5W



4 LED | 7W

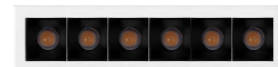

6 LED | 8W



9 LED | 12W

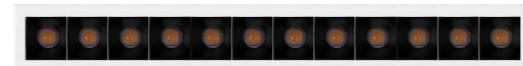

12 LED | 20W

光学角度/Beam

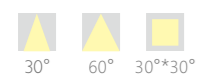

芯片/Chip

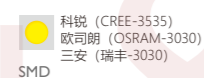

NUWEN



48\*27.5  
AW-XTD3-02



57\*27.5  
AW-XTD3-03



48\*48  
AW-XTD3-04



104\*27.5  
AW-XTD3-06



68\*68  
AW-XTD3-09



200\*27.5  
AW-XTD3-12

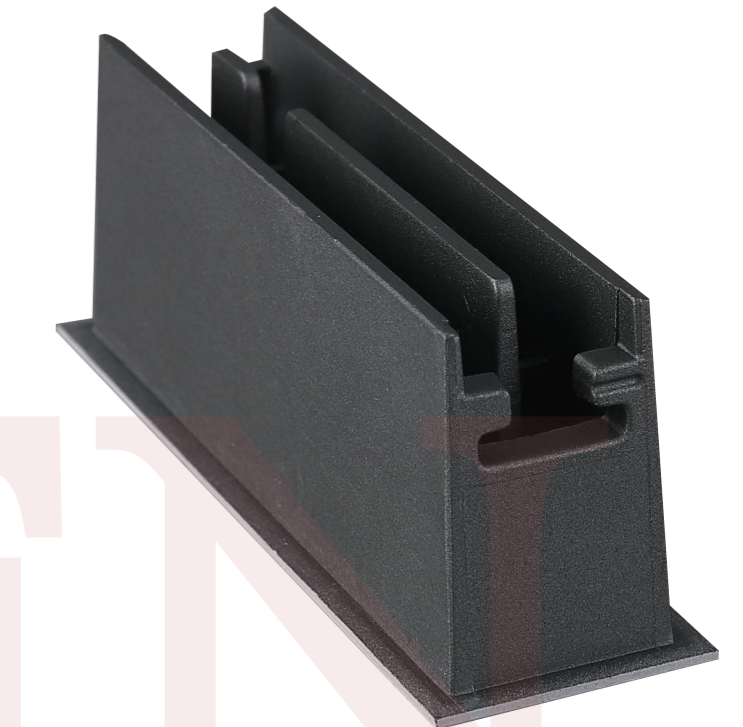
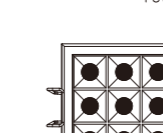
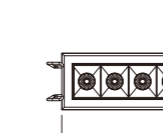
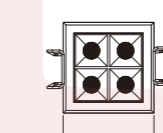
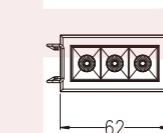
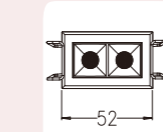
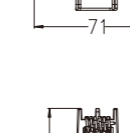
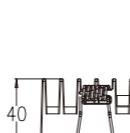
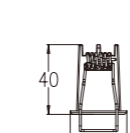
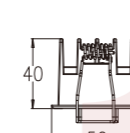
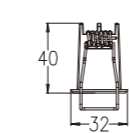
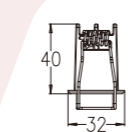

+866-18680577977

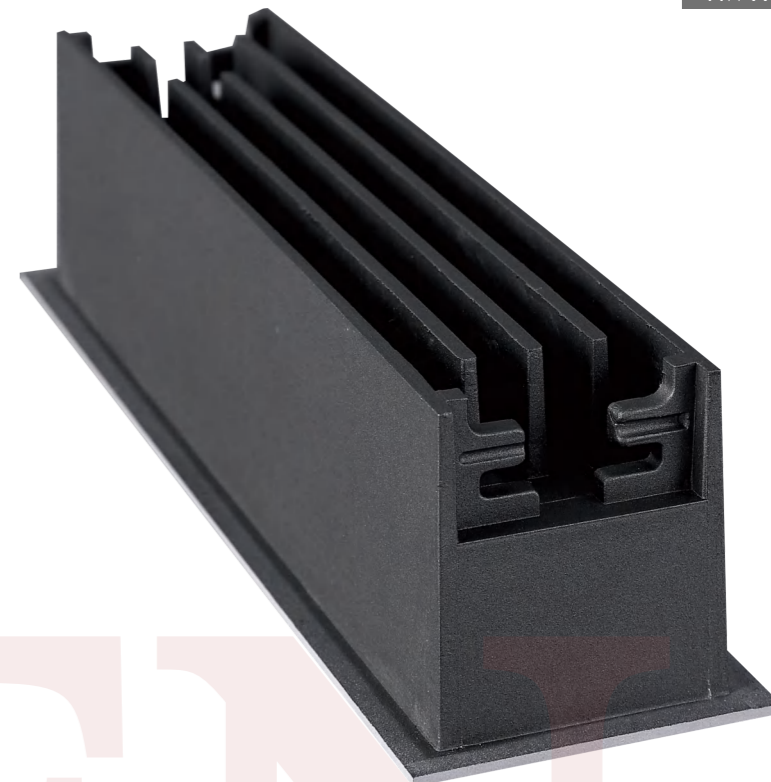
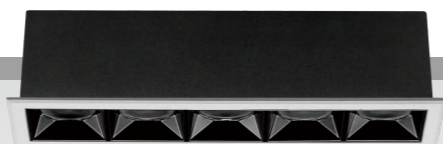

1 LED | 5W



3 LED | 12W



4 LED | 15W



5 LED | 20W



9 LED | 36W

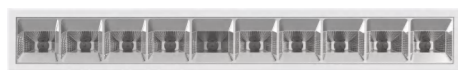

10 LED | 40W



1 LED | 5W



3 LED | 12W



4 LED | 15W



5 LED | 20W



9 LED | 36W



10 LED | 40W



AW-XTD2-01

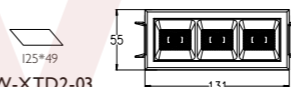
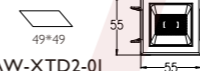

AW-XTD2-03

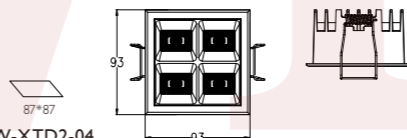
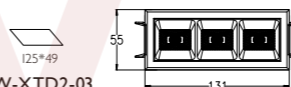

AW-XTD2-04

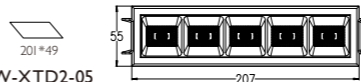
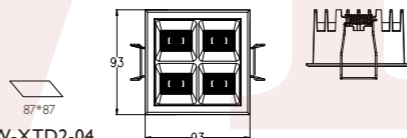

AW-XTD2-05

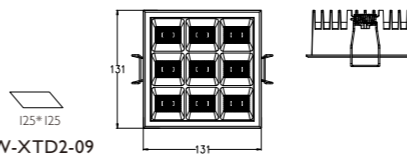
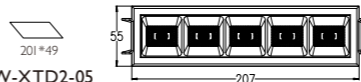

AW-XTD2-09

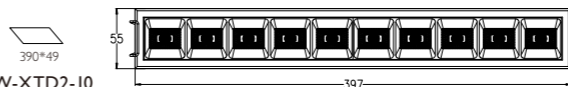
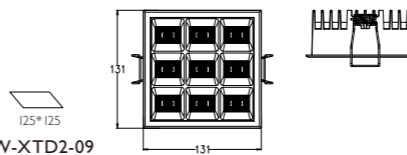

AW-XTD2-10

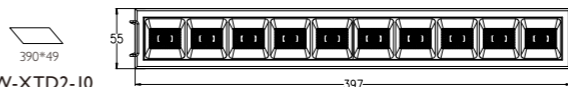

光学角度/Beam

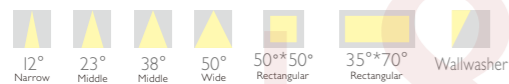

芯片/Chip

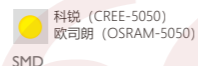

+866-18680577977

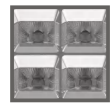

4 LED | 15W



4 LED | 15W

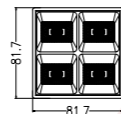

AW-MD006-4

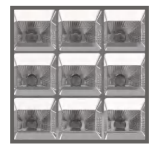
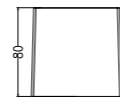

9 LED | 36W



9 LED | 36W

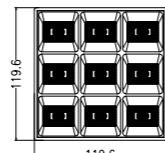

AW-MD006-9



光学角度/Beam

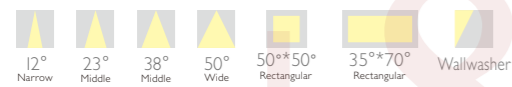

芯片/Chip

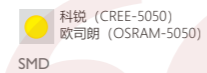

+866-1868



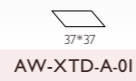

AW-XTD-A-01

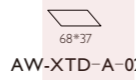
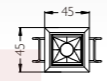

AW-XTD-A-02

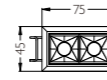

AW-XTD-A-03

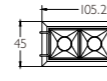

AW-XTD-A-05

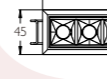

AW-XTD-A-10

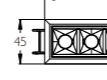

AW-XTD-A-15

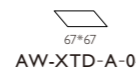
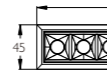

AW-XTD-A-04

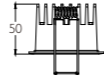
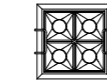

AW-XTD-A-09

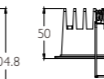
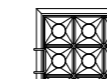

LIGHT EFFECT

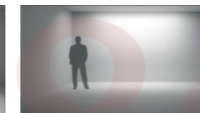
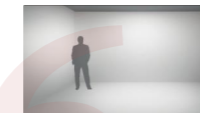

1 LED | 3W



2 LED | 5W



3 LED | 6W



5 LED | 10W



10 LED | 20W



15 LED | 30W



4 LED | 8W



9 LED | 18W

光学角度/Beam

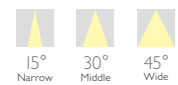

芯片/Chip



Trimless



1 LED | 3W



2 LED | 5W



5 LED | 10W



10 LED | 20W



15 LED | 30W

光学角度/Beam

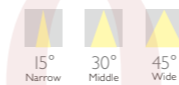

芯片/Chip

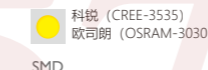

AW-XTD-B-01

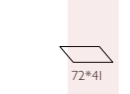

AW-XTD-B-02

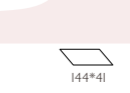

AW-XTD-B-05

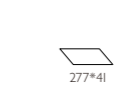

AW-XTD-B-10

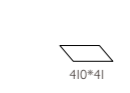

AW-XTD-B-15



+866-18680577977



5 LED | 10W

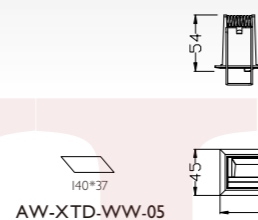

AW-XTD-WW-05



10 LED | 20W

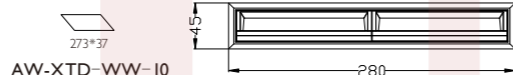

AW-XTD-WW-10



15 LED | 30W

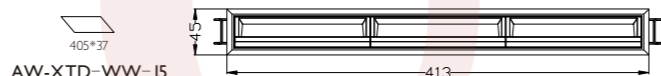

AW-XTD-WW-15



10 LED | 10W

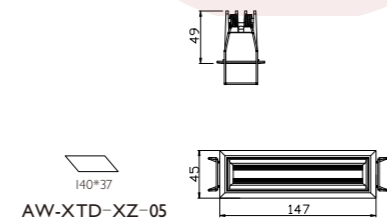

AW-XTD-XZ-05



20 LED | 20W



AW-XTD-XZ-10



30 LED | 30W



AW-XTD-XZ-15



10 LED | 5W

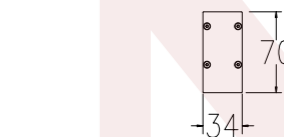

AW-XTD3470-05



20 LED | 10W

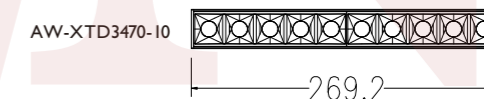

AW-XTD3470-10



30 LED | 15W

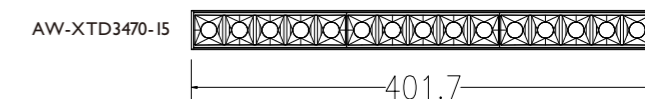

AW-XTD3470-15

光学角度/Beam

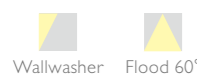

芯片/Chip

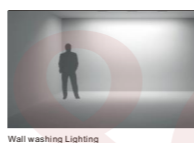
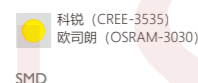

Wall washing Lighting

光学角度/Beam



芯片/Chip

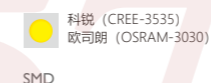

+866-18680577977



1 LED | 10W



2 LED | 20W



3 LED | 30W

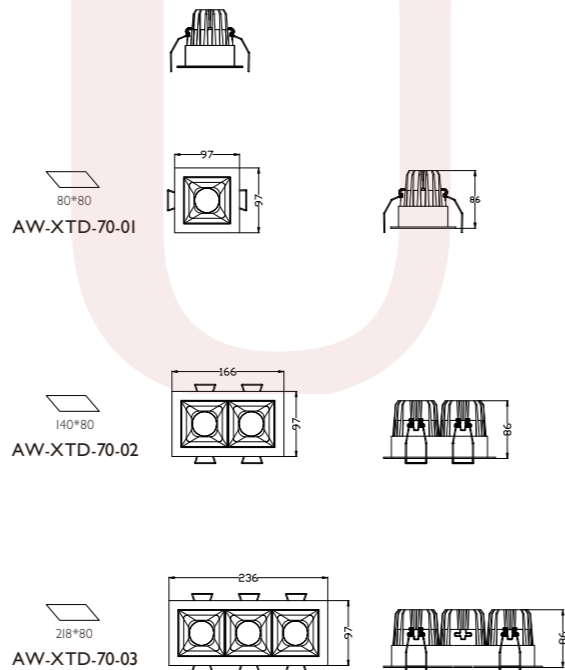

光学角度/Beam

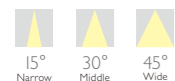

芯片/Chip



COB

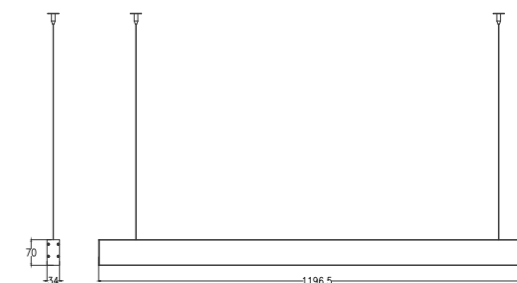

AW-XTD3470-1200A 30W

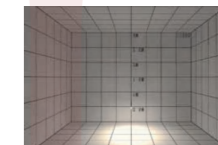

AW-XTD3470-1200B 40W

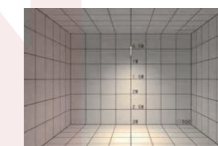

AW-XTD3470-1200C 40W

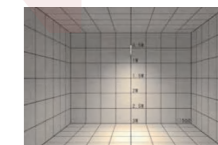

AW-XTD3470-1200D 40W

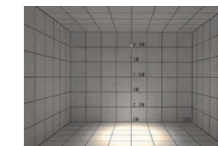

AW-XTD3470-1200E 40W

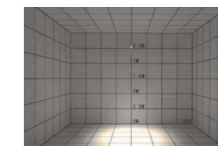

光学角度/Beam



芯片/Chip

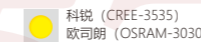

SMD

+866-18680577977

# MINI SPOT



Light

迷你天花射灯系列



TSD009



Make lights as you like

任意造形  
随心所欲



### TSD009-25

功率 [Power]: 1.5W  
角度 [Beam]: 15°, 27°, 60°  
芯片 [Chip]: OSRAM 3030  
材质 [Material]: Die-cast aluminum  
开孔 [Cut Hole]:  $\Phi$ 26mm

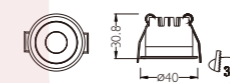

### TSD009-35

功率 [Power]: 2.5W  
角度 [Beam]: 15°, 25°, 50°  
芯片 [Chip]: OSRAM 3030  
材质 [Material]: Die-cast aluminum  
开孔 [Cut Hole]:  $\Phi$ 35mm

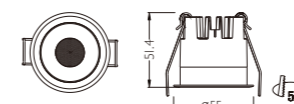

### TSD009-50

功率 [Power]: 4W  
角度 [Beam]: 15°, 25°, 45°  
芯片 [Chip]: OSRAM 3030  
材质 [Material]: Die-cast aluminum  
开孔 [Cut Hole]:  $\Phi$ 50mm

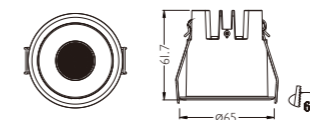

### TSD009-60

功率 [Power]: 8W  
角度 [Beam]: 20°, 40°  
芯片 [Chip]: COB CREE 1304  
材质 [Material]: Die-cast aluminum  
开孔 [Cut Hole]:  $\Phi$ 60mm

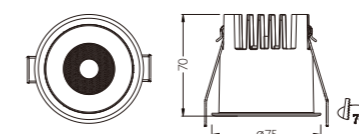

### TSD009-70

功率 [Power]: 12W  
角度 [Beam]: 15°, 24°, 36°  
芯片 [Chip]: COB CREE 1507  
材质 [Material]: Die-cast aluminum  
开孔 [Cut Hole]:  $\Phi$ 70mm



IP54

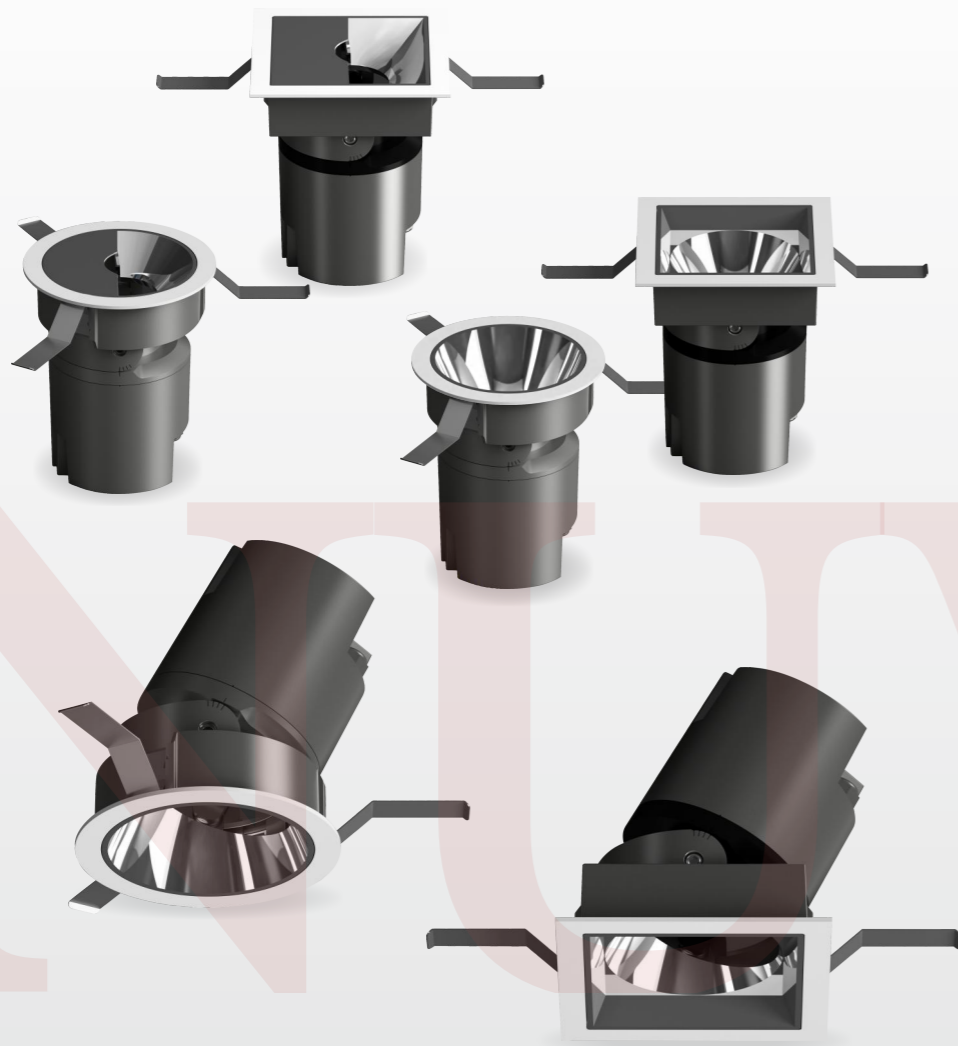

Rond

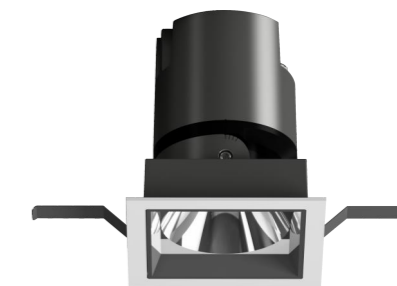

Square



Fixed/下照



Adjustable/可调



Wallwasher/洗墙



Fixed/下照

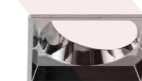

Adjustable/可调



Wallwasher/洗墙

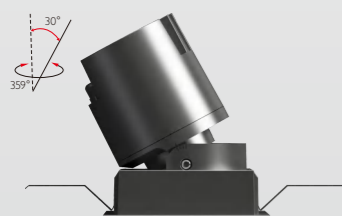

SQUARE  
ADJUSTABLE

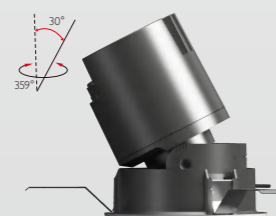

ROUND  
ADJUSTABLE

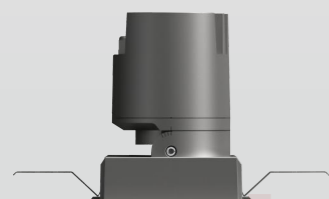

SQUARE  
FIXED

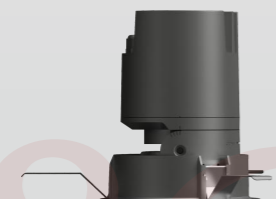

ROUND  
FIXED

Available Colors/可选反射器颜色



CH/铬色



GD/金色



SL/银色



BK/黑色



WH/白色

+8066-18680577977



可调(Adjustable) 					
					
HTSD-A-R60	HTSD-A-R80	HTSD-A-R100	HTSD-A-S60	HTSD-A-S80	HTSD-A-S100
					
					
					
7W	12W	20W	7W	12W	20W
 18° Narrow  24° Middle  36° Wide			 科锐 (CREE)  西铁城 (CITIZEN) COB		
 CH/铬色  GD/金色  SL/银色  BK/黑色  WH/白色					
 Accessories/配件					

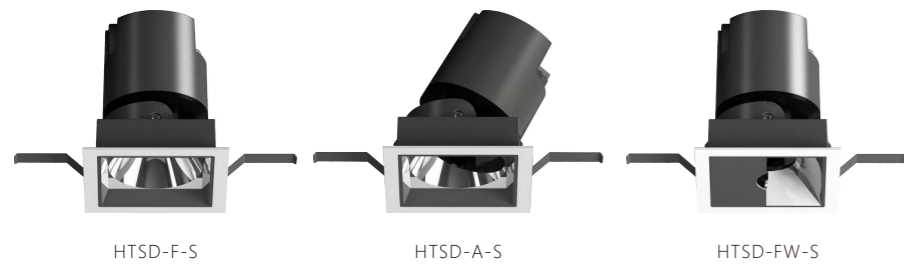

HTSD-F-S      HTSD-A-S      HTSD-FW-S



HTSD-F-R      HTSD-A-R      HTSD-FW-R

+866-18680577977

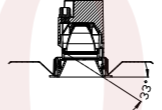





Ø50

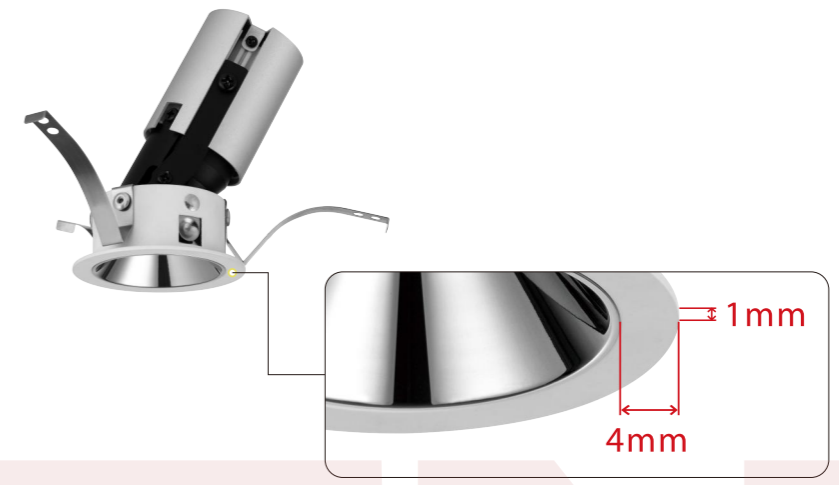

FOUNDATION  
Fixed downlight

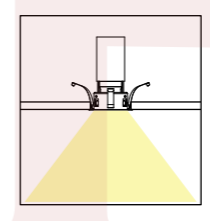

SD50A 5W



SD50A 8W



SD50A 12W

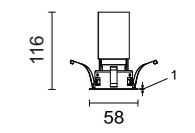
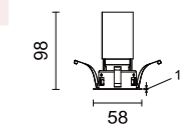
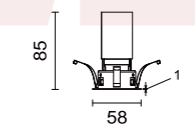

PICK UP  
Adjustable downlight

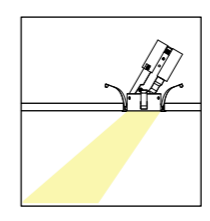

SD50B 5W



SD50B 8W

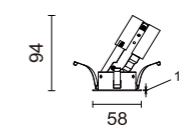

光学角度/Beam  
24° Middle  
36° Wide

芯片/Chip  
科锐 (CREE)  
西铁城 (CITIZEN)  
COB 明明纳斯 (Luminus)

Accessories/配件

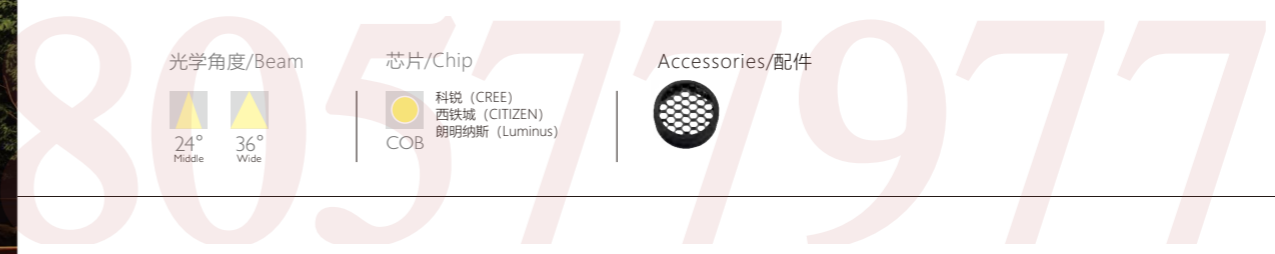

# SPOT

Light

天花射灯系列



+866-18680577977

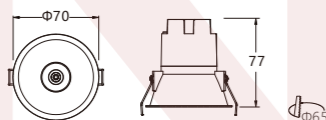

**TSD002-2F**  
 功率 [Power]: 5W  
 材质 [Material]: Die-cast aluminum+PC  
 开孔 [Cut Hole]:  $\Phi$ 65mm

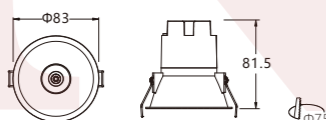

**TSD002-2.5F**  
 功率 [Power]: 5W  
 材质 [Material]: Die-cast aluminum+PC  
 开孔 [Cut Hole]:  $\Phi$ 75mm

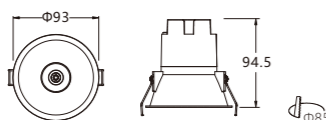

**TSD002-3F**  
 功率 [Power]: 10W  
 材质 [Material]: Die-cast aluminum+PC  
 开孔 [Cut Hole]:  $\Phi$ 85mm

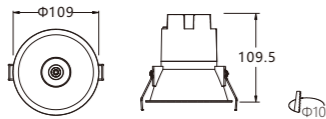

**TSD002-3.5F**  
 功率 [Power]: 10W  
 材质 [Material]: Die-cast aluminum+PC  
 开孔 [Cut Hole]:  $\Phi$ 100mm

光学角度/Beam  
  
 15° Narrow 24° Middle 38° Wide

芯片/Chip  
  
 科锐 (CREE) 西铁城 (CITIZEN) COB

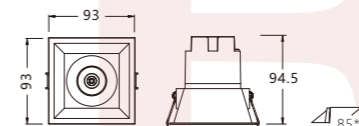
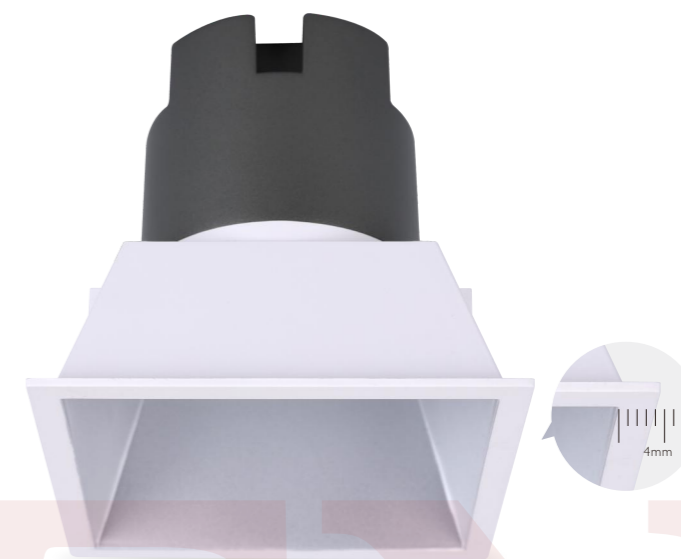
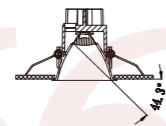

**TSD003-3F**  
 功率 [Power]: 10W  
 材质 [Material]: Die-cast aluminum+PC  
 开孔 [Cut Hole]: 85\*85mm

光学角度/Beam  
  
 15° Narrow 24° Middle 38° Wide

芯片/Chip  
  
 科锐 (CREE) 西铁城 (CITIZEN) COB

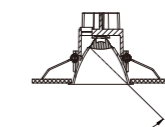

+866-18680577977

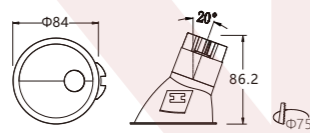
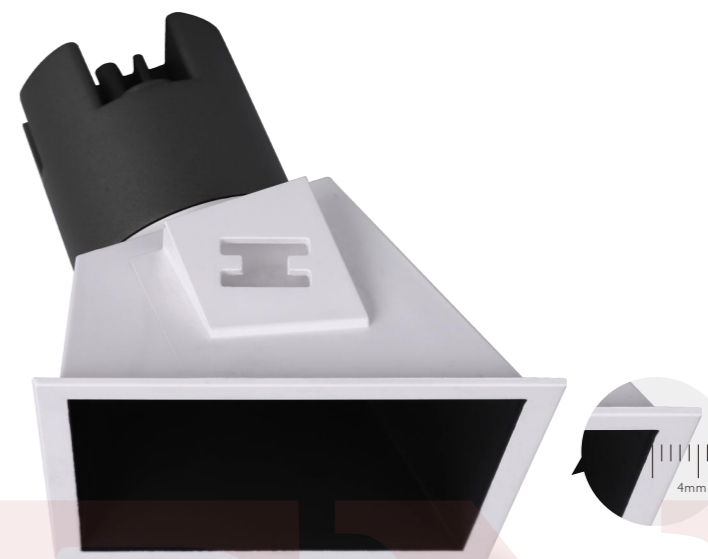

**TSD002X-2F**  
 功率 [Power]: 5W  
 材质 [Material]: Die-cast aluminum+PC  
 开孔 [Cut Hole]:  $\Phi$ 75mm

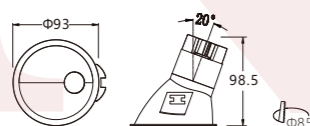

**TSD002X-3F**  
 功率 [Power]: 5W  
 材质 [Material]: Die-cast aluminum+PC  
 开孔 [Cut Hole]:  $\Phi$ 85mm

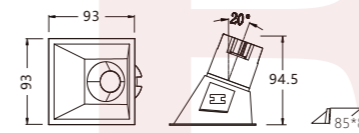

**TSD003X-3F**  
 功率 [Power]: 5W  
 材质 [Material]: Die-cast aluminum+PC  
 开孔 [Cut Hole]: 85\*85mm

光学角度/Beam

15° Narrow   24° Middle   38° Wide

芯片/Chip

科锐 (CREE)  
西铁城 (CITIZEN)  
COB

光学角度/Beam

15° Narrow   24° Middle   38° Wide

芯片/Chip

科锐 (CREE)  
西铁城 (CITIZEN)  
COB



+866-18680577977

IP54



AW-TD059-3F

功率 [Power]: 10W  
开孔 [Cutout]:  $\Phi 90\text{mm}$   
灯体 [Size]:  $\Phi 100 \times H 70\text{mm}$

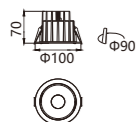

功率 [Power]: 20W  
开孔 [Cutout]:  $\Phi 130\text{mm}$   
灯体 [Size]:  $\Phi 140 \times H 85\text{mm}$

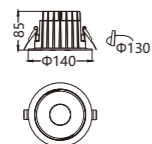

功率 [Power]: 30W  
开孔 [Cutout]:  $\Phi 170\text{mm}$   
灯体 [Size]:  $\Phi 185 \times H 112\text{mm}$

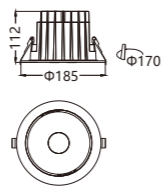

功率 [Power]: 40W  
开孔 [Cutout]:  $\Phi 200\text{mm}$   
灯体 [Size]:  $\Phi 230 \times H 128\text{mm}$

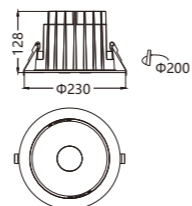

色温 [Color temp.]: 2700K | 3000K | 4000K | 5000K  
材质 [Material]: Die-Cast Aluminum+PC  
环境温度 [Temp.]:  $-20^{\circ}\text{C} \sim +50^{\circ}\text{C}$   
灯体颜色 [Body color]: WH

光学角度/Beam



芯片/Chip



反光杯颜色/Reflector



IP54



AW-MD005-3F

功率 [Power]: 10W  
灯体 [Size]:  $\Phi 82 \times H 106\text{mm}$



功率 [Power]: 20W  
灯体 [Size]:  $\Phi 115 \times H 120\text{mm}$

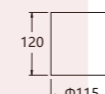

功率 [Power]: 30W  
灯体 [Size]:  $\Phi 149 \times H 143\text{mm}$

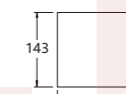

功率 [Power]: 40W  
灯体 [Size]:  $\Phi 187.5 \times H 159\text{mm}$

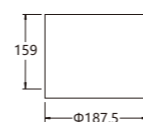

色温 [Color temp.]: 2700K | 3000K | 4000K | 5000K  
材质 [Material]: Die-Cast Aluminum+PC  
环境温度 [Temp.]:  $-20^{\circ}\text{C} \sim +50^{\circ}\text{C}$   
灯体颜色 [Body color]: WH | BK

光学角度/Beam

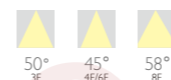

芯片/Chip



反光杯颜色/Reflector



+866-18680577977



A款/Trim



B款/Trim



A款/Trim



B款/Trim

AW-TD052-2.5F

功率 [Power]: 5W  
开孔 [Cutout]:  $\Phi 75$ mm  
灯体 [Size]:  $\Phi 90 \times H 56$ mm

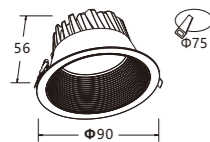

AW-TD052-3F

功率 [Power]: 9W  
开孔 [Cutout]:  $\Phi 90$ mm  
灯体 [Size]:  $\Phi 110 \times H 68$ mm

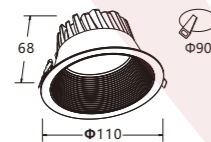

AW-TD052-4F

功率 [Power]: 15W  
开孔 [Cutout]:  $\Phi 120$ mm  
灯体 [Size]:  $\Phi 137.5 \times H 82$ mm

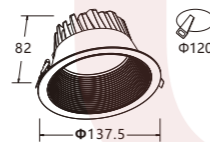

AW-TD052-5F

功率 [Power]: 20W  
开孔 [Cutout]:  $\Phi 140$ mm  
灯体 [Size]:  $\Phi 165 \times H 91$ mm

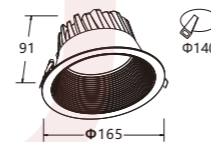

AW-TD052-6F

功率 [Power]: 30W  
开孔 [Cutout]:  $\Phi 170$ mm  
灯体 [Size]:  $\Phi 195 \times H 107$ mm

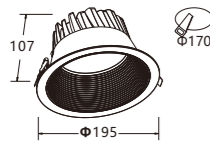

AW-TD052-8F

功率 [Power]: 40W  
开孔 [Cutout]:  $\Phi 200$ mm  
灯体 [Size]:  $\Phi 235 \times H 127.5$ mm

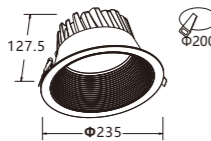

参数/Parameter

色温 [Color temp.]: 2700K | 3000K | 4000K | 5000K  
材质 [Material]: Die-Cast Aluminum  
环境温度 [Temp.]:  $-20^{\circ}\text{C} \sim +50^{\circ}\text{C}$   
灯体颜色 [Body color]: WH

芯片/Chip



SMD

AW-TD051-2.5F

功率 [Power]: 5W  
开孔 [Cutout]:  $\Phi 75$ mm  
灯体 [Size]:  $\Phi 90 \times H 56$ mm

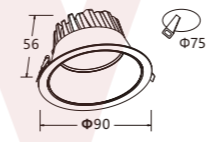

AW-TD051-3F

功率 [Power]: 9W  
开孔 [Cutout]:  $\Phi 90$ mm  
灯体 [Size]:  $\Phi 110 \times H 68$ mm

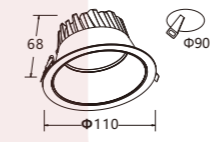

AW-TD051-4F

功率 [Power]: 15W  
开孔 [Cutout]:  $\Phi 120$ mm  
灯体 [Size]:  $\Phi 137.5 \times H 82$ mm

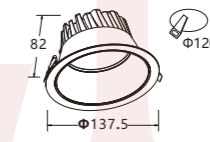

AW-TD051-5F

功率 [Power]: 20W  
开孔 [Cutout]:  $\Phi 140$ mm  
灯体 [Size]:  $\Phi 165 \times H 91$ mm

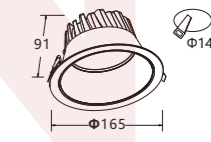

AW-TD051-6F

功率 [Power]: 30W  
开孔 [Cutout]:  $\Phi 170$ mm  
灯体 [Size]:  $\Phi 195 \times H 107$ mm

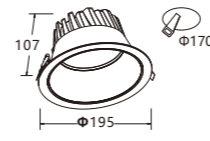

AW-TD051-8F

功率 [Power]: 40W  
开孔 [Cutout]:  $\Phi 200$ mm  
灯体 [Size]:  $\Phi 235 \times H 127.5$ mm

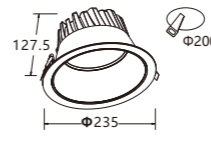

参数/Parameter

色温 [Color temp.]: 2700K | 3000K | 4000K | 5000K  
材质 [Material]: Die-Cast Aluminum  
环境温度 [Temp.]:  $-20^{\circ}\text{C} \sim +50^{\circ}\text{C}$   
灯体颜色 [Body color]: WH

光学角度/Beam



50° Wide

芯片/Chip



西铁城 (CITIZEN)  
COB

+8666-18680577977

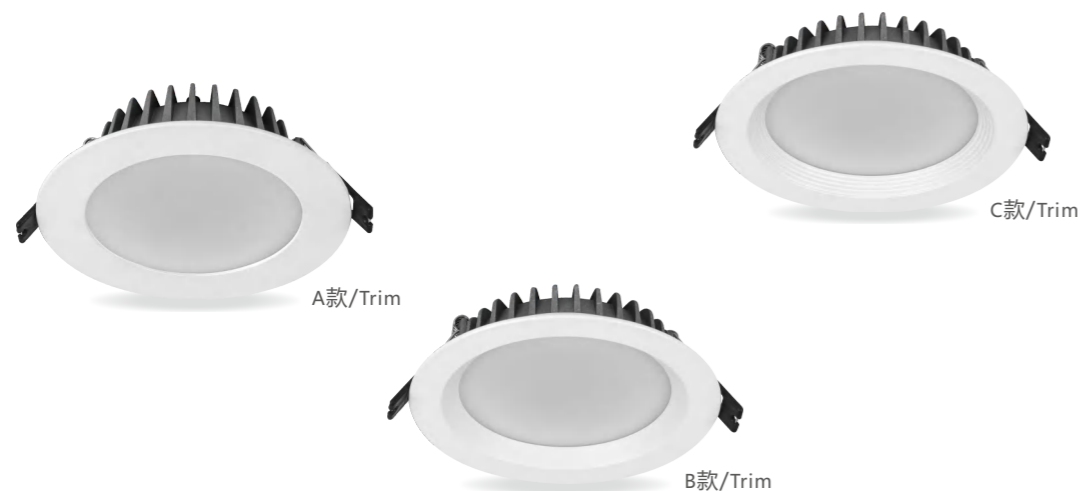

AW-TD055-2.5F

功率 [Power]: 3W  
开孔 [Cutout]:  $\Phi 70$ mm  
灯体 [Size]: A/ $\Phi 98 \times H 31$ mm  
B/C/ $\Phi 98 \times H 36$ mm



AW-TD055-3F

功率 [Power]: 5W  
开孔 [Cutout]:  $\Phi 80$ mm  
灯体 [Size]: A/ $\Phi 108 \times H 31$ mm  
B/C/ $\Phi 108 \times H 36$ mm



AW-TD055-3.5F

功率 [Power]: 7W  
开孔 [Cutout]:  $\Phi 90$ mm  
灯体 [Size]: A/ $\Phi 118 \times H 31.5$ mm  
B/C/ $\Phi 118 \times H 36$ mm

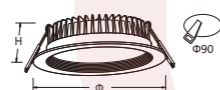

AW-TD055-4F

功率 [Power]: 9W  
开孔 [Cutout]:  $\Phi 115$ mm  
灯体 [Size]: A/ $\Phi 138 \times H 32$ mm  
B/C/ $\Phi 138 \times H 38.5$ mm



AW-TD056-2.5F

功率 [Power]: 5W  
开孔 [Cutout]:  $\Phi 70$ mm  
灯体 [Size]: A/ $\Phi 98 \times H 40$ mm  
B/C/ $\Phi 98 \times H 51$ mm



AW-TD056-3F

功率 [Power]: 7W  
开孔 [Cutout]:  $\Phi 80$ mm  
灯体 [Size]: A/ $\Phi 108 \times H 41$ mm  
B/C/ $\Phi 108 \times H 54$ mm



AW-TD056-3.5F

功率 [Power]: 9W  
开孔 [Cutout]:  $\Phi 90$ mm  
灯体 [Size]: A/ $\Phi 118 \times H 41$ mm  
B/C/ $\Phi 118 \times H 54$ mm

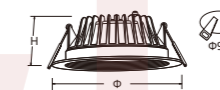

AW-TD056-4F

功率 [Power]: 12W  
开孔 [Cutout]:  $\Phi 115$ mm  
灯体 [Size]: A/ $\Phi 138 \times H 53$ mm  
B/C/ $\Phi 138 \times H 60$ mm



AW-TD055-5F

功率 [Power]: 12W  
开孔 [Cutout]:  $\Phi 155$ mm  
灯体 [Size]: A/ $\Phi 178 \times H 36$ mm  
B/C/ $\Phi 180 \times H 43.5$ mm

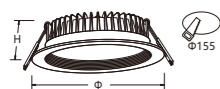

AW-TD055-6F

功率 [Power]: 20W  
开孔 [Cutout]:  $\Phi 160$ mm  
灯体 [Size]: A/ $\Phi 188 \times H 36$ mm  
B/C/ $\Phi 190 \times H 45$ mm

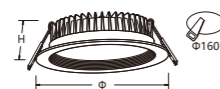

AW-TD055-8F

功率 [Power]: 30W  
开孔 [Cutout]:  $\Phi 210$ mm  
灯体 [Size]: A/ $\Phi 240 \times H 40$ mm  
B/C/ $\Phi 240 \times H 56$ mm

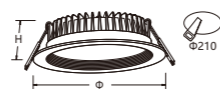

AW-TD056-5F

功率 [Power]: 15W  
开孔 [Cutout]:  $\Phi 155$ mm  
灯体 [Size]: A/ $\Phi 178 \times H 63$ mm  
B/C/ $\Phi 180 \times H 70$ mm



AW-TD056-6F

功率 [Power]: 20W  
开孔 [Cutout]:  $\Phi 160$ mm  
灯体 [Size]: A/ $\Phi 188 \times H 68$ mm  
B/C/ $\Phi 190 \times H 78$ mm



AW-TD056-8F

功率 [Power]: 30W  
开孔 [Cutout]:  $\Phi 210$ mm  
灯体 [Size]: A/ $\Phi 240 \times H 75$ mm  
B/C/ $\Phi 240 \times H 93$ mm

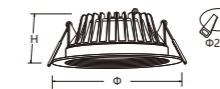

参数/Parameter

色温 [Color temp.]: 2700K | 3000K | 4000K | 5000K  
材质 [Material]: Aluminum+Die-Cast Aluminum  
环境温度 [Temp.]:  $-20^{\circ}\text{C} \sim +50^{\circ}\text{C}$   
灯体颜色 [Body color]: WH+GREY

芯片/Chip



参数/Parameter

色温 [Color temp.]: 2700K | 3000K | 4000K | 5000K  
材质 [Material]: Aluminum+Die-Cast Aluminum  
环境温度 [Temp.]:  $-20^{\circ}\text{C} \sim +50^{\circ}\text{C}$   
灯体颜色 [Body color]: WH+GREY

光学角度/Beam



芯片/Chip



+866-18680577977

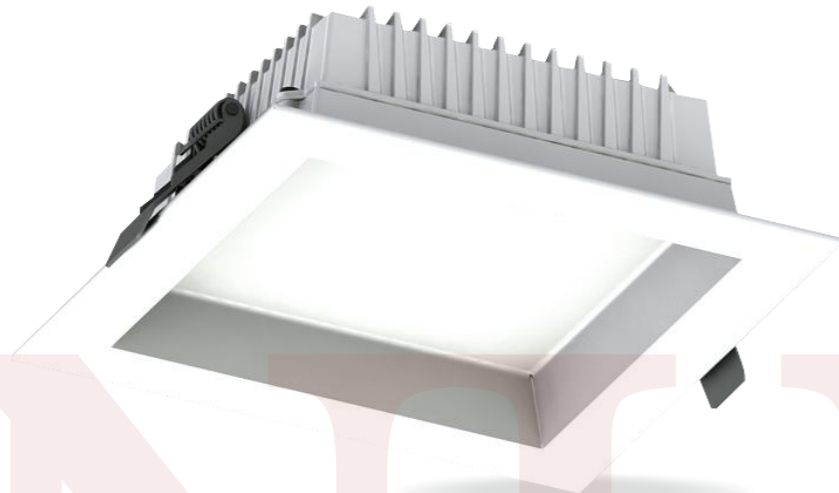

AW-TD058-4F

功率 [Power]: 12W  
 开孔 [Cutout]: L105×W105mm  
 灯体 [Size]: L120×W120×H51mm

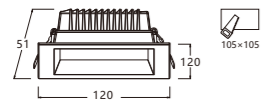

AW-TD058-6F

功率 [Power]: 20W  
 开孔 [Cutout]: L145×W145mm  
 灯体 [Size]: L167×W167×H54mm

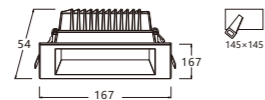

AW-TD058-8F

功率 [Power]: 25W  
 开孔 [Cutout]: L185×W185mm  
 灯体 [Size]: L215×W215×H55mm

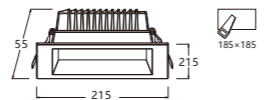

参数/Parameter

色温 [Color temp.]: 2700K | 3000K | 4000K | 5000K  
 材质 [Material]: Die-Cast Aluminum  
 环境温度 [Temp.]: -20°C~+50°C  
 灯体颜色 [Body color]: WH

芯片/Chip



TD053A



TD053B

AW-TD053-3F

功率 [Power]: 10W  
 开孔 [Cutout]:  $\Phi$ 95mm  
 灯体 [Size]:  $\Phi$ 110×H61mm

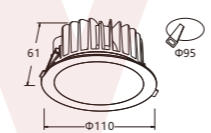

AW-TD053-4F

功率 [Power]: 15W  
 开孔 [Cutout]:  $\Phi$ 110mm  
 灯体 [Size]:  $\Phi$ 135×H69mm

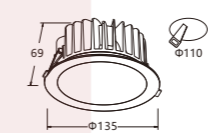

AW-TD053-5F

功率 [Power]: 25W  
 开孔 [Cutout]:  $\Phi$ 130mm  
 灯体 [Size]:  $\Phi$ 160×H75mm

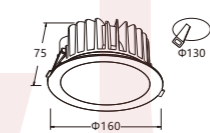

AW-TD053-6F

功率 [Power]: 40W  
 开孔 [Cutout]:  $\Phi$ 165mm  
 灯体 [Size]:  $\Phi$ 185×H100mm

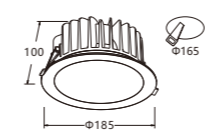

AW-TD053-8F

功率 [Power]: 60W  
 开孔 [Cutout]:  $\Phi$ 205mm  
 灯体 [Size]:  $\Phi$ 240×H120mm

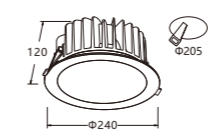

参数/Parameter

色温 [Color temp.]: 2700K | 3000K | 4000K | 5000K  
 材质 [Material]: Die-Cast Aluminum  
 环境温度 [Temp.]: -20°C~+50°C  
 灯体颜色 [Body color]: WH

光学角度/Beam



芯片/Chip



+866-18680577977



AW-TD065-2F

功率 [Power]: 5W  
开孔 [Cutout]:  $\Phi 75\text{mm}$   
灯体 [Size]:  $\Phi 80 \times H40\text{mm}$

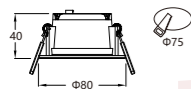

AW-TD065-3F

功率 [Power]: 7W  
开孔 [Cutout]:  $\Phi 85\text{mm}$   
灯体 [Size]:  $\Phi 96 \times H47\text{mm}$

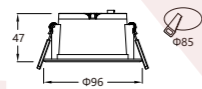

AW-TD065-3,5F

功率 [Power]: 9W  
开孔 [Cutout]:  $\Phi 100\text{mm}$   
灯体 [Size]:  $\Phi 113 \times H55\text{mm}$



AW-TD065-4F

功率 [Power]: 12W  
开孔 [Cutout]:  $\Phi 120\text{mm}$   
灯体 [Size]:  $\Phi 138 \times H64\text{mm}$

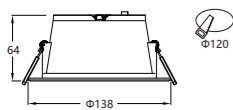

AW-TD065-5F

功率 [Power]: 15W  
开孔 [Cutout]:  $\Phi 140\text{mm}$   
灯体 [Size]:  $\Phi 165 \times H74\text{mm}$

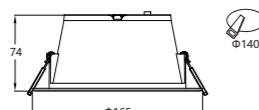

AW-TD065-6F

功率 [Power]: 20W  
开孔 [Cutout]:  $\Phi 170\text{mm}$   
灯体 [Size]:  $\Phi 195 \times H85\text{mm}$

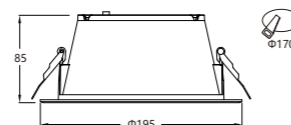

AW-TD065-8F

功率 [Power]: 30W  
开孔 [Cutout]:  $\Phi 200\text{mm}$   
灯体 [Size]:  $\Phi 228 \times H97\text{mm}$

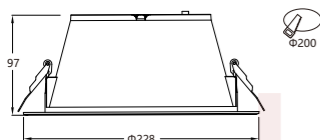

可选颜色/Optional Color



银色/SL 铬色/CH 白色/WH

光学角度/Beam



60° Flood

芯片/Chip

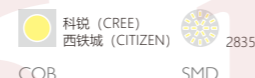

COB

SMD

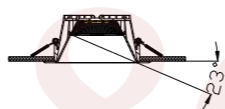

+866-18680577977

# TRACK

Light

轨道灯系列



GD003-D60

功率 [Power]: 10W  
灯体 [Size]:  $\Phi 60 \times H100\text{mm}$

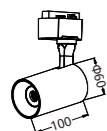

GD003-D80

功率 [Power]: 20W  
灯体 [Size]:  $\Phi 80 \times H120\text{mm}$

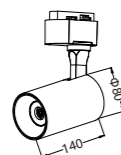

GD003-D90

功率 [Power]: 30W  
灯体 [Size]:  $\Phi 90 \times H140\text{mm}$

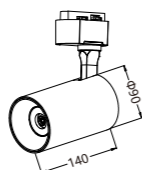

参数/Parameter

色温 [Color temp.]: 2700K | 3000K | 4000K | 5000K

材质 [Material]: Aluminum+PC

环境温度 [Temp.]:  $-20^{\circ}\text{C} \sim +50^{\circ}\text{C}$

灯体颜色 [Body color]: WH | BK

光学角度/Beam

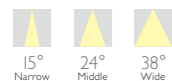

芯片/Chip

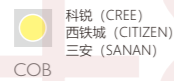

1866-1868057777