

CONTENTS

LED SHOWCASE LIGHT

Page.1-12

LED MAGNETIC TRACK SPOTLIGHT

Page.13-16

LED DOWN LIGHT

Page.17-26

LED ROTATABLE LIGHT

Page.27-28

LED MUSEUM AND GALLERY FOCUCS TRACK LIGHT

Page.29-30



NUWEN CO.,LTD

Add:Unit 1,no.187,Xiayang road,Hetang Town ,Pengjiang District,Jiangmen City,Guangdong Province , China.

E-mail: nuwen.china.2020@gmail.com

Mobile: +86-18680577977

WeChat/Whats app: +86-18680577977



Jewellery & Watch Lighting

No matter how beautiful the jewelry is, all jewelry need good light to foil it, and change its luster .

LED jewelry lights make perfect jewelry store. LED jewelry lamp light penetration, stereo sense is strong, can be at short range light projection of jewelry, to promote the level of the jewelry, great show the jewelry value. LED jewelry light no UV and IR of jewelry, itself will not result in a loss is the jewelry store best lamps and lanterns.



+86-18680577977

LED
LED SHOWCASE LIGHT



LED
LED SHOWCASE LIGHT



/CUT SIZE: $\varnothing 34\text{mm}/40\text{mm}/55\text{mm}$

PRODUCT COLOR: Silver Black White

/HOUSING: Aluminum

Model	Power	Cut size	Input Voltage	CRI	Beam Angle	Lumen	CCT
KL-SCL07301A	1w	$\varnothing 34\text{mm}$	AC85-265V 50-60Hz	90	10°/25°/45°/60°	80	2400-9000k
KL-SCL07301B	2w	$\varnothing 40\text{mm}$	AC85-265V 50-60Hz	90	10°/25°/45°/60°	160	2400-9000k
KL-SCL07301C	3w	$\varnothing 55\text{mm}$	AC85-265V 50-60Hz	90	10°/25°/45°/60°	240	2400-9000k



CUT SIZE: $\varnothing 45/50/65\text{mm}$

PRODUCT COLOR: Black White

HOUSING: Aluminum

- Adjustable focal length;

Model	Power	Input Voltage	CRI	Beam Angle	Lumen	CCT
KL-SCL07302A	3w	AC85-265V 50-60Hz	80/90	6-60°	240	2400-9000k
KL-SCL07302B	3w	AC85-265V 50-60Hz	80/90	6-60°	240	2400-9000k
KL-SCL07302C	7w	AC85-265V 50-60Hz	80/90	6-60°	560	2400-9000k



CUT SIZE: $\varnothing 45/50/65\text{mm}$

PRODUCT COLOR: Black White

HOUSING: Aluminum

- Focus the bulls-the eye spotlights
- Adjustable for dim and CCT

Model	Power	Input Voltage	CRI	Beam Angle	Lumen	CCT
KL-SCL07303A	3w	AC90-265V 50-60Hz	>85	10°-60°	85lm/w	2400-9000k
KL-SCL07303B	3w	AC90-265V 50-60Hz	>85	10°-60°	85lm/w	2400-9000k
KL-SCL07303C	7w	AC90-265V 50-60Hz	>85	10°-60°	85lm/w	2400-9000k



CUT SIZE: $\varnothing 40\text{mm}$

PRODUCT COLOR: Black White

HOUSING: Aluminum

- Focus the bulls-the eye spotlights
- Adjustable for dim and CCT

Model	Power	Input Voltage	CRI	Beam Angle	Lumen	CCT
KL-SCL07304	3w	AC90-265V 50-60Hz	>85	10°-60°	85lm/w	2400-9000k



CUT SIZE: $\varnothing 45/50/65\text{mm}$

PRODUCT COLOR: White Black

HOUSING: Aluminum

Model	Power	Input Voltage	CRI	Beam Angle	Lumen	CCT
KL-SCL07305	1-3w	AC100-240V 50-60Hz	85/92/97	25° /45° /60°	85lm/w	2400-9000k



CUT SIZE: $\varnothing 40\text{mm}$

PRODUCT COLOR: White Black

HOUSING: Aluminum

Model	Power	Input Voltage	CRI	Beam Angle	Lumen	CCT
KL-SL07306	1-3w	DC12V/DC24V AC85-265V	>85	25° /45° /60°	120lm	2400-9000k



LED
LED SHOWCASE LIGHT



LED
LED SHOWCASE LIGHT

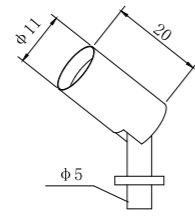
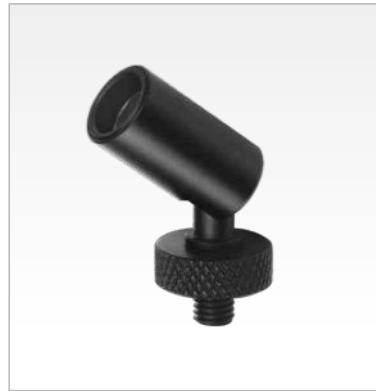

PRODUCT COLOR:

- Silver
- Black
- White

HOUSING:

- Aluminum

Model	Power	Input Voltage	CRI	Beam Angle	Lumen	CCT
KL-SCL07307	1w	AC85-265V 50-60Hz	90	15°/30°/45°	100	2400-9000k

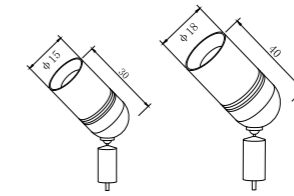
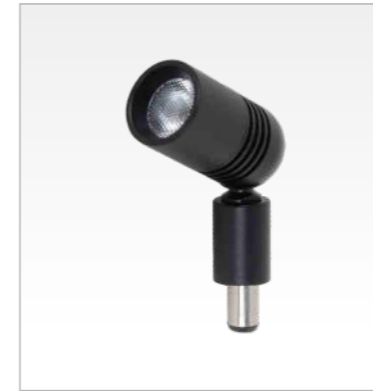

PRODUCT COLOR:

- White
- Black

HOUSING:

- Aluminum

Model	Power	Input Voltage	CRI	Beam Angle	Lumen	CCT
KL-SCL07309A	1w	AC100-240V 50-60Hz	85/92/97	25° /45° /60°	85lm/w	2400-9000k
KL-SCL07309B	3w	AC100-240V 50-60Hz	85/92/97	25° /45° /60°	85lm/w	2400-9000k

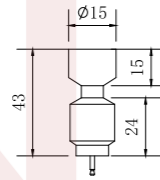

PRODUCT COLOR:

- White
- Black

HOUSING:

- Aluminum

Model	Power	Input Voltage	CRI	Beam Angle	Lumen	CCT
KL-SCL07308	1-3w	AC100-240V 50-60Hz	85/92/97	25° /45° /60°	85lm/w	2400-9000k

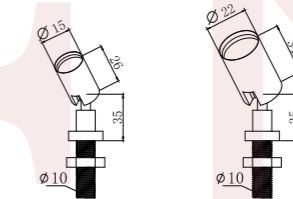

PRODUCT COLOR:

- White
- Black

HOUSING:

- Aluminum

Model	Power	Input Voltage	CRI	Beam Angle	Lumen	CCT
KL-SCL07310A	1w	AC100-240V 50-60Hz	85/92/97	25° /45° /60°	85lm/w	2400-9000k
KL-SCL07310B	1-3w	AC100-240V 50-60Hz	85/92/97	25° /45° /60°	85lm/w	2400-9000k



LED
LED SHOWCASE LIGHT



LED
LED SHOWCASE LIGHT

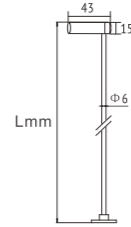

- PRODUCT COLOR:
 Silver Copper Golden Black
- HOUSING:
 Aluminum

Model	Power	Input Voltage	CRI	Beam Angle	Lumen	CCT
KL-SCL0102	1-2w	AC85-265V 50-60Hz	>85	12°/60°	160 (3000k)	2400-9000k

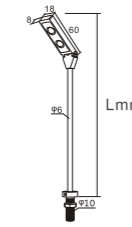

- PRODUCT COLOR:
 Silver Copper Golden Black
- HOUSING:
 Aluminum

Model	Power	Input Voltage	CRI	Beam Angle	Lumen	CCT
KL-SCL0502	2*1w	AC90-265V 50-60Hz	90	25°/45°/60°	220-280	2400-9000k

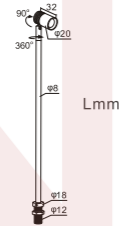

- PRODUCT COLOR:
 Silver Copper Golden Black
- HOUSING:
 Aluminum

Model	Power	Input Voltage	CRI	Beam Angle	Lumen	CCT
KL-SCL0103	1*3w	AC85-265V 50-60Hz	90	10°/25°/45°/60°	120-180	2400-9000k

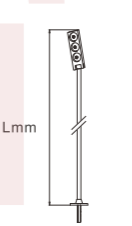

- PRODUCT COLOR:
 Silver Copper Golden Black
- HOUSING:
 Aluminum

Model	Power	Input Voltage	CRI	Beam Angle	Lumen	CCT
KL-SCL0503C	3*1w	AC90-265V 50-60Hz	>85	25°/45°/60°	300-390	2400-9000k
KL-SCL0503D	3*1w	AC85-265V 50-60Hz	>85	25°/45°/60°	300-390	2400-9000k

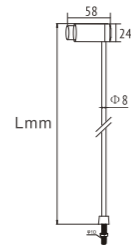

- PRODUCT COLOR:
 Silver Copper Golden Black
- HOUSING:
 Aluminum

• Focus adjustable stem showcase light

Model	Power	Input Voltage	CRI	Beam Angle	Lumen	CCT
KL-SCL0104	1*3w	AC85-265V 50-60Hz	90	10°/25°/45°/60°	120-180	2400-9000k

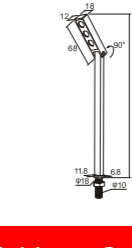

- PRODUCT COLOR:
 Silver Copper Golden Black
- HOUSING:
 Aluminum

Model	Power	Input Voltage	CRI	Beam Angle	Lumen	CCT
KL-SCL0503R	3*1w	AC85-265V 50-60Hz	>85	25°/45°/60°	300-390	2400-9000k





LED
LED SHOWCASE LIGHT

LED
LED SHOWCASE LIGHT



- PRODUCT COLOR:
 Silver Copper Golden Black
 HOUSING:
 Aluminum

Model	Power	Input Voltage	CRI	Beam Angle	Lumen	CCT
KL-SCL0504	3*1w	AC85-265V 50-60Hz	>85	12° /60°	220-280	2400-9000k



- PRODUCT COLOR:
 Silver Copper Golden Black
 HOUSING:
 Aluminum

Model	Power	Input Voltage	CRI	Beam Angle	Lumen	CCT
KL-SCL0701	1w	AC85-265V 50-60Hz	>85	12° /60°	220-280	2400-9000k

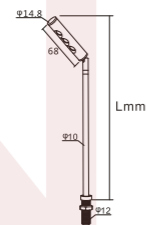

- PRODUCT COLOR:
 Silver Copper Golden Black
 HOUSING:
 Aluminum

Model	Power	Input Voltage	CRI	Beam Angle	Lumen	CCT
KL-SCL0703	3*1w	AC85-265V 50-60Hz	≥85	25°/45°/60°	300-390	2400-9000k

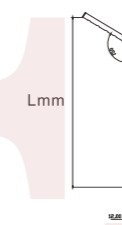

- PRODUCT COLOR:
 Silver Copper Golden Black
 HOUSING:
 Aluminum

Model	Power	Input Voltage	CRI	Beam Angle	Lumen	CCT
KL-SCL0704	3w	AC85-265V 50-60Hz	>85	12° /60°	248 (3000k)	2400-9000k

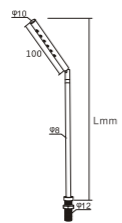

- PRODUCT COLOR:
 Silver Copper Golden Black
 HOUSING:
 Aluminum

Model	Power	Input Voltage	CRI	Beam Angle	Lumen	CCT
KL-SCL0702	6*0.5w	AC85-265V 50-60Hz	>85	60°	300-390	2400-9000k

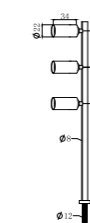

- PRODUCT COLOR:
 Silver Copper Golden Black
 HOUSING:
 Aluminum

Model	Power	Input Voltage	CRI	Beam Angle	Lumen	CCT
KL-SCL0302	3w	AC85-265V 50-60Hz	>85	12° /60°	248 (3000k)	2400-9000k



NUWEN +86-18680577977

LED
LED SHOWCASE LIGHT



LED
LED SHOWCASE LIGHT

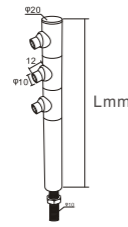

- PRODUCT COLOR:
 Silver Copper Golden Black
 HOUSING:
 Aluminum

Model	Power	Input Voltage	CRI	Beam Angle	Lumen	CCT
KL-SCL0301	3*1w	AC85-265V 50-60Hz	>85	25°/45°/60°	110lm/w	2400-9000k

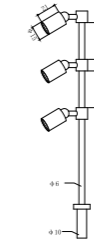

- PRODUCT COLOR:
 Silver Copper Golden Black
 HOUSING:
 Aluminum

Model	Power	Input Voltage	CRI	Beam Angle	Lumen	CCT
KL-SCL0305	3*1w	AC90-265V 50-60Hz	>85	15° /30° /45°	220	2400-9000k

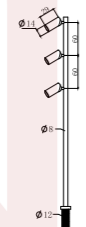

- PRODUCT COLOR:
 Silver Copper Golden Black
 HOUSING:
 Aluminum

Model	Power	Input Voltage	CRI	Beam Angle	Lumen	CCT
KL-SCL0303	3*1w	AC90-265V 50-60Hz	>85	12° /60°	248	2400-9000k

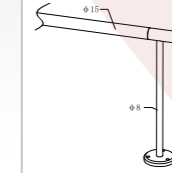
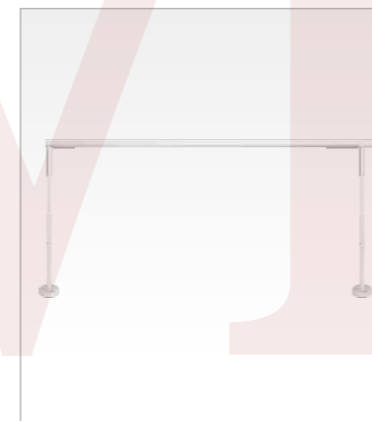

- PRODUCT COLOR:
 Silver Copper Golden Black
 HOUSING:
 Aluminum

Model	Power	Input Voltage	CRI	Beam Angle	Lumen	CCT
KL-SCL1120	18w/m	AC85-265V 50-60Hz	>85	120°	1500lm/m	2400-9000k

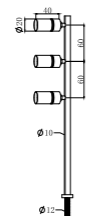

- PRODUCT COLOR:
 Silver Copper Golden Black
 HOUSING:
 Aluminum

Model	Power	Input Voltage	CRI	Beam Angle	Lumen	CCT
KL-SCL0304	3*1w	AC85-265V 50-60Hz	>85	12° /60°	220-280	2400-9000k

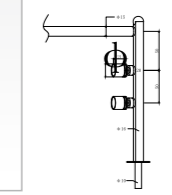
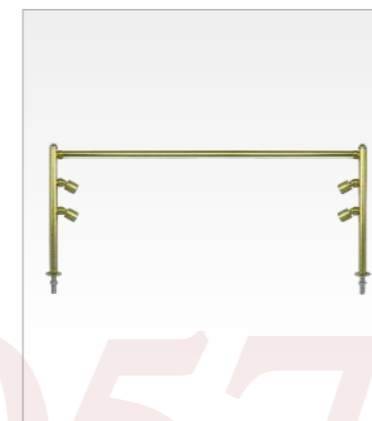

- PRODUCT COLOR:
 Silver Copper Golden Black
 HOUSING:
 Aluminum

Model	Power	Input Voltage	CRI	Beam Angle	Lumen	CCT
KL-SCL1121	18w/m	AC85-265V 50-60Hz	>85	12° /60°	1500lm/m	2400-9000k



+86-18680577977

LED
LED SHOWCASE LIGHT



LED
LED SHOWCASE LIGHT

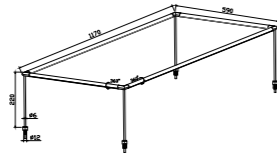

- PRODUCT COLOR:
 Silver Copper Golden Black
 HOUSING:
 Aluminum

Model	Power	Input Voltage	CRI	Beam Angle	Lumen	CCT
KL-SCL1119	22w/m	AC85-265V 50-60Hz	>85	12°/60°	1500lm/m	2400-9000k



- PRODUCT COLOR:
 Silver Black
 HOUSING:
 Aluminum

Model	Power	Input Voltage	CRI	Beam Angle	Lumen	CCT
KL-SCL1116	18w/m	DC12V/DC24V AC85-265V	>85	120°	1500lm/m	2400-9000k



Customized

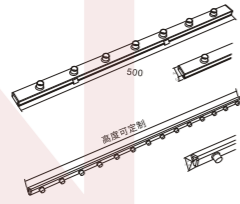
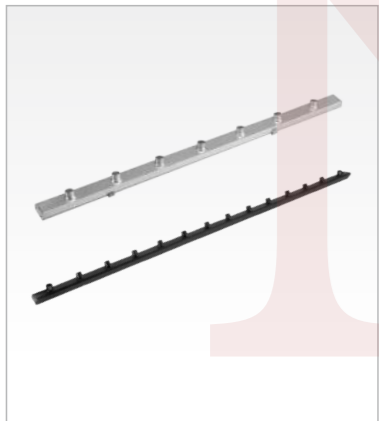

- PRODUCT COLOR:
 Silver Copper Golden Black
 HOUSING:
 Aluminum

Model	Power	Input Voltage	CRI	Beam Angle	Lumen	CCT
KL-SCL7301	7w	AC85-265V 50-60Hz	>85	25°/45°/60°	110lm/w	2400-9000k

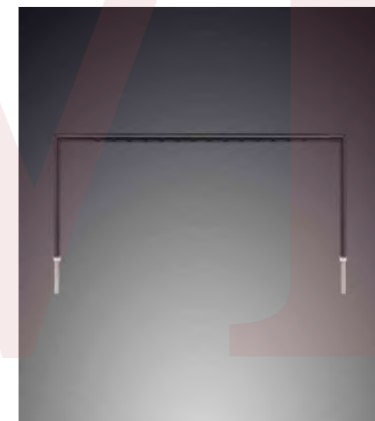

- One side luminescence and Three side luminescence are available for choice

- PRODUCT COLOR:
 Silver Black
 HOUSING:
 Aluminum

Model	Power	Input Voltage	CRI	Beam Angle	Lumen	CCT
KL-SCL1114	14*2w	DC24V AC85-265V	>85	15° /45° /60°	110lm/w	2400-9000k



Customized

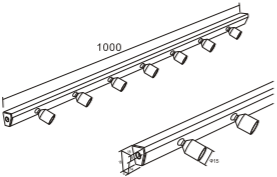

- PRODUCT COLOR:
 Silver
 HOUSING:
 Aluminum

Model	Power	Input Voltage	CRI	Beam Angle	Lumen	CCT
KL-SCL1117	7*1w	AC90-265V 50-60Hz	90	25°/45°/60°	110lm/w	2400-9000k

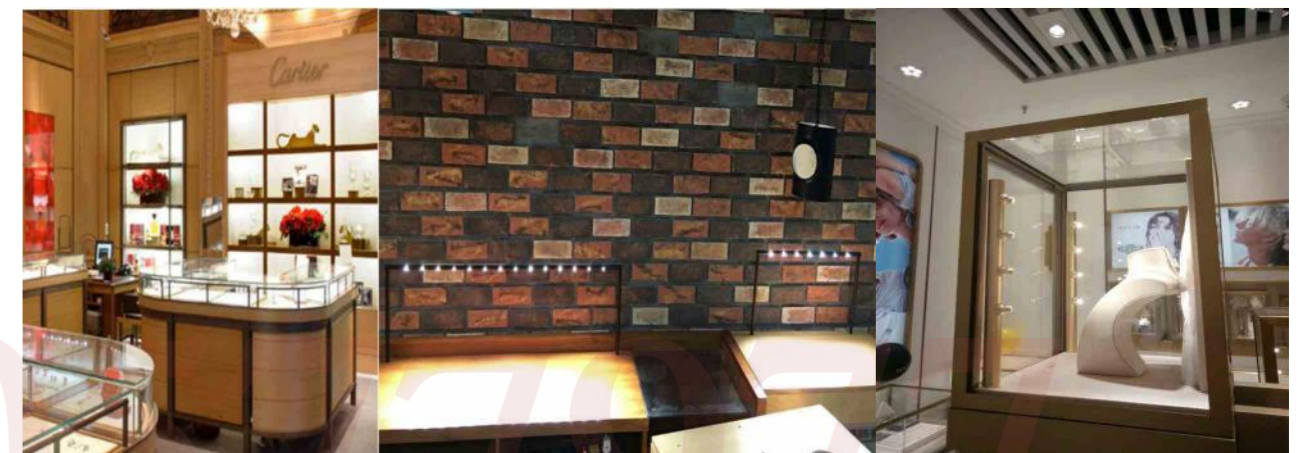

+86-18680577977



LED MAGNETIC MINI TRACK SPOTLIGHT

PRODUCT FEATURES

High quality LED chip, pure light and color, long spanlife. Adjustable rotation 300°, vertical 80°. Adopt high quality magnetic track bar, can install on all sorts of iron frame, magnetic small shot light can slide freely on iron base plate track.

APPLICATION

Jewelry cabinet, Clothing cabinet, display cabinet.

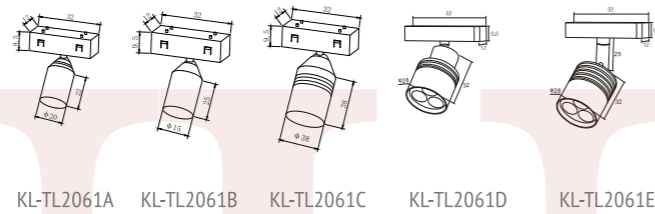

Application scenario



Magnet Track (Pin Contact)



Magnetic Track

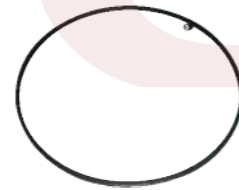

Driver



LED MAGNETIC MINI TRACK SPOTLIGHT

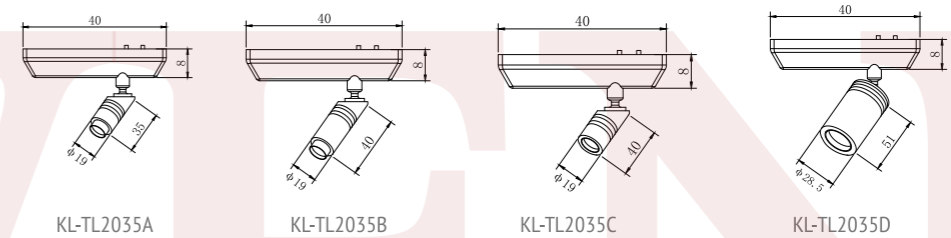

Application scenario



Horizontal Track



Vertical Track



Driver



PRODUCT COLOR:

Black Silver

HOUSING:

Aluminum

Model	Power	Input Voltage	CRI	Beam Angle	Lumen	CCT
KL-TL2061A	2w	DC12V	90	15°/30°/45°	130lm	3000K-6000K
KL-TL2061B	1w	DC12V	90	15°/30°/45°	110lm	3000K-6000K
KL-TL2061C	3w	DC12V	90	15°/30°/45°	165lm	3000K-6000K
KL-TL2061D	3*1w	DC12V	90	15°/30°/45°	280lm	3000K-6000K
KL-TL2061E	3*1w	DC12V	90	15°/30°/45°	280lm	3000K-6000K

PRODUCT COLOR:

Black Silver

HOUSING:

Aluminum

Model	Power	Input Voltage	CRI	Beam Angle	Lumen	CCT
KL-TL2035A	1w	DC12V	90	15°/30°/45°	90lm	3000K-6500K
KL-TL2035B	3w	DC12V/24V	90	15°/30°/45°	180lm	3000K-6000K
KL-TL2035C	3w	DC12V/24V	90	15°/25°/45°	165lm	3000K-6000K
KL-TL2035D	3w	DC12V/24V	90	15°/25°/45°	180lm	3000K-6000K

+86-18680577977



LED MAGNETIC MINI TRACK SPOTLIGHT

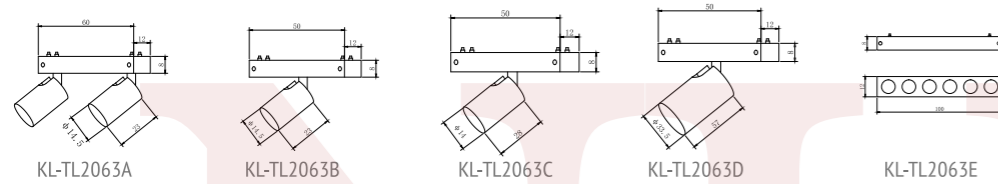

Application scenario

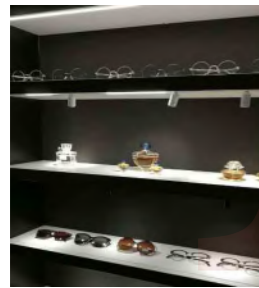

Track



Driver



PRODUCT COLOR:

- Black
- Silver

HOUSING:

- Aluminum

Model	Power	Input Voltage	CRI	Beam Angle	Lumen	CCT
KL-TL2063A	2w	DC12V/24V	90	15°/30°/45°	170lm	3000K-6500K
KL-TL2063B	1w	DC12V/24V	90	15°/30°/45°	95lm	3000K-6500K
KL-TL2063C	2w	DC12V/24V	90	15°/30°/45°	170lm	3000K-6500K
KL-TL2063D	5w	DC12V/24V	90	15°/30°/45°	400lm	3000K-6500K
KL-TL2063E	3w	DC12V/24V	90	15°/30°/45°	280lm	3000K-6500K

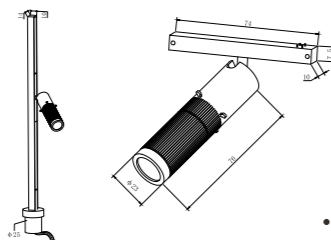

• Adjustable focal length ;

Model	Power	Input Voltage	CRI	Beam Angle	Lumen	CCT
KL-TL2065	2w	DC12V/24V	90	15°/30°/45°	170lm	3000K-6500K

PRODUCT COLOR:

- Black
- Silver

HOUSING:

- Aluminum

LED MAGNETIC MINI TRACK SPOTLIGHT

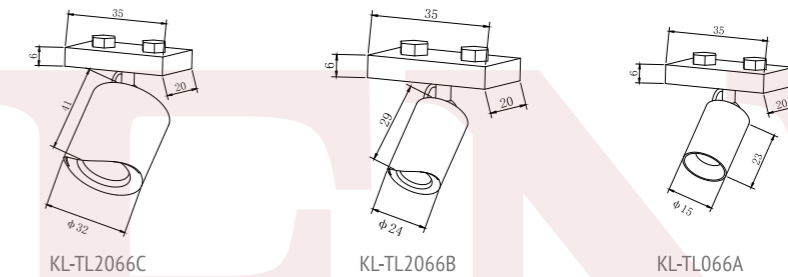

Application scenario



Horizontal Track

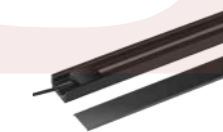

Driver



PRODUCT COLOR:

- Black
- Silver

HOUSING:

- Aluminum

Model	Power	Input Voltage	CRI	Beam Angle	Lumen	CCT
KL-TL2066A	1w	DC12V/24V	90	15°/30°/45°	110lm	3000K-6500K
KL-TL2066B	3w	DC12V/24V	90	15°/30°/45°	165lm	3000K-6500K
KL-TL2066C	5w	DC12V/24V	90	15°/30°/45°	420lm	3000K-6500K

+86-18680577977



LED
LED DOWN LIGHT

LED
LED DOWN LIGHT

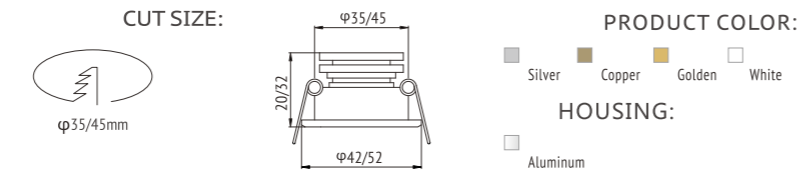

Model	Power	Input Voltage	CRI	Beam Angle	Lumen	CCT
KL-DL0601A	1-3w	AC90-265V 50-60Hz	85/92/97	12°/25°/30°/45°	85lm/w	2400-9000k
KL-DL0601	1*3w	AC90-265V 50-60Hz	85/92/97	12°/25°/30°/45°	85lm/w	2400-9000k

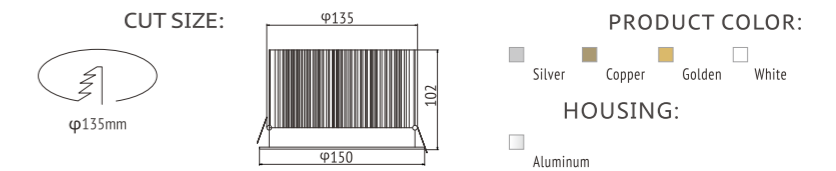

Model	Power	Input Voltage	CRI	Beam Angle	Lumen	CCT
KL-DL0612N	12*3w	AC90-265V 50-60Hz	85/92/97	12°/25°/30°/45°	86lm/w	2400-9000k
KL-DL0615T	15*3w	AC90-265V 50-60Hz	85/92/97	12°/25°/30°/45°	85lm/w	2400-9000k
KL-DL0624	30w	AC90-265V 50-60Hz	85/92/97	12°/25°/30°/45°	85lm/w	2400-9000k
KL-DL0630	36w	AC90-265V 50-60Hz	85/92/97	12°/25°/30°/45°	85lm/w	2400-9000k

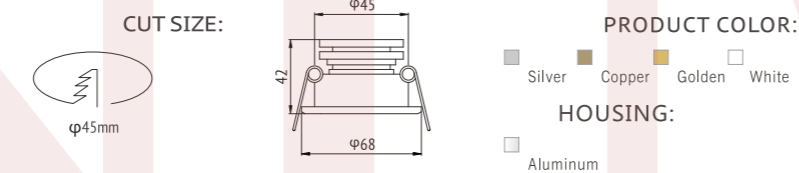

Model	Power	Input Voltage	CRI	Beam Angle	Lumen	CCT
KL-DL0603F	3*1w	AC90-265V 50-60Hz	85/92/97	12°/25°/30°/45°	85lm/w	2400-9000k

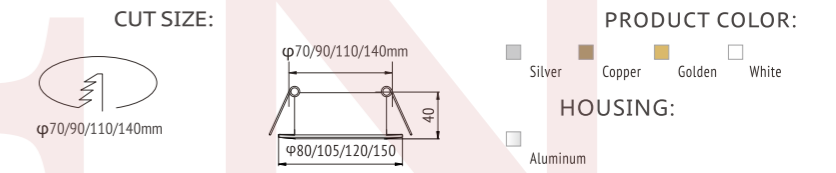

Model	Power	Input Voltage	CRI	Beam Angle	Lumen	CCT
KL-DL1303A	3w	AC100-240V 50-60Hz	85/92/97	15°/25°/45°/60°	90lm/w	2700-9000k
KL-DL1303B	7w	AC100-240V 50-60Hz	85/92/97	15°/25°/45°/60°	90lm/w	2700-9000k
KL-DL1303C	12w	AC100-240V 50-60Hz	85/92/97	15°/25°/45°/60°	90lm/w	2700-9000k
KL-DL1303D	18w	AC100-240V 50-60Hz	85/92/97	15°/25°/45°/60°	90lm/w	2700-9000k
KL-DL1303E	30w	AC100-240V 50-60Hz	85/92/97	15°/25°/45°/60°	90lm/w	2700-9000k

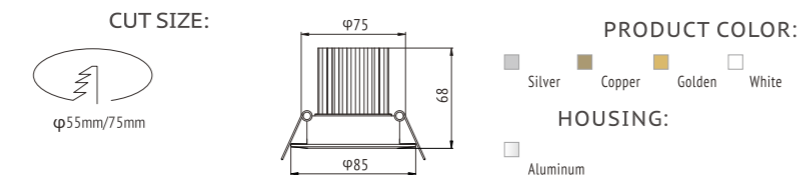

Model	Power	Input Voltage	CRI	Beam Angle	Lumen	CCT
KL-DL0603S	3*1w	AC90-265V 50-60Hz	80/90	12°/25°/30°/45°	85lm/w	2400-9000k
KL-DL0604S	3*3w	AC90-265V 50-60Hz	80/90	12°/25°/30°/45°	85lm/w	2400-9000k
KL-DL0605S	5*1w	AC90-265V 50-60Hz	80/90	12°/25°/30°/45°	85lm/w	2400-9000k

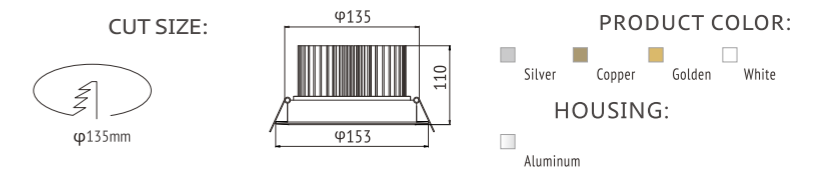

Model	Power	Input Voltage	CRI	Beam Angle	Lumen	CCT
KL-DL1018	18*3w	AC100-240V 50-60Hz	85/92/97	12°/25°/30°/45°	85lm/w	2700-9000k



+86-18680577977

LED
LED DOWN LIGHT

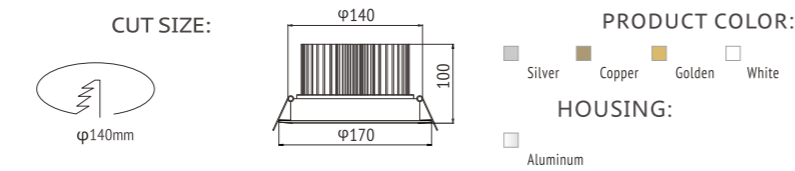

Model	Power	Input Voltage	CRI	Beam Angle	Lumen	CCT
KL-DL1019	40w	AC100-240V 50-60Hz	85/92/97	12°/25°/30°/45°	85lm/w	2700-9000k

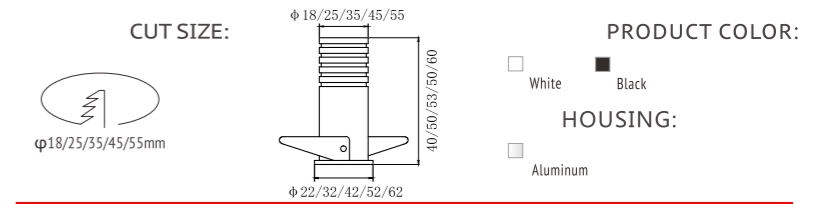

Model	Power	Input Voltage	CRI	Beam Angle	Lumen	CCT
KL-DL1320A	1-3w	AC90-265V 50/60Hz	≥85	5°/8°/10°/15° /24°/36°/45°	85lm/w	2700-9000k
KL-DL1320B	1-3w	AC90-265V 50/60Hz	≥85	8°/15° /24°/36°/45°	85lm/w	2700-9000k
KL-DL1320C	3-5w	AC90-265V 50/60Hz	≥85	5°/8°/15°/24° /36°/45°/60°	85lm/w	2700-9000k
KL-DL1320D	5-7w	AC90-265V 50/60Hz	≥85	8°/10° /15°/24°/36°	85lm/w	2700-9000k
KL-DL1320E	7-10w	AC90-265V 50/60Hz	≥85	8°/10° /15°/24°/36°	85lm/w	2700-9000k

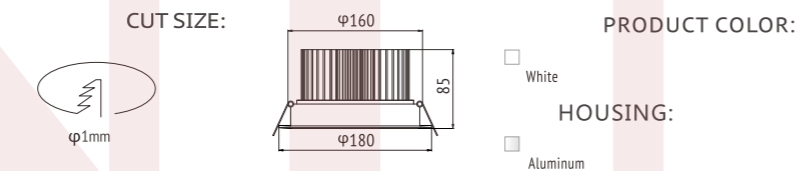
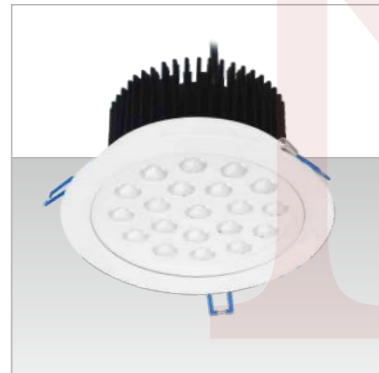

Model	Power	Input Voltage	CRI	Beam Angle	Lumen	CCT
KL-DL0620	20*2w	AC90-265V 50/60Hz	≥85	12°/25°/30°/45°	85lm/w	2400-9000k

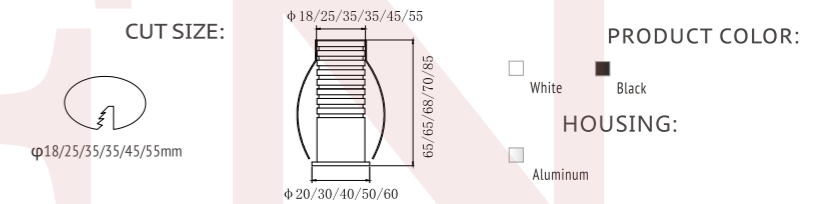

Model	Power	Input Voltage	CRI	Beam Angle	Lumen	CCT
KL-DL1321A	3-5w	AC90-265V 50/60Hz	≥85	5°/8°/10°/15° /24°/36°/45°/60°	85lm/w	2700-9000k
KL-DL1321B	3-5w	AC90-265V 50/60Hz	≥85	5°/8°/10°/15° /24°/36°/45°/60°	85lm/w	2700-9000k
KL-DL1321C	5-7w	AC90-265V 50/60Hz	≥85	5°/8°/10°/15° /24°/36°/45°/60°	85lm/w	2700-9000k
KL-DL1321D	7-9w	AC90-265V 50/60Hz	≥85	5°/8°/10°/15° /24°/36°/45°/60°	85lm/w	2700-9000k
KL-DL1321E	7-9w	AC90-265V 50/60Hz	≥85	10°/15°/24°/36°	85lm/w	2700-9000k
KL-DL1321F	9-12w	AC90-265V 50/60Hz	≥85	10°/15°/24°/36°	85lm/w	2700-9000k

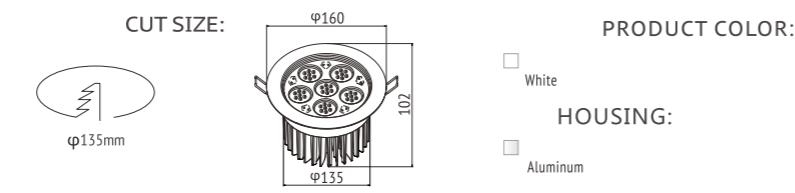

Model	Power	Input Voltage	CRI	Beam Angle	Lumen	CCT
KL-DL09A42	32w	AC90-265V 50/60Hz	≥85	15°/25°/45°	85lm/w	2700-9000k



LED
LED DOWN LIGHT



LED
LED DOWN LIGHT

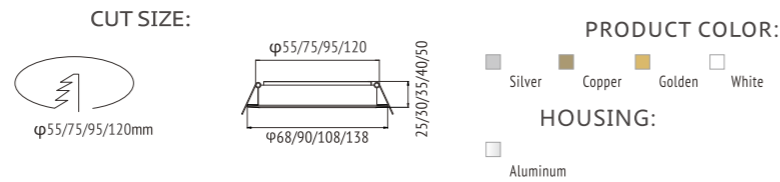

Model	Power	Input Voltage	CRI	Beam Angle	Lumen	CCT
KL-DL1322A	3w	AC85-265V 50-60Hz	90	10°/20°	240	2400-9000k
KL-DL1322B	5-7w	AC85-265V 50-60Hz	90	10°/20°/30°	560	2400-9000k
KL-DL1322C	10-15w	AC85-265V 50-60Hz	90	10°/20°/30°	1200	2400-9000k
KL-DL1322D	15-20w	AC85-265V 50-60Hz	90	10°/20°/30°	1600	2400-9000k
KL-DL1322E	20-25w	AC85-265V 50-60Hz	90	10°/20°/30°	1200	2400-9000k

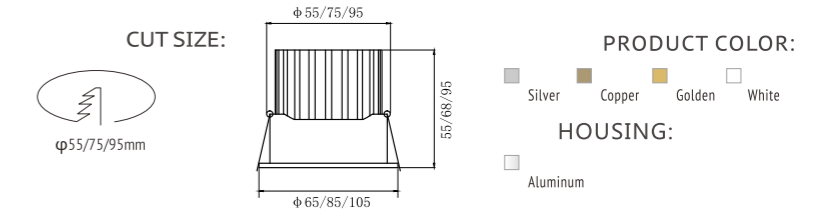

Model	Power	Input Voltage	CRI	Beam Angle	Lumen	CCT
KL-DL1325A	5-7w	AC90-265V 50-60Hz	85/92/97	12°/25°/30°/45°	85lm/w	2400-9000k
KL-DL1325B	10-12w	AC90-265V 50-60Hz	85/92/97	12°/25°/30°/45°	85lm/w	2400-9000k
KL-DL1325C	20-25w	AC90-265V 50-60Hz	85/92/97	12°/25°/30°/45°	85lm/w	2400-9000k

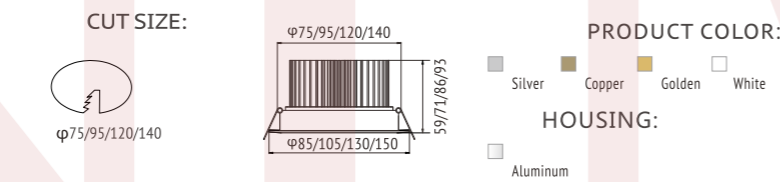

Model	Power	Input Voltage	CRI	Beam Angle	Lumen	CCT
KL-DL1323A	10-12w	AC90-265V 50-60Hz	85/92/97	15°/30°/45°	960lm	2700-9000k
KL-DL1323B	15-18w	AC90-265V 50-60Hz	85/92/97	15°/30°/45°	1440lm	2700-9000k
KL-DL1323C	20-25w	AC90-265V 50-60Hz	85/92/97	15°/30°/45°	2000lm	2700-9000k
KL-DL1323D	30-35w	AC90-265V 50-60Hz	85/92/97	15°/30°/45°	2800lm	2700-9000k

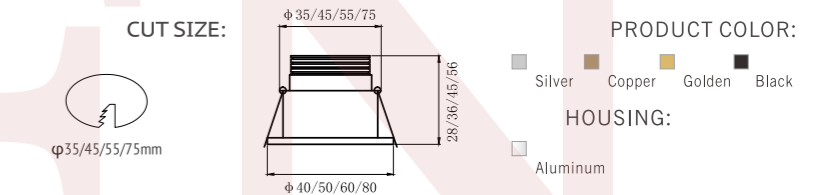

Model	Power	Input Voltage	CRI	Beam Angle	Lumen	CCT
KL-DL1326A	1-3w	AC85-265V 50-60Hz	>80	8°/10°/15°/24°/36°/40°/60°	85lm/w	2400-9000k
KL-DL1326B	3-5w	AC85-265V 50-60Hz	>80	5°/8°/10°/15°/24°/36°/40°/60°	85lm/w	2400-9000k
KL-DL1326C	7-9w	AC85-265V 50-60Hz	>80	3°/5°/8°/10°/15°/24°/36°/40°/60°	85lm/w	2400-9000k
KL-DL1326D	9-12w	AC85-265V 50-60Hz	>80	3°/5°/8°/10°/15°/24°/36°/40°/60°	85lm/w	2400-9000k

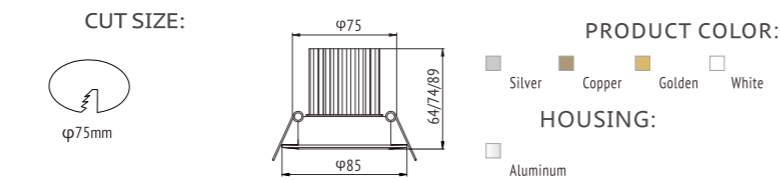

Model	Power	Input Voltage	CRI	Beam Angle	Lumen	CCT
KL-DL1324	8w/12w/15w	AC90-265V 50-60Hz	85/92/97	15°/25°/45°/60°	90lm/w	2700-9000k

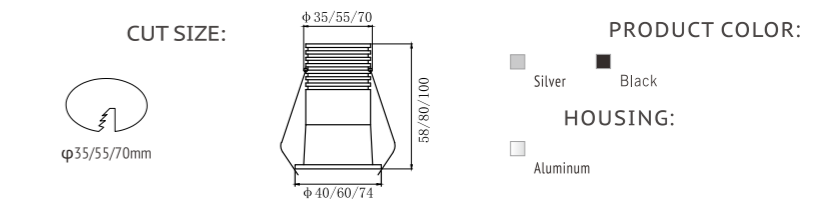

Model	Power	Input Voltage	CRI	Beam Angle	Lumen	CCT
KL-DL1327A	5w	DC12V/DC24V AC85-265V	>85	15°/24°/36°	120lm	2400-9000k
KL-DL1327B	10w	DC12V/DC24V AC85-265V	>85	15°/24°/36°	120lm	2400-9000k
KL-DL1327C	18w	DC12V/DC24V AC85-265V	>85	15°/24°/36°	120lm	2400-9000k



+86-1868057777



LED
LED DOWN LIGHT

LED
LED DOWN LIGHT

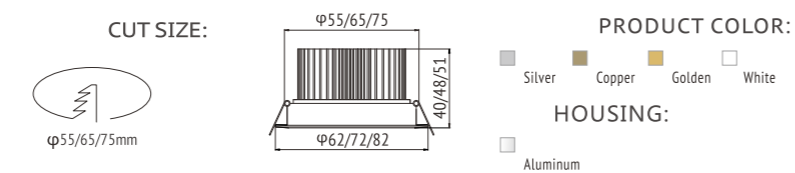

Model	Power	Input Voltage	CRI	Beam Angle	Lumen	CCT
KL-DL1328A	5-7w	AC100-240V 50-60Hz	85/92/97	15°/24°/36°	90lm/w	2700-9000k
KL-DL1328B	7-9w	AC100-240V 50-60Hz	85/92/97	15°/24°/36°	90lm/w	2700-9000k
KL-DL1328C	9-12w	AC100-240V 50-60Hz	85/92/97	15°/24°/36°	90lm/w	2700-9000k

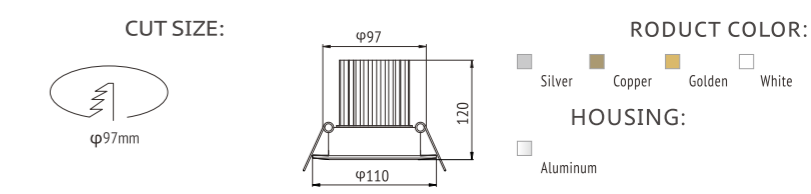

Model	Power	Input Voltage	CRI	Beam Angle	Lumen	CCT
KL-DL09008T	35w (COB)	AC100-240V 50-60Hz	85/92/97	15°/25°/45°/60°	90lm/w	2700-9000k

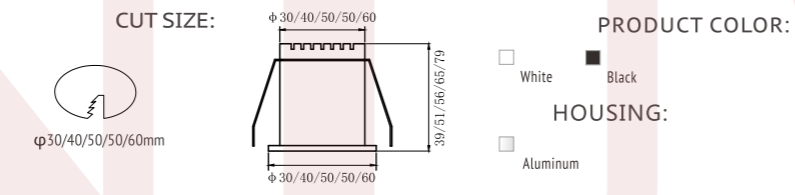

Model	Power	Input Voltage	CRI	Beam Angle	Lumen	CCT
KL-DL1329A	1-3w	AC90-265V 50/60Hz	≥85	8°/15°/24° /36°/45°/60°	85lm/w	2700-9000k
KL-DL1329B	1-5w	AC90-265V 50/60Hz	≥85	15°/24°/36°/55°	85lm/w	2700-9000k
KL-DL1329C	5-7w	AC90-265V 50/60Hz	≥85	15°/24°/36°	85lm/w	2700-9000k
KL-DL1329D	7-9w	AC90-265V 50/60Hz	≥85	15°/24°/36°	85lm/w	2700-9000k
KL-DL1329E	7-9w	AC90-265V 50/60Hz	≥85	15°/24°	85lm/w	2700-9000k

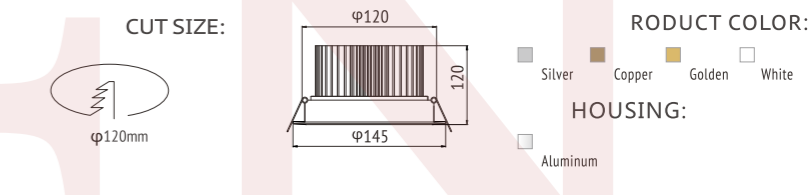

Model	Power	Input Voltage	CRI	Beam Angle	Lumen	CCT
KL-DL1013	40w	AC100-240V 50-60Hz	85/92/97	12°/25°/30°/45°	90lm/w	2700-9000k





LED
LED DOWN LIGHT



CUT SIZE:

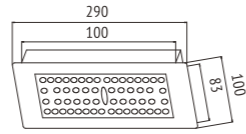
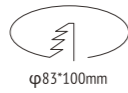

PRODUCT COLOR:

- Silver
- Copper
- Golden
- White

HOUSING:

- Aluminum

Model	Power	Input Voltage	CRI	Beam Angle	Lumen	CCT
KL-DL0910	40w	AC100-240V 50-60Hz	90	15°/25°/45°/60°	3393lm	2400-9000k



LED
LED DOWN LIGHT

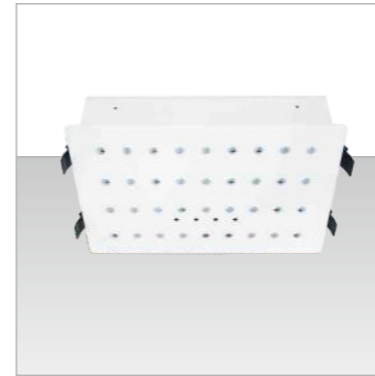

CUT SIZE:

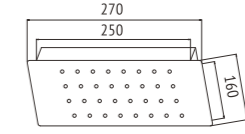

PRODUCT COLOR:

- White

HOUSING:

- Aluminum

• Adjustable for dim and CCT

Model	Power	Input Voltage	CRI	Beam Angle	Lumen	CCT
KL-DL0936A	46w	AC90-265V 50/60Hz	≥85	15°/25°/45°	85lm/w	2700-9000k



CUT SIZE:

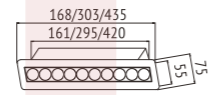

PRODUCT COLOR:

- White

HOUSING:

- Aluminum

Model	Power	Input Voltage	CRI	Beam Angle	Lumen	CCT
KL-DL0911A	5*2w	AC100-240V 50-60Hz	85/92/97	15°	85lm/w	2400-9000k
KL-DL0911B	10*2w	AC100-240V 50-60Hz	85/92/97	15°	85lm/w	2400-9000k
KL-DL0911C	15*2w	AC100-240V 50-60Hz	85/92/97	15°	85lm/w	2400-9000k

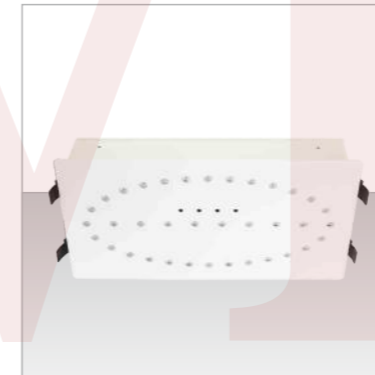

CUT SIZE:

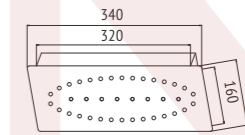

PRODUCT COLOR:

- White

HOUSING:

- Aluminum

• Adjustable for dim and CCT

Model	Power	Input Voltage	CRI	Beam Angle	Lumen	CCT
KL-DL0936B	46w	AC90-265V 50/60Hz	≥85	15°/25°/45°	85lm/w	2700-9000k



CUT SIZE:

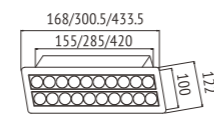

PRODUCT COLOR:

- White

HOUSING:

- Aluminum

Model	Power	Input Voltage	CRI	Beam Angle	Lumen	CCT
KL-DL0912A	10*2w	AC100-240V 50-60Hz	85/92/97	15°	85lm/w	2400-9000k
KL-DL0912B	20*2w	AC100-240V 50-60Hz	85/92/97	15°	85lm/w	2400-9000k
KL-DL0912C	30*2w	AC100-240V 50-60Hz	85/92/97	15°	85lm/w	2400-9000k





LED ROTATABLE LIGHT

PRODUCT COLOR:

White

HOUSING:

Aluminum



KL-RL0117



KL-RL0118



KL-RL0119



KL-RL0120

PRODUCT FEATURES

The rotatable design makes your showroom more dynamic and the different colors can give you the different atmosphere. Besides, high lumen, high CRI, no ultraviolet radiation. Be equipped with the high transparency of the optical lenses. Moreover, it is energy-saving, environment-friendly and easy to install.

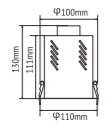

KL-RL0117

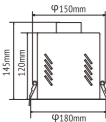

KL-RL0118

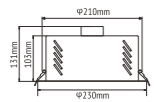

KL-RL0119

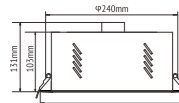

KL-RL0120

Model	Power	CRI	Beam Angle	Lumen	Rotatable (r/min)	CCT
KL-RL0117	15w	>85	24°	1200	12-15r/min	2pcs Blue,2pcs Red ,2pcs Green , Other CCT can be customized
KL-RL0118	21w	>85	24°	1680	12-15r/min	1pcs Yellow,1pcs Blue,1pcs Red ,1pcs Green , Other CCT can be customized
KL-RL0119	28w	>85	24°	2240	12-15r/min	2pcs Blue,2pcs Red ,2pcs Green , Other CCT can be customized
KL-RL0120	32w	>85	24°	2560	12-15r/min	2pcs Blue,2pcs Red ,2pcs Green , Other CCT can be customized

Input Voltage	Output Voltage
AC100-240V for lights 110Vac for motor AC200-240V for lights ,220Vac for motor	21-36V
AC100-240V for lights 110Vac for motor AC200-240V for lights ,220Vac for motor	21-36V
AC100-240V for lights 110Vac for motor AC200-240V for lights ,220Vac for motor	21-36V
AC100-240V for lights 110Vac for motor AC200-240V for lights ,220Vac for motor	21-36V



LED ROTATABLE LIGHT

PRODUCT COLOR:

White

Black

HOUSING:

Aluminum



KL-RL0121



KL-RL0122



KL-RL0123

PRODUCT FEATURES

The rotatable design makes your showroom more dynamic and the different colors can give you the different atmosphere. Besides, high lumen, high CRI, no ultraviolet radiation. Be equipped with the high transparency of the optical lenses. Moreover, it is energy-saving, environment-friendly and easy to install.

Model	Power	CRI	Beam Angle	Lumen	Rotatable (r/min)
KL-RL0121	15w	>85	24°	80lm/w	12-15r/min
KL-RL0122	15-32w	>85	24°	80lm/w	12-15r/min
KL-RL0123	15-32w	>85	24°	80lm/w	12-15r/min

CCT	Input Voltage	Output Voltage
2400-9000k	AC100-240V for lights 110Vac for motor AC200-240V for lights ,220Vac for motor	21-36V
1pcs Yellow,1pcs Blue,1pcs Red ,1pcs Green , Other CCT can be customized	AC100-240V for lights 110Vac for motor AC200-240V for lights ,220Vac for motor	21-36V
1pcs Yellow,1pcs Blue,1pcs Red ,1pcs Green , Other CCT can be customized	AC100-240V for lights 110Vac for motor AC200-240V for lights ,220Vac for motor	21-36V



LED

LED MUSEUM AND GALLERY FOCUCS TRACK LIGHT



PRODUCT FEATURES

The design is innovative, fashionable, energy-saving and environment-friendly. Easy installation and monopoly sales. It is a cool source light. Besides, it will not heat up indoors owing to using for a long time. The light shone on the goods can keep shiny and gorgeous.

APPLICATION

Shop, hotel, casual clubs, cabinet, clothing stores, etc.

- Optional: ceiling installation (track free), 2-lined track head, 3-lined track head, 4-lined track head.



PRODUCT COLOR: White Black

HOUSING: Aluminum

Model	Power	Input Voltage	CRI	Beam Angle	Lumen	CCT
KL-TL2361ST-10W	10w	AC90-265V 50/60Hz	≥97	20°-36° 15°-25°	300-350lm	2700-4000k
KL-TL2361ST-20W	20w	AC90-265V 50/60Hz	≥97	20°-36° 15°-25°	900-950lm	2700-4000k
KL-TL2361ST-28W	28w	AC90-265V 50/60Hz	≥97	20°-36° 15°-25°	1100-1300lm	2700-4000k
KL-TL2361ST-37W	37w	AC90-265V 50/60Hz	≥97	20°-36° 15°-25°	1400-1550lm	2700-4000k

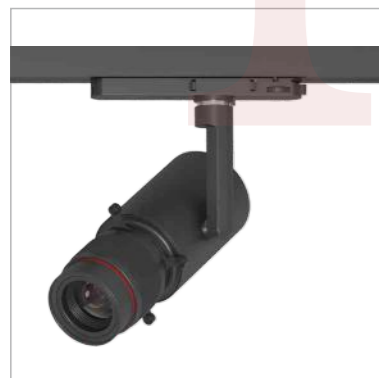

PRODUCT COLOR: White Black

HOUSING: Aluminum

Model	Power	Input Voltage	CRI	Beam Angle	Lumen	CCT
KL-TL2362ST-10W	10w	AC90-265V 50/60Hz	≥97	55°	300-350lm	2700-4000k
KL-TL2362ST-20W	20w	AC90-265V 50/60Hz	≥97	55°	770-800lm	2700-4000k
KL-TL2362ST-28W	28w	AC90-265V 50/60Hz	≥97	55°	1100-1200lm	2700-4000k
KL-TL2362ST-37W	37w	AC90-265V 50/60Hz	≥97	55°	1350-1450lm	2700-4000k

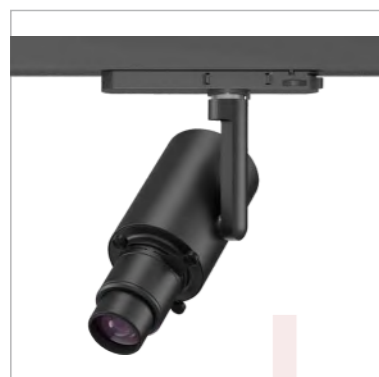

PRODUCT COLOR: White Black

HOUSING: Aluminum

Model	Power	Input Voltage	CRI	Beam Angle	Lumen	CCT
KL-TL2363ST-10W	10w	AC90-265V 50/60Hz	≥97	55°/15°-36°	300-350lm	2700-4000k
KL-TL2363ST-20W	20w	AC90-265V 50/60Hz	≥97	55°/15°-36°	745-780lm 630-650lm	2700-4000k
KL-TL2363ST-28W	28w	AC90-265V 50/60Hz	≥97	55°/15°-36°	1050-1150lm 870-1000lm	2700-4000k
KL-TL2363ST-37W	37w	AC90-265V 50/60Hz	≥97	55°/15°-36°	1110-1200lm 1100-1200lm	2700-4000k

LED

LED MUSEUM AND GALLERY FOCUCS TRACK LIGHT



PRODUCT COLOR: White Black

HOUSING: Aluminum

Model	Power	Input Voltage	CRI	Beam Angle	Lumen	CCT
KL-TL2364ST-3W	3w	AC90-265V 50/60Hz	≥97	55°/15°-36°	70-75lm 35-45lm	2700-4000k
KL-TL2364ST-5W	5w	AC90-265V 50/60Hz	≥97	55°/15°-36°	145-160lm 100-140lm	2700-4000k
KL-TL2364ST-10W	10w	AC90-265V 50/60Hz	≥97	55°/15°-36°	300-350lm	2700-4000k

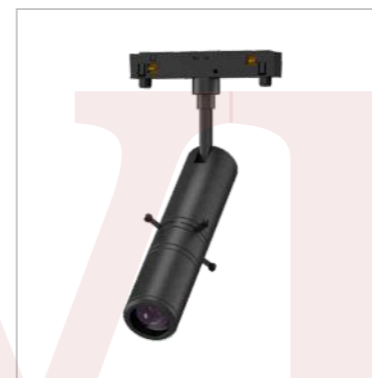

PRODUCT COLOR: White Black

HOUSING: Aluminum

Model	Power	Input Voltage	CRI	Beam Angle	Lumen	CCT
KL-TL2365ST-10W	10w	AC90-265V 50/60Hz	≥97	55°/15°-36°	300-350lm	2700-4000k



CUT SIZE: $\varnothing 25\text{mm}/25\text{mm}/40\text{mm}$

PRODUCT COLOR: White Black

HOUSING: Aluminum

Model	Power	Input Voltage	CRI	Beam Angle	Lumen	CCT
KL-TL2366ST-3W	3w	AC90-265V 50/60Hz	≥97	55°/15°-36°	70-75lm 34-35lm	2700-4000k
KL-TL2366ST-5W	5w	AC90-265V 50/60Hz	≥97	55°/15°-36°	145-160lm 100-140lm	2700-4000k
KL-TL2366ST-10W	10w	AC90-265V 50/60Hz	≥97	55°/15°-36°	300-350lm	2700-4000k



CUT SIZE: $\varnothing 75\text{mm}/95\text{mm}/125\text{mm}$

PRODUCT COLOR: White Black

HOUSING: Aluminum

Model	Power	Input Voltage	CRI	Beam Angle	Lumen	CCT
KL-TL2367ST-10W	10w	AC90-265V 50/60Hz	≥97	55°/15°-36°	300-350lm	2700-4000k
KL-TL2367ST-20W	20w	AC90-265V 50/60Hz	≥97	55°/15°-36°	745-780lm 630-650lm	2700-4000k
KL-TL2367ST-28W	28w	AC90-265V 50/60Hz	≥97	55°/15°-36°	1050-1150lm 870-1000lm	2700-4000k