

NUWEN
NUWEN

NUWEN
SOLAR LIGHT

NUWEN

NUWEN
SOLAR LIGHT

NUWEN CO.,LTD
ADD:UNIT 1,NO.187,XIAYANG ROAD,HETANG TOWN PENGJIANG
DISTRICT,JIANGMEN CITY,GUANGDONG
PROVINCE,CHINA.
E-EMAIL: NUWEN.CHINA.2020@GMAIL.COM
MOBILE :+86-18680577977
WECHAT/WHATS APP: +86-18680577977



NUWEN CO.,LTD

+86-18680577977



NUWEN
SOLAR LIGHT



NUWEN CO.,LTD



DIRECTORY 目录

01

Aluminium Solar street light with infrared induction sensor series
一体化太阳能路灯·铝型材带感应系列

Intergrated Solar Garden Lamp
别墅太阳能庭院灯

Country Road Solar Street Lamp Series
一体化太阳能路灯·乡村道路系列

Mainroad Solar Street lamp with Aluminium body series
一体化太阳能路灯·主干道路系列

Movable Mounted integrated solar street lamp
一体化太阳能路灯·活动直套筒系列

Intergrated Solar Street Light for Parking Lot/Square
一体化太阳能路灯·广场停车场高杆灯

Movable Mounted integrated solar street lamp
一体化太阳能路灯·活动直套筒系列

High power with infrared induction sensor series
一体化太阳能路灯·巨无霸感应系列

Camer Monitoring Solar street lamp Series
一体化太阳能路灯·摄像头监控系列

Camer Monitoring Solar street lamp Series
一体化太阳能路灯·摄像头监控系列

Wind and photovoltaic hybrid power series
一体化太阳能路灯·风光互补系列

Plastic Solar street light with infrared induction sensor
太阳能路灯·塑料感应系列

Villa Solar Street Lamp
别墅太阳能路灯

Country Road Solar Steet Lamp Series
乡村道路太阳能路灯系列

Solar flood light
太阳能投光灯系列



NUWEN
SOLAR LIGHT

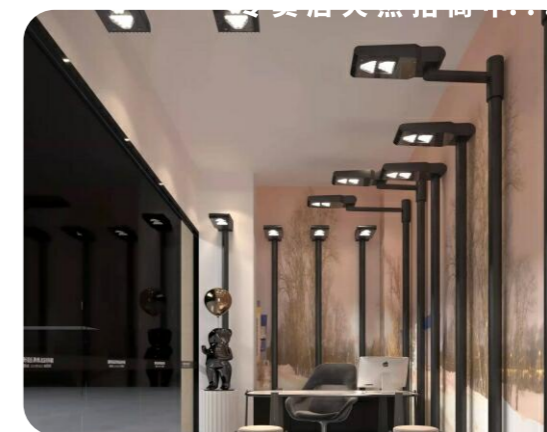

NUWEN CO.,LTD
ADD:UNIT 1,NO.187,XIAYANG ROAD,HETANG TOWN PENGJIANG,
DISTRICT,JIANGMEN CITY,GUANGDONG , PROVINCE,CHINA.

E-EMAIL: 1146156552@QQ.COM
MOBILE :+86-18680577977
WECHAT/WHATS APP: +86-18680577977



LIGHTING 365 DAYS
365天亮灯
户外防雨
 OUTDOOR WATERPROOF
 LIGHTING UP LIFE

Aluminium Solar street light with infrared induction sensor series



Human Intelligence Induction

When someone enters the infrared induction sensor area, it will turn on the full brightness mode. And it will automatically return to 30% brightness when someone left the infrared induction area.

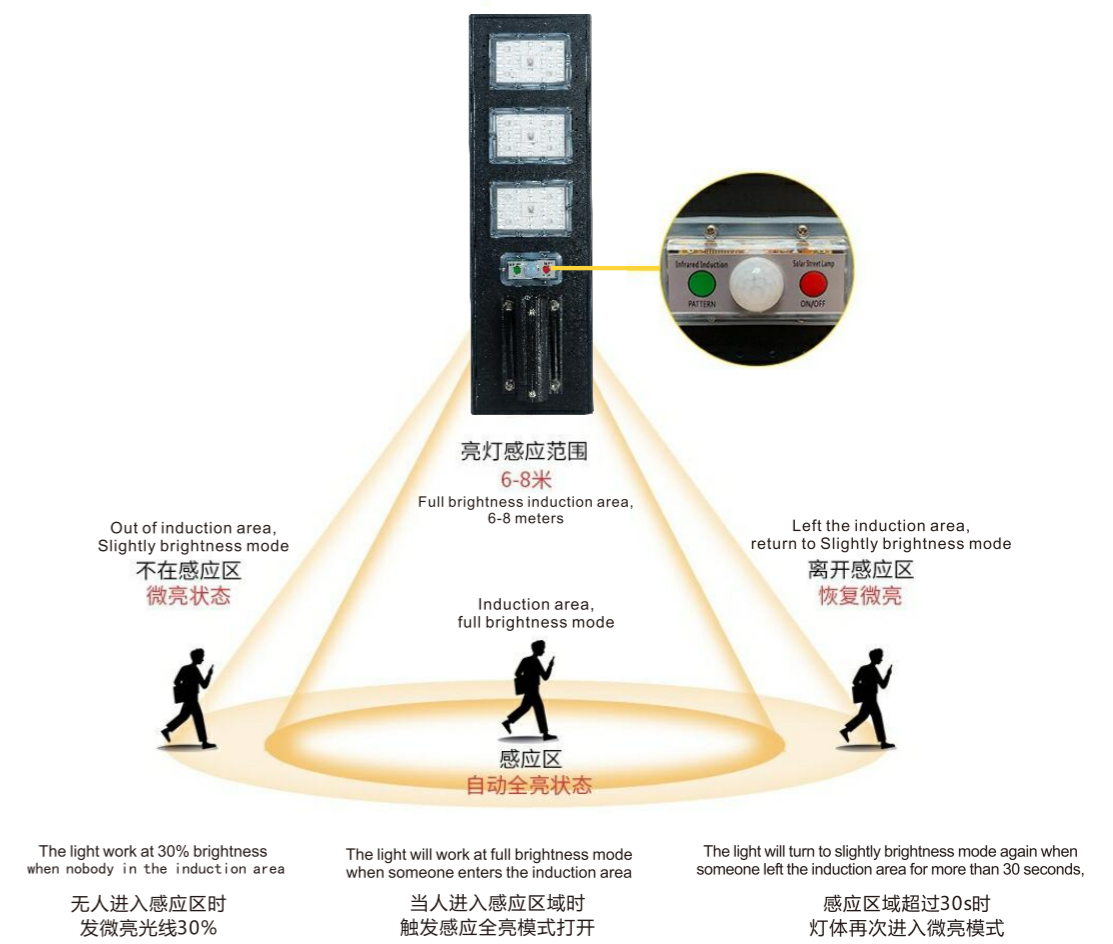

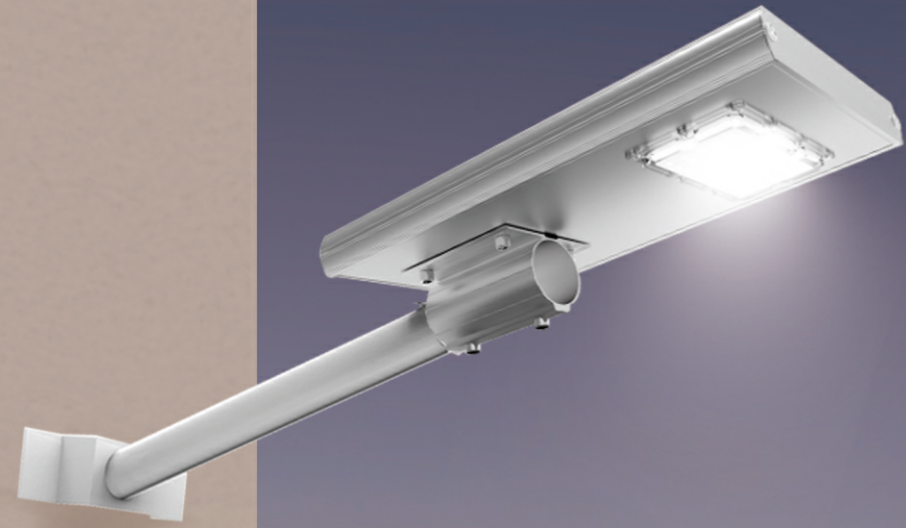

365天亮灯
户外防雨

LIGHTING 365 DAYS
OUTDOOR WATERPROOF
LIGHTING UP LIFE

Aluminium Solar street light with infrared induction sensor series

40W

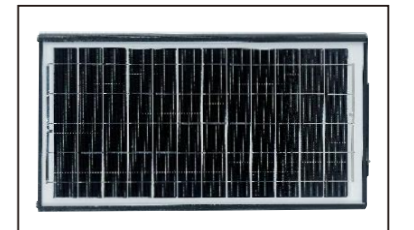
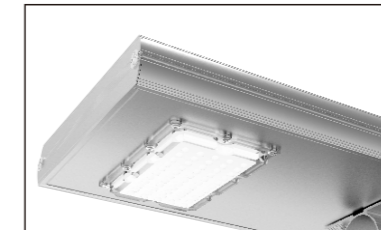
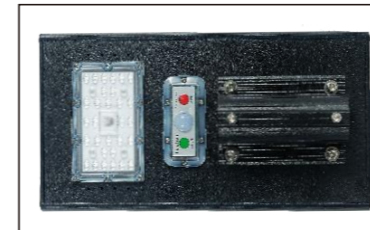

Technical Data 技术参数

Model 型号	BKD-503-1-G	Battery Capacity 电池容量	3.2V/12Ah
Material 材质	Aluminum Alloy 铝合金	Wattage 功率	40W
Solar Panel 太阳能板	High efficiency monocrystalline silicon 6V/12W 高效单晶硅6V/12W	Discharge Time 放电时间	3-5 Rainy Days 3-5个阴雨天
Working Mode 灯方式亮	Segmented time control 分段时控	Charge Time 充电时间	9-12hrs
LED Brand 芯片	3030-1/W	IP Rating	Ip65
Life Time 寿命	>50000hrs	Working Temperature(°C) 工作温度	-20°C~+60°C
Product Size(mm) 产品尺寸	372*192*88mm	Install Height(m) 安装高度	3-4M
Packing Size 包装尺寸	49.5*24*8.5cm	20GP	2634
Net Weight 净重	1.56kg	40GP	5268
Gross Weight 毛重	1.85kg	40HQ	6397

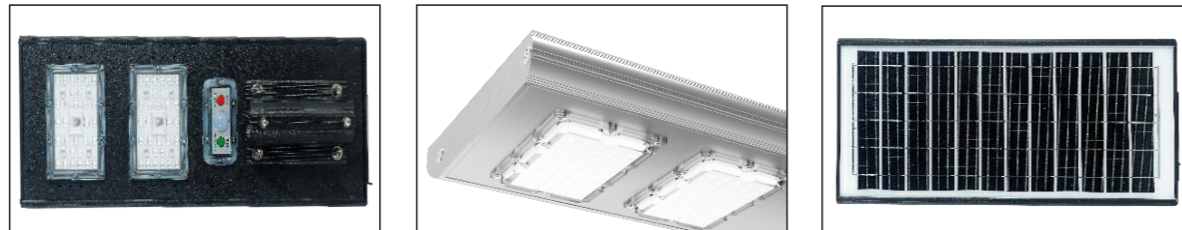

Technical Data 技术参数

Model 型号	BKD-503-2-G	Battery Capacity 电池容量	3.2V/18Ah
Material 材质	Aluminum Alloy 铝合金	Wattage 功率	80W
Solar Panel 太阳能板	High efficiency monocrystalline silicon 6V/18W 高效单晶硅6V/18W	Discharge Time 放电时间	3-5Rainy Days 3-5个阴雨天
Working Mode 灯方式亮	Segmented time control 分段时控	Charge Time 充电时间	9-12hrs
LED Brand 芯片	3030-1/W	IP Rating	Ip65
Life Time 寿命	>50000hrs	Working Temperature(°C) 工作温度	-20°C~+60°C
Product Size(mm) 产品尺寸	486*192*88mm	Install Height(m) 安装高度	4-5M
Packing Size 包装尺寸	61.5*24*8.5mm	20GP	2120
Net Weight 净重	1.85kg	40GP	4240
Gross Weight 毛重	2.27kg	40HQ	5149

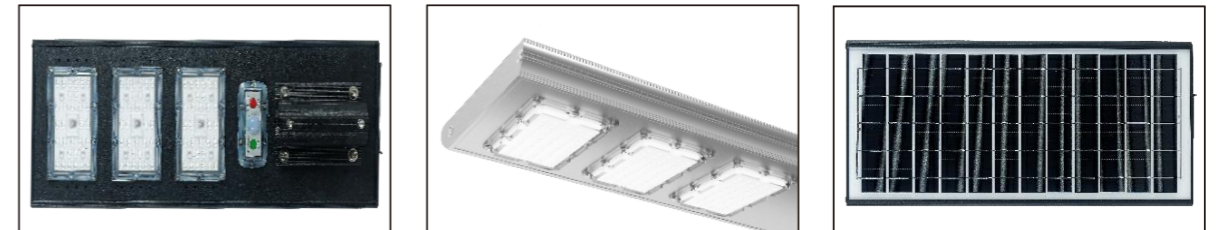

Technical Data 技术参数

Model 型号	BKD-503-3-G	Battery Capacity 电池容量	3.2V/24Ah
Material 材质	Aluminum Alloy 铝合金	Wattage 功率	120W
Solar Panel 太阳能板	High efficiency monocrystalline silicon 6V/24W 高效单晶硅6V/24W	Discharge Time 放电时间	3-5Rainy Days 3-5个阴雨天
Working Mode 灯方式亮	Segmented time control 分段时控	Charge Time 充电时间	9-12hrs
LED Brand 芯片	3030-1/W	IP Rating	Ip65
Life Time 寿命	>50000hrs	Working Temperature(°C) 工作温度	-20°C~+60°C
Product Size(mm) 产品尺寸	570*192*88mm	Install Height(m) 安装高度	5-6M
Packing Size 包装尺寸	69.5*24*8.5cm	20GP	1876
Net Weight 净重	2.35kg	40GP	3752
Gross Weight 毛重	2.79kg	40HQ	4556



INTEGRATED SOLAR STREET LIGHT FOR COUNTRY ROADS
乡村道路一体化太阳能路灯

160W

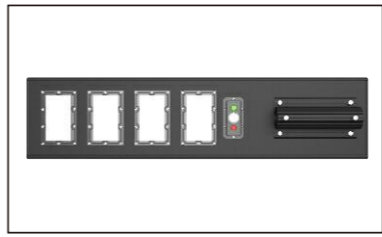

Technical Data 技术参数

Model 型号	BKD-503-4-G	Battery Capacity 电池容量	3.2V/30Ah
Material 材质	Aluminum Alloy 铝合金	Wattage 功率	160W
Solar Panel 太阳能板	High efficiency monocrystalline silicon 6V/24W 高效单晶硅6V/30W	Discharge Time 放电时间	3-5 Rainy Days 3-5个阴雨天
Working Mode 灯方式亮	Segmented time control 分段时控	Charge Time 充电时间	9-12hrs
LED Brand 芯片	3030-1/W	IP Rating	Ip65
Life Time 寿命	>50000hrs	Working Temperature(°C) 工作温度	-20°C~+60°C
Product Size(mm) 产品尺寸	775*192*88mm	Install Height(m) 安装高度	5-6M
Packing Size 包装尺寸	90*24*8.5cm	20GP	1449
Net Weight 净重	3.35kg	40GP	2898
Gross Weight 毛重	3.9kg	40HQ	3519



LIGHTING 365 DAYS

365天亮灯 户外防雨

一体化太阳能路灯
让灯光点缀生活
OUTDOOR WATERPROOF
LIGHTING UP LIFE

Aluminium Solar street light with infrared induction sensor series

50W

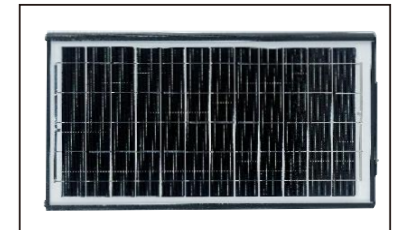
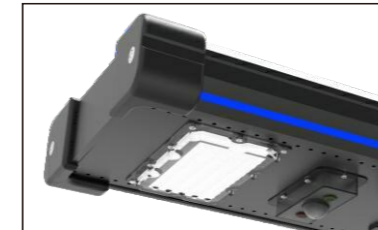
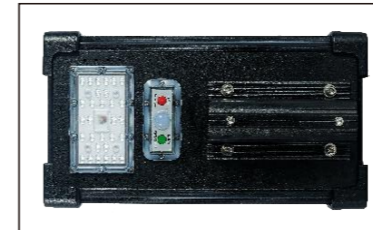

Technical Data 技术参数

Model 型号	BKD-603-1-G	Battery Capacity 电池容量	3.2V/15Ah
Material 材质	Aluminum Alloy 铝合金	Wattage 功率	50W
Solar Panel 太阳能板	High efficiency monocrystalline silicon 6V/10W 高效单晶硅6V/12W	Discharge Time 放电时间	3-5 Rainy Days 3-5个阴雨天
Working Mode 灯方式亮	Segmented time control 分段时控	Charge Time 充电时间	9-12hrs
LED Brand 芯片	3030-1/W	IP Rating	Ip65
Life Time 寿命	>50000hrs	Working Temperature(°C) 工作温度	-20°C~+60°C
Product Size(mm) 产品尺寸	398*200*45mm	Install Height(m) 安装高度	3-5M
Packing Size 包装尺寸	53.5*25*10cm	20GP	1989
Net Weight 净重	2.42kg	40GP	3978
Gross Weight 毛重	2.83kg	40HQ	4830



LIGHTING 365 DAYS

365天亮灯 户外防雨

一体化太阳能路灯
让灯光点缀生活
OUTDOOR WATERPROOF
LIGHTING UP LIFE

Aluminium Solar street light with infrared induction sensor series

100W

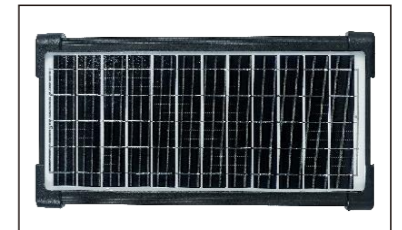
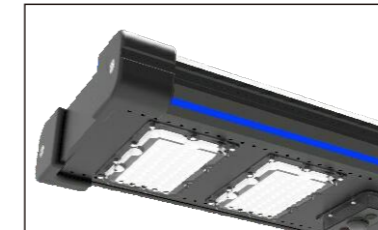

Technical Data 技术参数

Model 型号	BKD-603-2-G	Battery Capacity 电池容量	3.2V/24Ah
Material 材质	Aluminum Alloy 铝合金	Wattage 功率	100W
Solar Panel 太阳能板	High efficiency monocrystalline silicon 6V/18W 高效单晶硅6V/18W	Discharge Time 放电时间	3-5 Rainy Days 3-5个阴雨天
Working Mode 亮灯方式	Segmented time control 分段时控	Charge Time 充电时间	9-12hrs
LED Brand 芯片	3030-1/W	IP Rating	Ip65
Life Time 寿命	>50000hrs	Working Temperature(°C) 工作温度	-20°C~+60°C
Product Size(mm) 产品尺寸	572*200*45mm	Install Height(m) 安装高度	4-6M
Packing size 包装尺寸	71*25*10cm	20GP	1499
Net Weight 净重	3.22kg	40GP	2997
Gross weight 毛重	3.73kg	40HQ	3639



150W

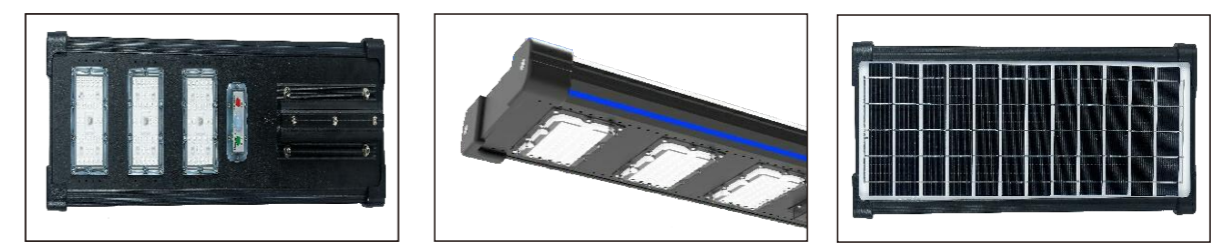

Technical Data 技术参数

Model 型号	BKD-603-3-G	Battery Capacity 电池容量	3.2V/30Ah
Material 材质	Aluminum Alloy 铝合金	Wattage 功率	150W
Solar Panel 太阳能板	High efficiency monocrystalline silicon 6V/24W 高效单晶硅6V/24W	Discharge Time 放电时间	3-5 Rainy Days 3-5个阴雨天
Working Mode 亮灯方式	Segmented time control 分段时控	Charge Time 充电时间	9-12hrs
LED Brand 芯片	3030-1/W	IP Rating	Ip65
Life Time 寿命	>50000hrs	Working Temperature(°C) 工作温度	-20°C~+60°C
Product Size(mm) 产品尺寸	774*200*45mm	Install Height(m) 安装高度	5-7M
Packing size 包装尺寸	91*25*10cm	20GP	1169
Net Weight 净重	4.23kg	40GP	2338
Gross weight 毛重	4.6kg	40HQ	2840



200W

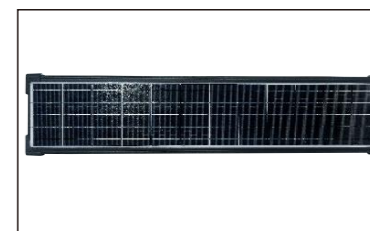
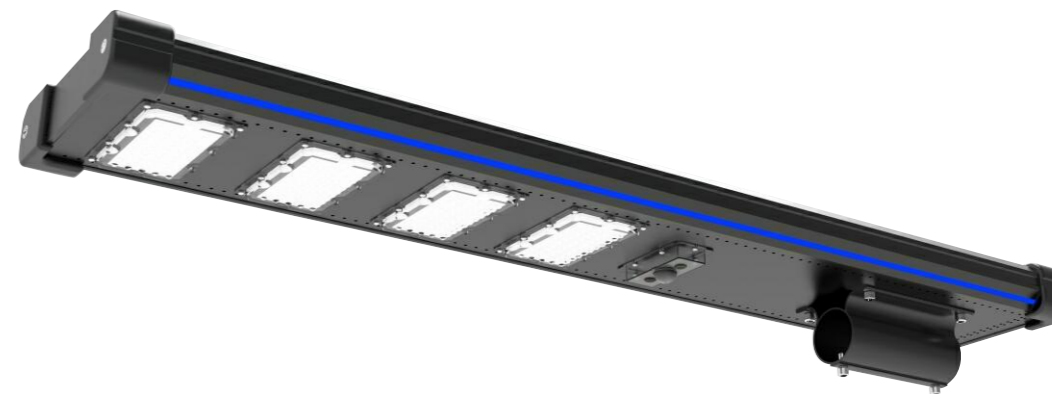

Technical Data 技术参数

Model 型号	BKD-603-4-G	Battery Capacity 电池容量	3.2V/36Ah
Material 材质	Aluminum Alloy 铝合金	Wattage 功率	200W
Solar Panel 太阳能板	High efficiency monocrystalline silicon 6V/30W 高效单晶硅6V/30W	Discharge Time 放电时间	3-5 Rainy Days 3-5个阴雨天
Working Mode 灯方式亮	Segmented time control 分段时控	Charge Time 充电时间	9-12hrs
LED Brand 芯片	3030-1/W	IP Rating	Ip65
Life Time 寿命	>50000hrs	Working Temperature(°C) 工作温度	-20°C~+60°C
Product Size(mm) 产品尺寸	993*200*45mm	Install Height(m) 安装高度	6-8M
Packing Size 包装尺寸	114*25*10cm	20GP	933
Net Weight 净重	5.09kg	40GP	1867
Gross Weight 毛重	5.55kg	40HQ	2267



90°

Adjust the mouted angle
随心调节角度方向

Adjust the mouted angle according the actual demand to satisfy solar panel ligting need

Intergrated Solar Garden L amp

— 150W

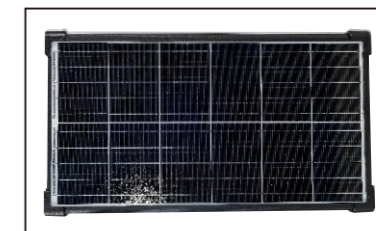

Technical Data 技术参数

Model 型号	BKD-602H-150G	Battery Capacity 电池容量	3.2V/20Ah
Material 材质	Aluminum Alloy 铝合金	Wattage 功率	150W
Solar Panel 太阳能板	High efficiency monocrystalline silicon 6V/24W 高效单晶硅 6V/30W	Discharge Time 放电时间	5-7Rainy Days 5-7个阴雨天
Working Mode 灯方式亮	Segmented time contro l 分段时控	Charge Time 充电时间	9-12hrs
LED Brand 芯片	3030-1/W	IP Rating	Ip65
Life Time 寿命	>60000hrs	Working Temperature(°C) 工作温度	-40°C~+70°C
Product Size(mm) 产品尺寸	530*362*45mm	Install Height(m) 安装高度	2.5-3M
Packing Size 包装尺寸	66.5*41.5*10cm	20GP	964
Net Weight 净重	5.83kg	40GP	1928
Gross Weight 毛重	6.6kg	40HQ	2341



Intergrated Solar Garden L amp
— 200W

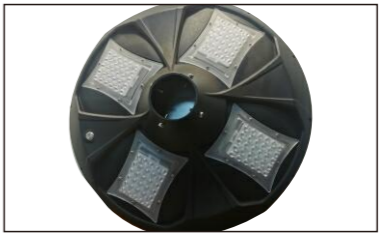
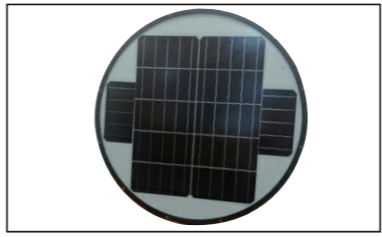

Technical Data 技术参数

Model 型号	BKD-202G	Battery Capacity 电池容量	3.2V/40Ah
Material 材质	Aluminum Alloy 铝合金	Wattage 功率	200W
Solar Panel 太阳能板	High efficiency monocrystalline silicon 6V/35W 高效单晶硅 6V/35W	Discharge Time 放电时间	3-5Rainy Days 3-5个阴雨天
Working Mode 灯方式亮	Segmented time control 分段时控	Charge Time 充电时间	9-12hrs
LED Brand 芯片	3030-1/W	IP Rating	Ip65
Life Time 寿命	>60000hrs	Working Temperature(°C) 工作温度	-40°C~+70°C
Product Size(mm) 产品尺寸	Ø540*220mm	Install Height(m) 安装高度	2.5-3M
Packing Size 包装尺寸	58*58*23cm	20GP	344
Net Weight 净重	6kg	40GP	688
Gross Weight 毛重	6.7kg	40HQ	835



Country Road Solar Street Light Series

— 200W

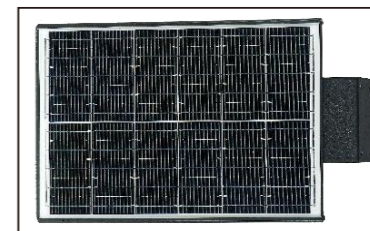
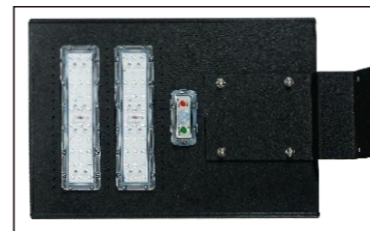

Technical Data 技术参数

Model 型号	BKD-502-2	Battery Capacity 电池容量	3.2V/20Ah
Material 材质	Aluminum Alloy 铝合金	Wattage 功率	200W
Solar Panel 太阳能板	High efficiency monocrystalline silicon 6V/24W 高效单晶硅6V/24W	Discharge Time 放电时间	3-5 Rainy Days 3-5个阴雨天
Working Mode 灯方式亮	Segmented time control 分段时控	Charge Time 充电时间	6-9hrs
LED Brand 芯片	3030-1/W	IP Rating	Ip65
Life Time 寿命	>6000hrs	Working Temperature(°C) 工作温度	-40°C~+70°C
Product Size(mm) 产品尺寸	528*350*32mm	Install Height(m) 安装高度	4-5M
Packing Size 包装尺寸	58*40.5*8.5cm 32*19*14cm	20GP	1278
Net Weight 净重	5.6kg	40GP	2556
Gross Weight 毛重	6.5kg	40HQ	3103

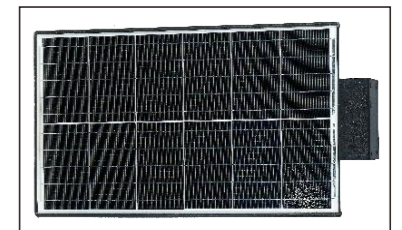
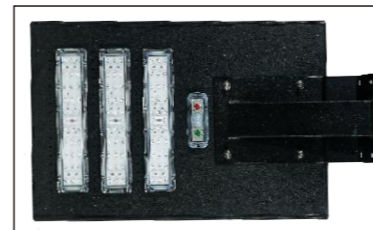

Technical Data 技术参数

Model 型号	BKD-502-3	Battery Capacity 电池容量	3.2V/30Ah
Material 材质	Aluminum Alloy 铝合金	Wattage 功率	300W
Solar Panel 太阳能板	High efficiency monocrystalline silicon 6V/40W 高效单晶硅6V/40W	Discharge Time 放电时间	3-5 Rainy Days 3-5个阴雨天
Working Mode 灯方式亮	Segmented time control 分段时控	Charge Time 充电时间	6-9hrs
LED Brand 芯片	3030-1/W	IP Rating	Ip65
Life Time 寿命	>6000hrs	Working Temperature(°C) 工作温度	-40°C~+70°C
Product Size(mm) 产品尺寸	685*350*32mm	Install Height(m) 安装高度	5-6M
Packing Size 包装尺寸	73.5*40.5*8.5cm 37*16*10cm	20GP	941
Net Weight 净重	6.3kg	40GP	1882
Gross Weight 毛重	7.2kg	40HQ	2286



Country Road Solar Street Light Series

— 400W

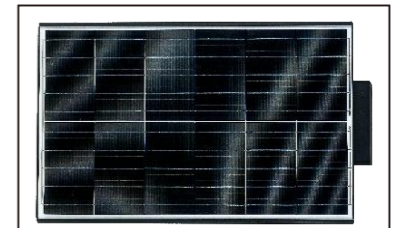
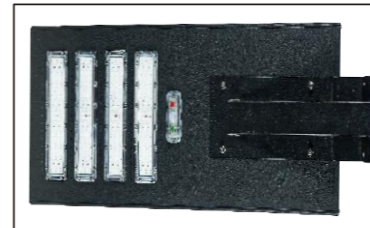

Technical Data 技术参数

Model 型号	BKD-502-4	Battery Capacity 电池容量	3.2V/42Ah
Material 材质	Aluminum Alloy 铝合金	Wattage 功率	400W
Solar Panel 太阳能板	High efficiency monocrystalline silicon 6V/60W 高效单晶硅6V/60W	Discharge Time 放电时间	3-5 Rainy Days 3-5个阴雨天
Working Mode 灯方式亮	Segmented time control 分段时控	Charge Time 充电时间	6-9hrs
LED Brand 芯片	Bridgelux-USA 普瑞·美国	IP Rating	Ip65
Life Time 寿命	>60000hrs	Working Temperature(°C) 工作温度	-40°C~+70°C
Product Size(mm) 产品尺寸	996*350*32mm	Install Height(m) 安装高度	5-8M
Packing Size 包装尺寸	104.5*40.5*8.5cm 50*16*10cm	20GP	665
Net Weight 净重	8.5kg	40GP	1331
Gross Weight 毛重	9.5kg	40HQ	1616



Mainroad Solar Street lamp with Aluminium body series

— 100W

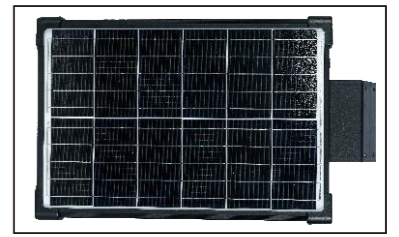
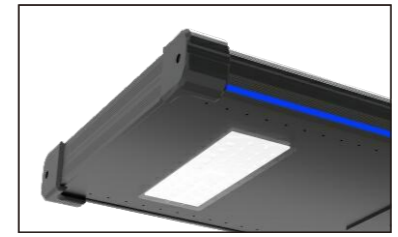
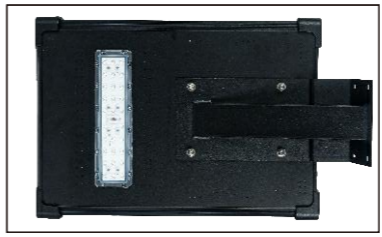
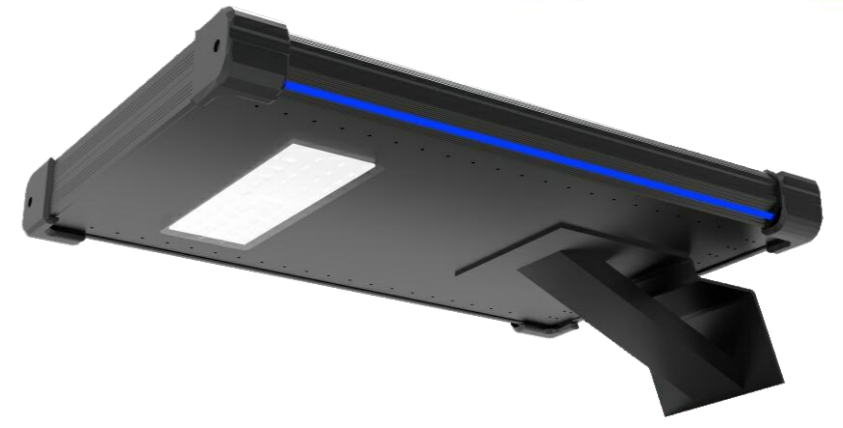

Technical Data 技术参数

Model 型号	BKD-602-1	Battery Capacity 电池容量	3.2V/20Ah
Material 材质	Aluminum Alloy 铝合金	Wattage 功率	100W
Solar Panel 太阳能板	High efficiency monocrystalline silicon 6V/24W 高效单晶硅 6V/24W	Discharge Time 放电时间	5-7 Rainy Days 5-7个阴雨天
Working Mode 灯方式亮	Segmented time control 分段时控	Charge Time 充电时间	6-9hrs
LED Brand 芯片	Bridgelux-USA 普瑞-美国	IP Rating	Ip65
Life Time 寿命	>50000hrs	Working Temperature(°C) 工作温度	-40°C~+70°C
Product Size(mm) 产品尺寸	530*362*45mm	Install Height(m) 安装高度	3-4M
Packing Size 包装尺寸	59.5*41.5*10cm 37*16*10cm	20GP	1738
Net Weight 净重	6.19kg	40GP	3476
Gross Weight 毛重	7.1kg	40HQ	4220



Mainroad Solar Street lamp with Aluminium body series

200W

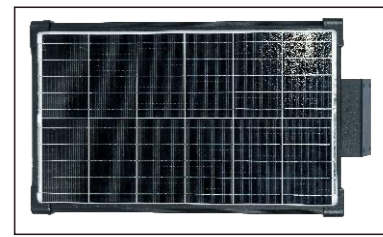
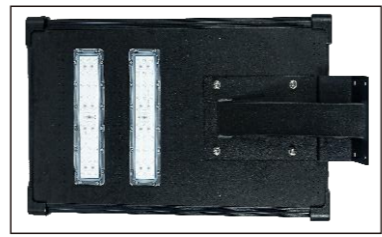

Technical Data 技术参数

Model 型号	BKD-602-2	Battery Capacity 电池容量	3.2V/42Ah
Material 材质	Aluminum Alloy 铝合金	Wattage 功率	200W
Solar Panel 太阳能板	High efficiency monocrystalline silicon 6V/40W 高效单晶硅 6V/40W	Discharge Time 放电时间	5-7Rainy Days 5-7个阴雨天
Working Mode 灯方式亮	Segmented time control 分段时控	Charge Time 充电时间	9-12hrs
LED Brand 芯片	Bridgelux-USA 普瑞-美国	IP Rating	Ip65
Life Time 寿命	>50000hrs	Working Temperature(°C) 工作温度	-40°C~+70°C
Product Size(mm) 产品尺寸	685*362*45mm	Install Height(m) 安装高度	4-5M
Packing Size 包装尺寸	75*41.5*10cm 37*16*10cm	20GP	780
Net Weight 净重	7.32kg	40GP	1561
Gross Weight 毛重	8.26kg	40HQ	1895

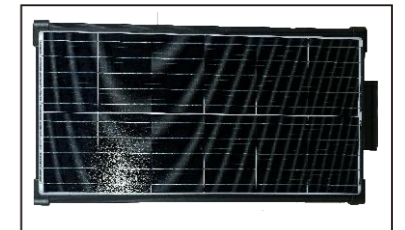
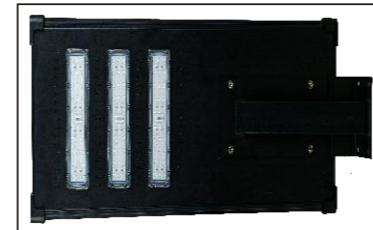

Technical Data 技术参数

Model 型号	BKD-602-3	Battery Capacity 电池容量	3.2V/84Ah
Material 材质	Aluminum Alloy 铝合金	Wattage 功率	300W
Solar Panel 太阳能板	High efficiency monocrystalline silicon 6V/60W 高效单晶硅 6V/60W	Discharge Time 放电时间	5-7Rainy Days 5-7个阴雨天
Working Mode 灯方式亮	Segmented time control 分段时控	Charge Time 充电时间	9-12hrs
LED Brand 芯片	Bridgelux-USA 普瑞-美国	IP Rating	Ip65
Life Time 寿命	>50000hrs	Working Temperature(°C) 工作温度	-40°C~+70°C
Product Size(mm) 产品尺寸	1000*362*45mm	Install Height(m) 安装高度	5-7M
Packing Size 包装尺寸	106*41.5*10cm 50*16*10cm	20GP	554
Net Weight 净重	10.38kg	40GP	1109
Gross Weight 毛重	11.33kg	40HQ	1346



Mainroad Solar Street lamp with Aluminium body series

— 400W

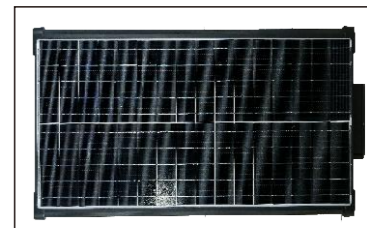
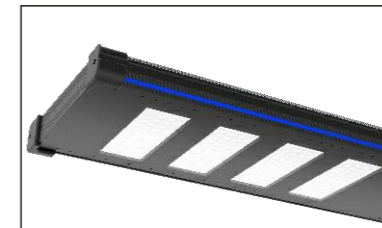
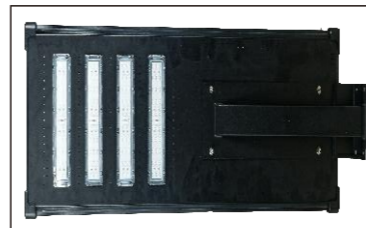
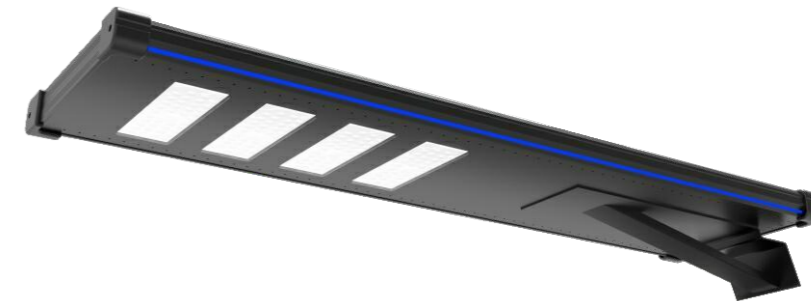

Technical Data 技术参数

Model 型号	BKD-602-4	Battery Capacity 电池容量	12.8V/40Ah
Material 材质	Aluminum Alloy 铝合金	Wattage 功率	400W
Solar Panel 太阳能板	High efficiency monocrystalline silicon 18V/80W 高效单晶硅 18V/80W	Discharge Time 放电时间	5-7Rainy Days 5-7个阴雨天
Working Mode 灯方式亮	Segmented time control 分段时控	Charge Time 充电时间	9-12hrs
LED Brand 芯片	Bridgelux-USA 普瑞-美国	IP Rating	Ip65
Life Time 寿命	>50000hrs	Working Temperature(°C) 工作温度	-40°C~+70°C
Product Size(mm) 产品尺寸	1295*362*45mm	Install Height(m) 安装高度	6-9M
Packing Size 包装尺寸	133.5*41.5*10cm 70*16*10cm	20GP	436
Net Weight 净重	14.8kg	40GP	872
Gross Weight 毛重	15.7kg	40HQ	1059



Lighting on rainy night Anti-thunder Waterproof
阴雨天也能亮灯·防雷击防闪电防雨

Movable Mounted integrated solar street lamp

— 150W

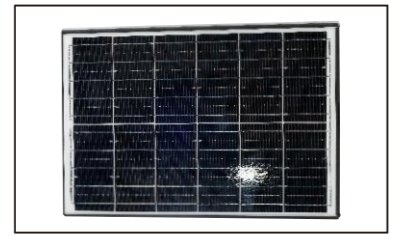

Technical Data 技术参数

Model 型号	BKD-502H-150	Battery Capacity 电池容量	3.2V/20Ah
Material 材质	Aluminum Alloy 铝合金	Wattage 功率	150W
Solar Panel 太阳能板	High efficiency monocrystalline silicon 6V/30W 高效单晶硅 6V/30W	Discharge Time 放电时间	3-5Rainy Days 3-5个阴雨天
Working Mode 灯方式亮	Segmented time control 分段时控	Charge Time 充电时间	9-12hrs
LED Brand 芯片	3030-1/W	IP Rating	Ip65
Life Time 寿命	>6000hrs	Working Temperature(°C) 工作温度	-40°C~+70°C
Product Size(mm) 产品尺寸	528*351mm	Install Height(m) 安装高度	3-5M
Packing Size 包装尺寸	66*40*8.5cm	20GP	1185
Net Weight 净重	5.5kg	40GP	2371
Gross Weight 毛重	6.5kg	40HQ	2879

Movable Mounted integrated solar street lamp

— 300W

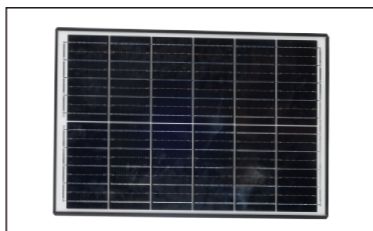
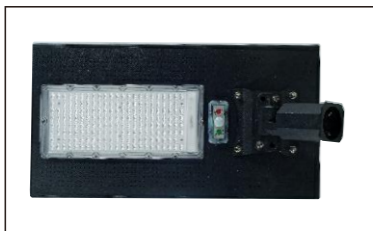

Technical Data 技术参数

Model 型号	BKD-502H-300	Battery Capacity 电池容量	3.2V/30Ah
Material 材质	Aluminum Alloy 铝合金	Wattage 功率	300W
Solar Panel 太阳能板	High efficiency monocrystalline silicon 6V/40W 高效单晶硅 6V/40W	Discharge Time 放电时间	3-5Rainy Days 3-5个阴雨天
Working Mode 灯方式亮	Segmented time control 分段时控	Charge Time 充电时间	9-12hrs
LED Brand 芯片	3030-1/W	IP Rating	Ip65
Life Time 寿命	>6000hrs	Working Temperature(°C) 工作温度	-40°C~+70°C
Product Size(mm) 产品尺寸	683*351mm	Install Height(m) 安装高度	4-6M
Packing Size 包装尺寸	81.5*40*8.5cm	20GP	960
Net Weight 净重	6.23kg	40GP	1920
Gross Weight 毛重	7.1kg	40HQ	2331

Movable Mounted integrated solar street lamp

— 450W

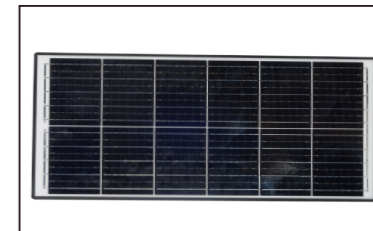
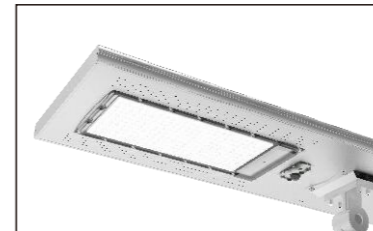

Technical Data 技术参数

Model 型号	BKD-502H-450	Battery Capacity 电池容量	3.2V/42Ah
Material 材质	Aluminum Alloy 铝合金	Wattage 功率	450W
Solar Panel 太阳能板	High efficiency monocrystalline silicon 6V/60W 高效单晶硅 6V/60W	Discharge Time 放电时间	3-5Rainy Days 3-5个阴雨天
Working Mode 灯方式亮	Segmented time control 分段时控	Charge Time 充电时间	9-12hrs
LED Brand 芯片	3030-1/W	IP Rating	Ip65
Life Time 寿命	>6000hrs	Working Temperature(°C) 工作温度	-40°C~+70°C
Product Size(mm) 产品尺寸	996*351mm	Install Height(m) 安装高度	5-7M
Packing Size 包装尺寸	113*40*8.5cm	20GP	692
Net Weight 净重	8.2kg	40GP	1385
Gross Weight 毛重	9.2kg	40HQ	1681



Adjust the mounted angle
随心调节角度方向

90°

Intergrated Solar Street Light for Parking Lot/Square

— 150W

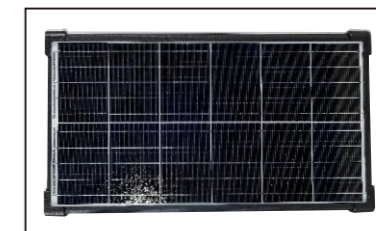

Technical Data 技术参数

Model 型号	BKD-602H-150	Battery Capacity 电池容量	3.2V/20Ah
Material 材质	Aluminum Alloy 铝合金	Wattage 功率	150W
Solar Panel 太阳能板	High efficiency monocrystalline silicon 6V/24W 高效单晶硅 6V/30 W	Discharge Time 放电时间	5-7 Rainy Days 5-7个阴雨天
Working Mode 亮灯方式	Segmented time control 分段时控	Charge Time 充电时间	9-12hrs
LED Brand 芯片	3030-1/W	IP Rating	Ip65
Life Time 寿命	>60000hrs	Working Temperature(°C) 工作温度	-40°C~+70°C
Product Size(mm) 产品尺寸	530*362*45mm	Install Height(m) 安装高度	5-6M
Packing size 包装尺寸	66.5*41.5*10cm	20GP	964
Net weight 净重	5.83kg	40GP	1928
Gross weight 毛重	6.6kg	40HQ	2341



Aluminium solar street light with infrared induction sensors series

— 300W

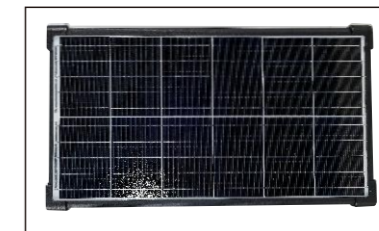

Technical Data 技术参数

Model 型号	BKD-602H-300	Battery Capacity 电池容量	3.2V/42Ah
Material 材质	Aluminum Alloy 铝合金	Wattage 功率	300W
Solar Panel 太阳能板	High efficiency monocrystalline silicon 6V/40W 高效单晶硅 6V/40W	Discharge Time 放电时间	3-5 Rainy Days 3-5个阴雨天
Working Mode 亮灯方式	Segmented time control 分段时控	Charge Time 充电时间	9-12hrs
LED Brand 芯片	3030-1/W	IP Rating	Ip65
Life Time 寿命	>6000hrs	Working Temperature(°C) 工作温度	-40°C~+70°C
Product Size(mm) 产品尺寸	685*365*45mm	Install Height(m) 安装高度	5-8M
Packing Size 包装尺寸	82*41.5*10cm	20GP	782
Net Weight 净重	7.4kg	40GP	1563
Gross Weight 毛重	8.4kg	40HQ	1898



一体化太阳能路灯，广场停车场高杆灯

Intergrated Solar Street Light for
Parking Lot/Square

Intergrated Solar Street Light for Parking Lot/Square

— 450W

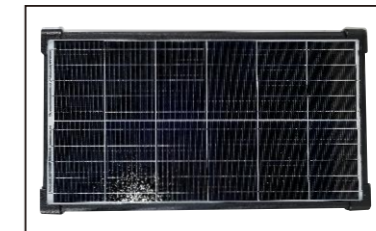

Technical Data 技术参数

Model 型号	BKD-602H-450	Battery Capacity 电池容量	3.2V/84Ah
Material 材质	Aluminum Alloy 铝合金	Wattage 功率	450W
Solar Panel 太阳能板	High efficiency monocrystalline silicon 6V/60W 高效单晶硅 6V/60W	Discharge Time 放电时间	3-5Rainy Days 3-5个阴雨天
Working Mode 亮灯方式	Segmented time control 分段时控	Charge Time 充电时间	9-12hrs
LED Brand 芯片	3030-1/W	IP Rating	Ip65
Life Time 寿命	>6000hrs	Working Temperature(°C) 工作温度	-40°C~+70°C
Product Size(mm) 产品尺寸	1000*362*45mm	Install Height(m) 安装高度	6-9M
Packing Size 包装尺寸	114*41.5*10cm	20GP	562
Net Weight 净重	10.5kg	40GP	1124
Gross Weight 毛重	11.5kg	40HQ	1365



Light sensor, Lighting Automatically
智能光控·自动开关

Movable Mounted integrated solar street lamp

150W

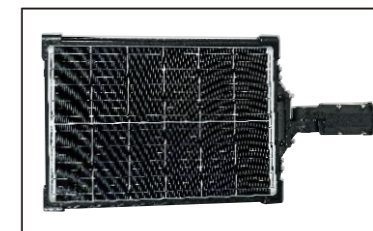
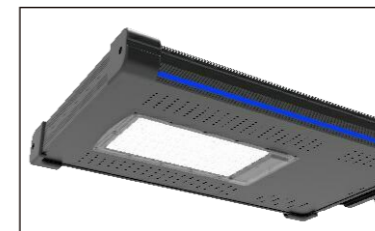
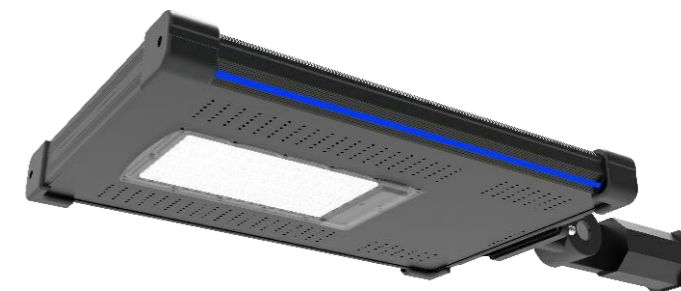

Technical Data 技术参数

Model 型号	BKD-602B-150	Battery Capacity 电池容量	3.2V/20Ah
Material 材质	Aluminum Alloy 铝合金	Wattage 功率	150W
Solar Panel 太阳能板	High efficiency monocrystalline silicon 6V/24W 高效单晶硅 6V/24W	Discharge Time 放电时间	5-7Rainy Days 5-7个阴雨天
Working Mode 亮灯方式	Segmented time control 分段时控	Charge Time 充电时间	6-9hrs
LED Brand 芯片	Bridgelux-USA 普瑞-美国	IP Rating	Ip65
Life Time 寿命	>6000hrs	Working Temperature(°C) 工作温度	-40°C~+70°C
Product Size(mm) 产品尺寸	530*362*45mm	Install Height(m) 安装高度	5-6M
Packing Size 包装尺寸	67.5*41.5*10cm	20GP	950
Net Weight 净重	5.83kg	40GP	1899
Gross Weight 毛重	6.8kg	40HQ	2306



Movable Mounted integrated solar street lamp

— 300W

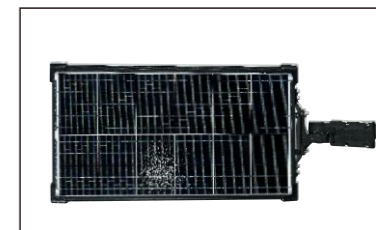
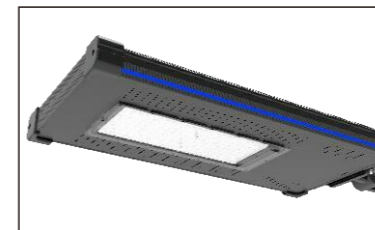
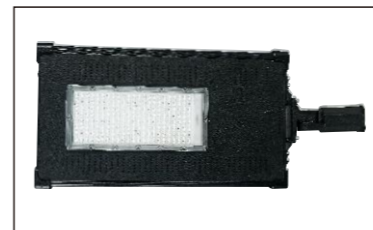

Technical Data 技术参数

Model 型号	BKD-602B-300	Battery Capacity 电池容量	3.2V/42Ah
Material 材质	Aluminum Alloy 铝合金	Wattage 功率	300W
Solar Panel 太阳能板	High efficiency monocrystalline silicon 6V/40W 高效单晶硅 6V/40W	Discharge Time 放电时间	5-7Rainy Days 5-7个阴雨天
Working Mode 亮灯方式	Segmented time control 分段时控	Charge Time 充电时间	6-9hrs
LED Brand 芯片	Bridgelux-USA 普瑞-美国	IP Rating	Ip65
Life Time 寿命	>6000hrs	Working Temperature(°C) 工作温度	-40°C~+70°C
Product Size(mm) 产品尺寸	685*362*45mm	Install Height(m) 安装高度	5-8M
Packing Size 包装尺寸	83*41.5*10cm	20GP	722
Net Weight 净重	7.24kg	40GP	1544
Gross Weight 毛重	8.2kg	40HQ	1875



microwave Induct 8-12 Meters
微波感应 8-12M

High power with infrared induction sensor series

— 400W

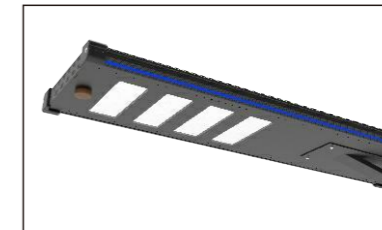
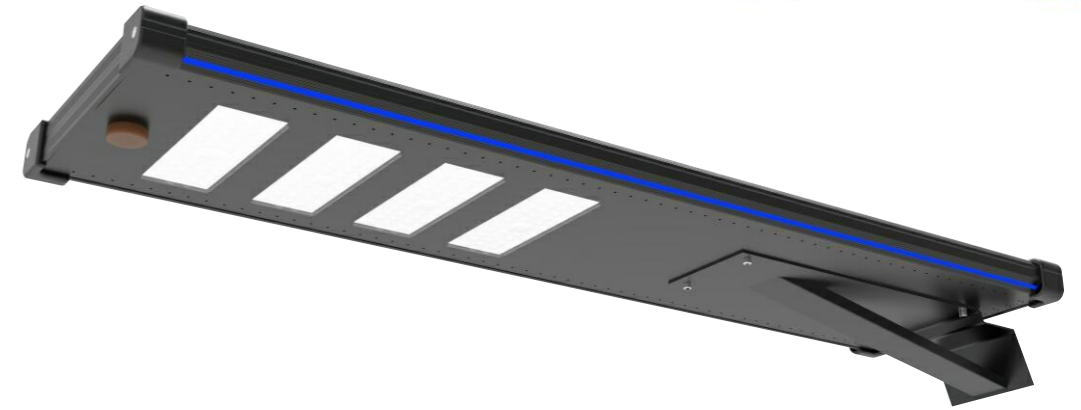

Technical Data 技术参数

Model 型号	BKD-602-4-G	Battery Capacity 电池容量	12.8V/40Ah
Material 材质	Aluminum Alloy 铝合金	Wattage 功率	400W
Solar Panel 太阳能板	High efficiency monocrystalline silicon 18V/80W 高效单晶硅 18V/80W	Discharge Time 放电时间	5-7 Rainy Days 5-7个阴雨天
Working Mode 亮灯方式	Segmented time control 分段时控	Charge Time 充电时间	6-9hrs
LED Brand 芯片	3030-1/W	IP Rating	Ip65
Life Time 寿命	>60000hrs	Working Temperature(°C) 工作温度	-40°C~+70°C
Product Size(mm) 产品尺寸	1295*362*45mm	Install Height(m) 安装高度	6-10M
Packing Size 包装尺寸	133.5*41.5*10cm 70*16*10cm	20GP	459
Net Weight 净重	14.5kg	40GP	872
Gross Weight 毛重	15.5kg	40HQ	1059



Light sensor, Light up /off automatically
智能光控，自动开关

High power with infrared induction sensor series

— 500W

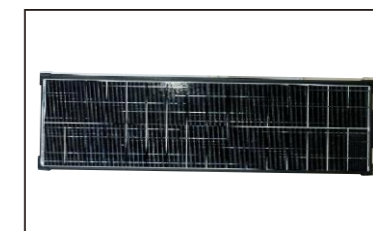

Technical Data 技术参数

Model 型号	BKD-601-5-G	Battery Capacity 电池容量	11.1V/80Ah
Material 材质	Aluminum Alloy 铝合金	Wattage 功率	500W
Solar Panel 太阳能板	High efficiency monocrystalline silicon 28V/150W 高效单晶硅 28V/150W	Discharge Time 放电时间	5-7rainy days 5-7个阴雨天
Working Mode 亮灯方式	Segmented time control 分段时控	Charge Time 充电时间	6-9hrs
LED Brand 芯片	Bridgelux-USA 普瑞-美国	IP Rating	Ip65
Life Time 寿命	>6000hrs	Working Temperature(°C) 工作温度	-40°C~+70°C
Product Size(mm) 产品尺寸	1500*530*295mm	Install Height(m) 安装高度	8-12M
Packing size 包装尺寸	155*58*30cm	20GP	99
Net weight 净重	17kg	40GP	197
Gross weight 毛重	18kg	40HQ	240



远程P2P穿透
支持主流终端设备



1 million pixels, wide-angle lens
100W 像素·广角镜头

Camera Monitoring Solar street lamp Series

— 100W

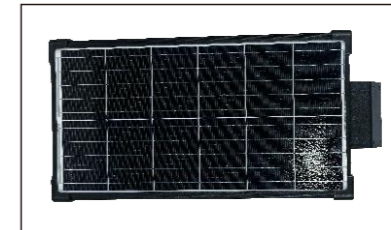
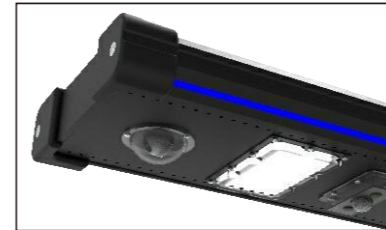

Technical Data 技术参数

Model 型号	BKD-603-2-J	Battery Capacity 电池容量	3.2V/24Ah
Material 材质	Aluminum Alloy 铝合金	Wattage 功率	100W
Solar Panel 太阳能板	High efficiency monocrystalline silicon 6V/18W 高效单晶硅6V/18W	Discharge Time 放电时间	3-5 Rainy Days 3-5个阴雨天
Working Mode 亮灯方式	Segmented time control 分段时控	Charge Time 充电时间	6-9hrs
LED Brand 芯片	3030-1/w	IP Rating	Ip65
Life Time 寿命	>50000hrs	Working Temperature(°C) 工作温度	-40°C~+70°C
Product Size(mm) 产品尺寸	572*200*45mm	Install Height(m) 安装高度	4-6M
Packing Size 包装尺寸	71*25*15cm	20GP	999
Net Weight 净重	3.82kg	40GP	1998
Gross Weight 毛重	4.32kg	40HQ	2426

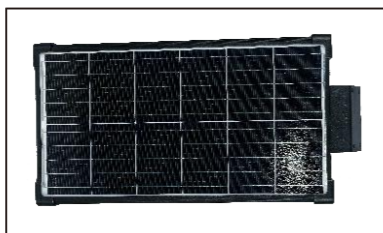
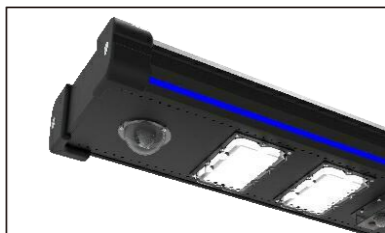

Technical Data 技术参数

Model 型号	BKD-603-3-J	Battery capacity 电池容量	3.2V/30Ah
Material 材质	Aluminum Alloy 铝合金	Wattage 功率	150W
Solar Panel 太阳能板	High efficiency monocrystalline silicon 6V/24W 高效单晶硅6V/24W	Discharge Time 放电时间	3-5 Rainy Days 3-5个阴雨天
Working Mode 亮灯方式	Segmented time control 分段时控	Charge Time 充电时间	6-9hrs
LED Brand 芯片	3030-1/w	IP Rating	Ip65
Life Time 寿命	>50000hrs	Working Temperature(°C) 工作温度	-40°C~+70°C
Product Size(mm) 产品尺寸	774*200*45mm	Install Height(m) 安装高度	5-7M
Packing Size 包装尺寸	91*25*15cm	20GP	779
Net Weight 净重	4.73kg	40GP	1559
Gross Weight 毛重	5.22kg	40HQ	1893

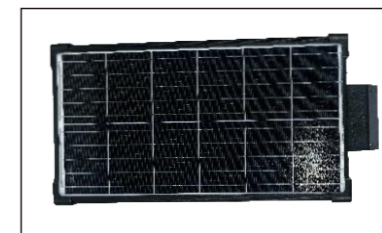
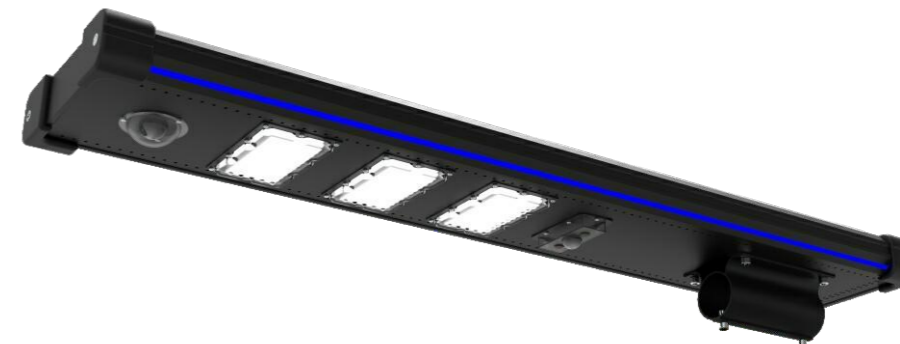

Technical Data 技术参数

Model 型号	BKD-603-4-J	Battery Capacity 电池容量	3.2V/36Ah
Material 材质	Aluminum Alloy 铝合金	Wattage 功率	200W
Solar Panel 太阳能板	High efficiency monocrystalline silicon 6V/30W 高效单晶硅6V/30W	Discharge Time 放电时间	3-5 Rainy Days 3-5个阴雨天
Working Mode 亮灯方式	Segmented time control 分段时控	Charge Time 充电时间	6-9hrs
LED Brand 芯片	3030-1/w	IP Rating	Ip65
Life Time 寿命	>50000hrs	Working Temperature(°C) 工作温度	-40°C~+70°C
Product Size(mm) 产品尺寸	993*200*45mm	Install Height(m) 安装高度	6-8M
Packing Size 包装尺寸	114*25*15cm	20GP	622
Net Weight 净重	5.59kg	40GP	1244
Gross Weight 毛重	6.05kg	40HQ	1511

2 million pixels · 360 degree full view
200W 像素 · 360全视野

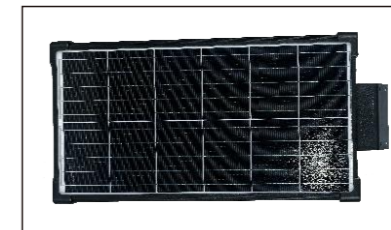

Technical Data 技术参数

Model 型号	BKD-602-2-J	Battery Capacity 电池容量	3.2V/48Ah
Material 材质	AluminumAlloy 铝合金	Wattage 功率	200W
SolarPanel 太阳能板	High efficiency monocrystalline silicon 6V/40W 高效单晶硅6V/40W	Discharge Time 放电时间	3-5 Rainy Days 3-5个阴雨天
Working Mode 亮灯方式	Segmented time control 分段时控	Charge Time 充电时间	6-9hrs
LED Brand 芯片	3030-1/w	IP Rating	Ip65
Life Time 寿命	>50000hrs	Working Temperature(°C) 工作温度	-40°C~+70°C
Product Size(mm) 产品尺寸	685*362*45mm	Install Height(m) 安装高度	5-8M
Packing Size 包装尺寸	75*41.5*18cm	20GP	475
Net Weight 净重	6.15kg	40GP	950
Gross Weight 毛重	6.85kg	40HQ	1153

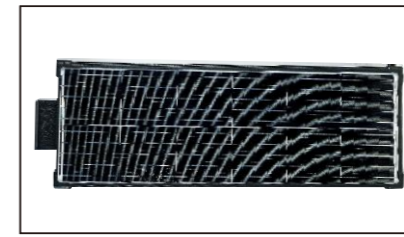

Technical Data 技术参数

Model 型号	BKD-602-3-J	Battery Capacity 电池容量	3.2V/84Ah
Material 材质	AluminumAlloy 铝合金	Wattage 功率	300W
SolarPanel 太阳能板	High efficiency monocrystalline silicon 6V/60W 高效单晶硅6V/60W	Discharge Time 放电时间	3-5 Rainy Days 3-5个阴雨天
Working Mode 亮灯方式	Segmented time control 分段时控	Charge Time 充电时间	6-9hrs
LED Brand 芯片	3030-1/w	IP Rating	Ip65
Life Time 寿命	>50000hrs	Working Temperature(°C) 工作温度	-40°C~+70°C
Product Size(mm) 产品尺寸	1000*362*45mm	Install Height(m) 安装高度	6-9M
Packing Size 包装尺寸	106*41.5*18cm	20GP	336
Net Weight 净重	10.6kg	40GP	672
Gross Weight 毛重	11.3kg	40HQ	816



Camera Monitoring Solar street lamp Series

— 400W

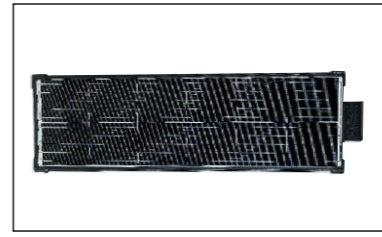
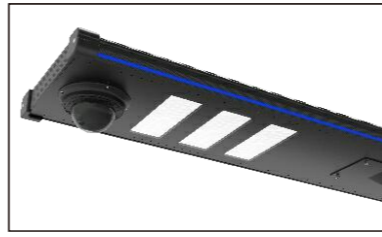

Technical Data 技术参数

Model 型号	BKD-602-4-J	Battery Capacity 电池容量	12.8V/40Ah
Material 材质	Aluminum Alloy 铝合金	Wattage 功率	400W
Solar Panel 太阳能板	High efficiency monocrystalline silicon 6V/80W 高效单晶硅18V/80W	Discharge Time 放电时间	3-5 Rainy Days 3-5个阴雨天
Working Mode 亮灯方式	Segmented time control 分段时控	Charge Time 充电时间	6-9hrs
LED Brand 芯片	3030-1/w	IP Rating	Ip65
Life Time 寿命	>50000hrs	Working Temperature(°C) 工作温度	-40°C~+70°C
Product Size(mm) 产品尺寸	1293*362*45mm	Install Height(m) 安装高度	6-10M
Packing Size 包装尺寸	138.5*41.5*18cm	20GP	257
Net Weight 净重	16.1kg	40GP	514
Gross Weight 毛重	17.1kg	40HQ	624



风光互补户外防水

Wind and photovoltaic hybrid power/ Outdoor Waterproof

Wind and photovoltaic hybrid power series

— 200W

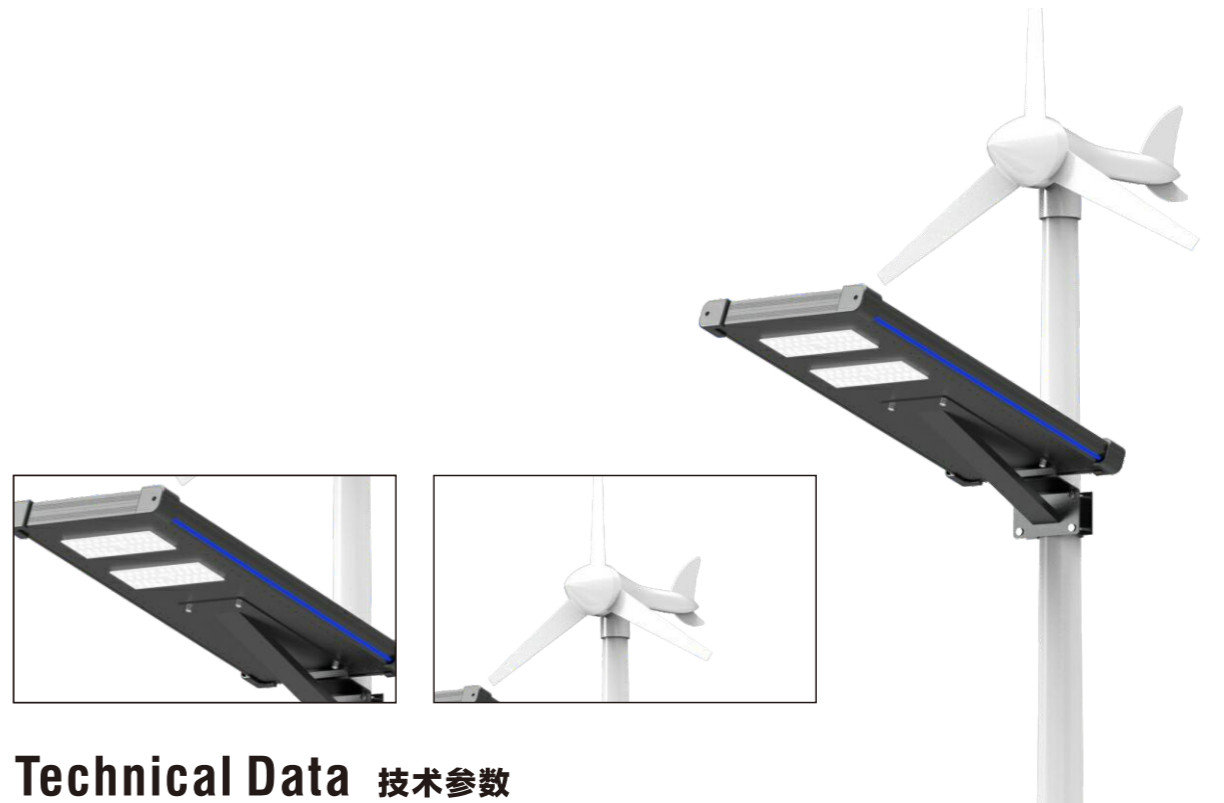

Technical Data 技术参数

Model 型号	BKD-C602-2F	Battery Capacity 电池容量	3.2V/42Ah
Material 材质	Aluminum Alloy 铝合金	Wattage 功率	200W
Solar Panel 太阳能板	High efficiency monocrystalline silicon 6V/40W 高效单晶硅 6V/40W	Discharge Time 放电时间	5-7 Rainy Days 5-7个阴雨天
Working Mode 亮灯方式	Segmented time control 分段时控	Charge Time 充电时间	6-9hrs
LED Brand 芯片	3030-1/w	IP Rating	Ip65
Life Time 寿命	>50000hrs	Working Temperature(°C) 工作温度	-40°C~+70°C
Product Size(mm) 产品尺寸	685*362*45mm	Install Height(m) 安装高度	6-7M
Packing Size 包装尺寸	75*41.5*10cm/50*33*19.5cm/37*16*10cm	20GP	384
Net Weight 净重	14.32kg	40GP	769
Gross Weight 毛重	16.5kg	40HQ	933



风光互补户外防水

Wind and photovoltaic hybrid power/ Outdoor Waterproof

Wind and photovoltaic hybrid power series

— 300W

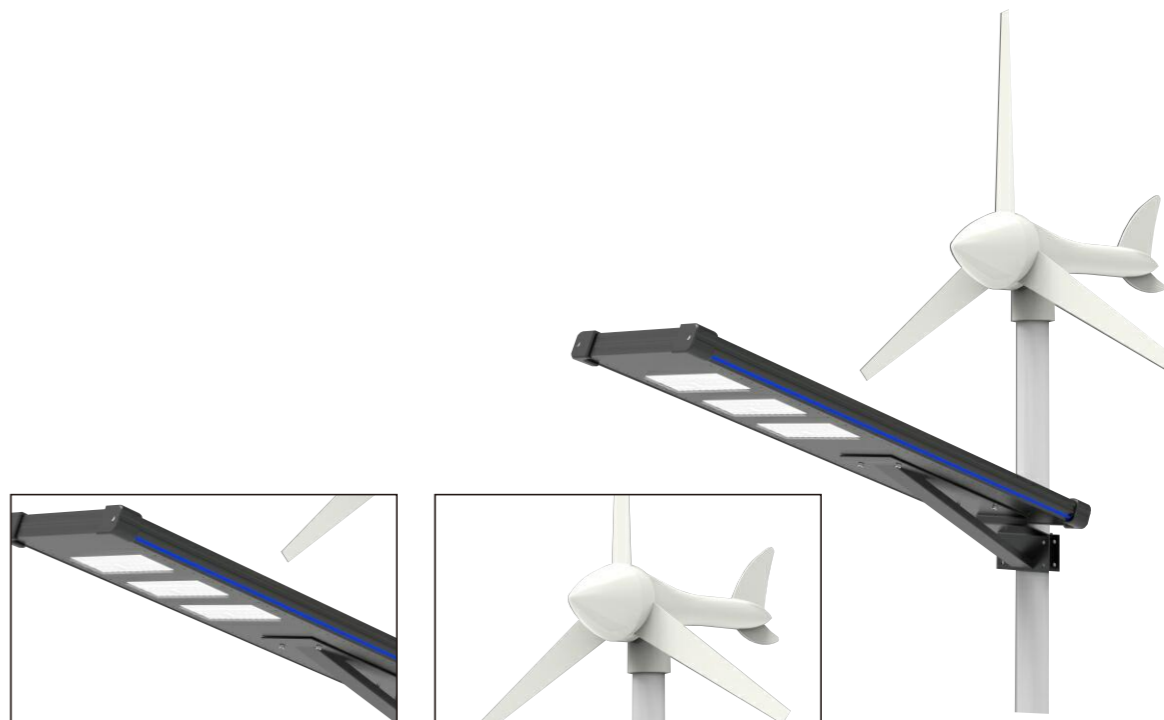

Technical Data 技术参数

Model 型号	BKD-C602-3F	Battery Capacity 电池容量	3.2V/84Ah
Material 材质	Aluminum Alloy 铝合金	Wattage 功率	300W
Solar Panel 太阳能板	High efficiency monocrystalline silicon 6V/60W 高效单晶硅 6V/60W	Discharge Time 放电时间	3-5 Rainy Days 3-5个阴雨天
Working Mode 亮灯方式	Segmented time control 分段时控	Charge Time 充电时间	6-9hrs
LED Brand 芯片	3030-1/w	IP Rating	Ip65
Life Time 寿命	>50000hrs	Working Temperature(°C) 工作温度	-40°C~+70°C
Product Size(mm) 产品尺寸	1000*362*45mm	Install Height(m) 安装高度	6-9M
Packing Size 包装尺寸	106*41.5*10cm/50*33*19.5cm/50*16*10cm	20GP	316
Net Weight 净重	17.38kg	40GP	632
Gross Weight 毛重	19.5kg	40HQ	768



Plastic Solar street light with infrared induction sensor

— 50W



Technical Data 技术参数

Model 型号	BKD-303-1-G	Battery Capacity 电池容量	3.2V/6Ah
Material 材质	Plastic 塑料	Wattage 功率	50W
Solar Panel 太阳能板	High-efficiency solar panel 高效光伏板	Discharge Time 放电时间	>10hrs
Working Mode 亮灯方式	Segmented time control 分段时控	Charge Time 充电时间	6-9hrs
LED Brand 芯片	3030-1/W	IP Rating	Ip65
Life Time 寿命	>50000hrs	Working Temperature(°C) 工作温度	-40°C~+70°C
Product Size(mm) 产品尺寸	390*195*50mm	Install Height(m) 安装高度	3M
Packing Size 包装尺寸	41*32.5*42cm	20GP	4753
Net Weight 净重	1.26kg	40GP	9506
Gross Weight 毛重	1.32kg	40HQ	11543



LIGHTING 365 DAYS

365天亮灯 户外防雨

太阳能户外灯

强劲亮度 超长续航

SOLAR OUTDOOR LIGHT

MORE BRIGHT LONG LIGHTING TIME

Plastic Solar street light with infrared induction sensor

— 100W



Technical Data 技术参数

Model 型号	BKD-303-2-G	Battery capacity 电池容量	3.2V/12Ah
Material 材质	Plastic 塑料	Wattage 功率	100W
Solar Panel 太阳能板	High-efficiency solar panel 高效光伏板	Discharge Time 放电时间	>10hrs
Working Mode 亮灯方式	Segmented time control 分段时控	Charge Time 充电时间	6-9hrs
LED Brand 芯片	3030-1/W	IP Rating	Ip65
Life Time 寿命	>50000hrs	Working Temperature(°C) 工作温度	-40°C~+70°C
Product Size(mm) 产品尺寸	485*218*50mm	Install Height(m) 安装高度	3-4M
Packing Size 包装尺寸	50.5*31.5*47cm	20GP	3558
Net Weight 净重	1.89kg	40GP	7116
Gross Weight 毛重	1.95kg	40HQ	8640

Plastic Solar street light with infrared induction sensor
150W



Technical Data 技术参数

Model 型号	BKD-303-3-G	Battery capacity 电池容量	3.2V/18Ah
Material 材质	Plastic 塑料	Wattage 功率	150W
Solar Panel 太阳能板	High-efficiency solar panel 高效光伏板	Discharge Time 放电时间	>10hrs
Working Mode 亮灯方式	Segmented time control 分段时控	Charge Time 充电时间	6-9hrs
LED Brand 芯片	3030-1/W	IP Rating	Ip65
Life Time 寿命	>50000hrs	Working Temperature(°C) 工作温度	-40°C~+70°C
Product Size(mm) 产品尺寸	620*240*50mm	Install Height(m) 安装高度	4-5M
Packing Size 包装尺寸	64*33*50.5cm	20GP	2494
Net Weight 净重	2.3kg	40GP	4988
Gross Weight 毛重	2.4kg	40HQ	6057

Plastic Solar street light with infrared induction sensor
太阳能 · — 200W



Technical Data 技术参数

Model 型号	BKD-303-4-G	Battery capacity 电池容量	3.2V/24Ah
Material 材质	Plastic 塑料	Wattage 功率	200W
Solar Panel 太阳能板	High-efficiency solar panel 高效光伏板	Discharge Time 放电时间	>10hrs
Working Mode 亮灯方式	Segmented time control 分段时控	Charge Time 充电时间	6-9hrs
LED Brand 芯片	3030-1/W	IP Rating	Ip65
Life Time 寿命	>50000hrs	Working Temperature(°C) 工作温度	-40°C~+70°C
Product Size(mm) 产品尺寸	720*240*50mm	Install Height(m) 安装高度	5-6M
Packing Size 包装尺寸	74.5*33*27cm	20GP	4007
Net Weight 净重	2.88kg	40GP	8015
Gross Weight 毛重	2.98kg	40HQ	9732



Villa Solar Street Lamp
灯-100W

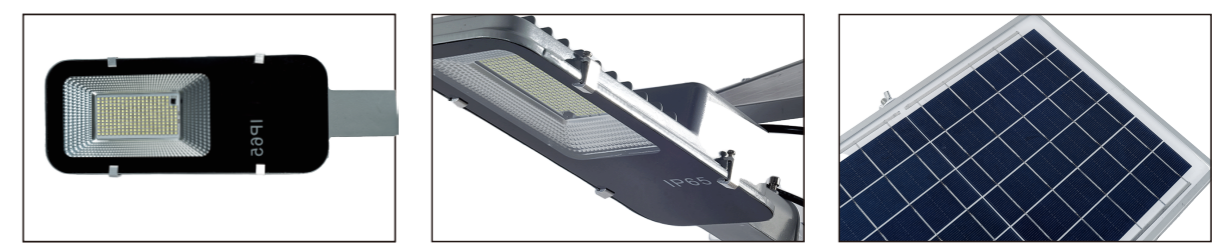

LIGHTING 365 DAYS
365天亮灯
户外防雨
太阳能户外灯,
强劲亮度 超长续航
SOLAR OUTDOOR LIGHT MORE
BRIGHT, LONG LIGHTING TIME

Technical Data 技术参数

Model 型号	BKD-803-100	Battery capacity 电池容量	3.2V/6Ah
Material 材质	Die-cast aluminum 压铸铝	Wattage 功率	100W
Solar Panel 太阳能板	High-efficiency solar panel 高效光伏板6V-15W	Discharge Time 放电时间	>10hrs
Working Mode 亮灯方式	Segmented time control 分段时控	Charge Time 充电时间	6-9hrs
LED Brand 芯片	LED 灯珠	IP Rating	Ip65
Life Time 寿命	>50000hrs	Working Temperature(°C) 工作温度	-40°C~+70°C
Product Size(mm) 产品尺寸	400*120*40mm	Install Height(m) 安装高度	3M
Packing Size 包装尺寸	43*26*12.5cm	20GP	1903
Net Weight 净重	1.88kg	40GP	3807
Gross Weight 毛重	2.36kg	40HQ	4623



LIGHTING 365 DAYS
365天亮灯
户外防雨
 太阳能户外灯，
 强劲亮度 超长续航
 SOLAR OUTDOOR LIGHT MORE
 BRIGHT, LONG LIGHTING TIME

Villa Solar Street Lamp
-200W



Technical Data 技术参数

Model 型号	BKD-803-200	Battery capacity 电池容量	3.2V/24Ah
Material 材质	Die-cast aluminum 压铸铝	Wattage 功率	200W
Solar Panel 太阳能板	High-efficiency solar panel 高效光伏板6V-30W	Discharge Time 放电时间	15hrs
Working Mode 亮灯方式	Segmented time control 分段时控	Charge Time 充电时间	6-9hrs
LED Brand 芯片	LED 灯珠	IP Rating	Ip65
Life Time 寿命	>50000hrs	Working Temperature(°C) 工作温度	-40°C~+70°C
Product Size(mm) 产品尺寸	495*210*60mm	Install Height(m) 安装高度	3-4M
Packing Size 包装尺寸	60*38*13.5cm	20GP	864
Net Weight 净重	4.14kg	40GP	1728
Gross Weight 毛重	4.64kg	40HQ	2099



separated solar street light
Saving energy Saving money, automatically inducting
分体太阳能路灯
省时省钱·自动感应

Villa Solar Street Lamp
-300W

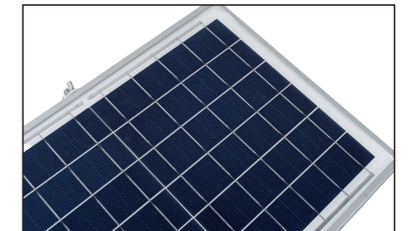
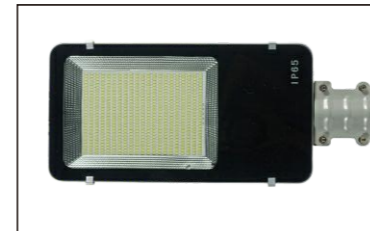

Technical Data 技术参数

Model 型号	BKD-803-300	Battery capacity 电池容量	3.2V/30Ah
Material 材质	Die-cast aluminum 压铸铝	Wattage 功率	300W
Solar Panel 太阳能板	High-efficiency solar panel 高效光伏板6V-35W	Discharge Time 放电时间	30hrs
Working Mode 亮灯方式	Segmented time control 分段时控	Charge Time 充电时间	6-9hrs
LED Brand 芯片	LED 灯珠	IP Rating	Ip65
Life Time 寿命	>50000hrs	Working Temperature(°C) 工作温度	-40°C~+70°C
Product Size(mm) 产品尺寸	495*210*60mm	Install Height(m) 安装高度	4-5M
Packing Size 包装尺寸	65*38*13.5mm	20GP	789
Net Weight 净重	4.4kg	40GP	1595
Gross Weight 毛重	4.9kg	40HQ	1937



Country Road Solar Street Lamp Series

—400W



Technical Data 技术参数

Model 型号	BKD-803-400	Battery capacity 电池容量	3.2V/42Ah
Material 材质	Die-cast aluminum 压铸铝	Wattage 功率	400W
Solar Panel 太阳能板	High-efficiency solar panel 高效光伏板6V-60W	Discharge Time 放电时间	5-7 Rainy Days 5-7个阴雨天
Working Mode 亮灯方式	Segmented time control 分段时控	Charge Time 充电时间	6-9hrs
LED Brand 芯片	LED 灯珠	IP Rating	Ip65
Life Time 寿命	>50000hrs	Working Temperature(°C) 工作温度	-40°C~+70°C
Product Size(mm) 产品尺寸	495*210*100mm	Install Height(m) 安装高度	6M
Packing Size 包装尺寸	54*52*46cm 69*16.5*57cm	20GP	684
Net Weight 净重	6.76kg	40GP	1369
Gross Weight 毛重	7kg	40HQ	1662



Country Road Solar Street Lamp Series

乡村道路太阳能路灯系列 — 500W



Technical Data 技术参数

Model 型号	BKD-803-500	Battery capacity 电池容量	3.2V/54Ah
Material 材质	Die-cast aluminum 压铸铝	Wattage 功率	500W
Solar Panel 太阳能板	High-efficiency solar panel 高效光伏板6V-80W	Discharge Time 放电时间	5-7 Rainy Days 5-7个阴雨天
Working Mode 亮灯方式	Segmented time control 分段时控	Charge Time 充电时间	6-9hrs
LED Brand 芯片	LED 灯珠	IP Rating	Ip65
Life Time 寿命	>50000hrs	Working Temperature(°C) 工作温度	-40°C~+70°C
Product Size(mm) 产品尺寸	495*210*100mm	Install Height(m) 安装高度	6-7M
Packing Size 包装尺寸	54*52*46cm 68*16.5*65.5cm	20GP	629
Net Weight 净重	7.07kg	40GP	1257
Gross Weight 毛重	7.27kg	40HQ	1527



配置升级 遥控加持

Configuration upgrade remote control

Solar flood light

—20W

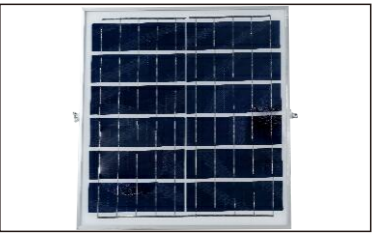

Technical Data 技术参数

Model 型号	BKD-903-20	Battery capacity 电池容量	3.2V/2Ah
Material 材质	Plastic 塑料	Wattage 功率	20W
Solar Panel 太阳能板	High Efficiency solar panel 高效光伏板6V/6W	Discharge Time 放电时间	>10hrs
Working Mode 亮灯方式	Segmented time control 分段时控	Charge Time 充电时间	6-9hrs
LED Brand 芯片	LED 灯珠	IP Rating	Ip65
Life Time 寿命	>50000hrs	Working Temperature(°C) 工作温度	-40°C~+70°C
Product Size(mm) 产品尺寸	130*120*45mm	Install Height(m) 安装高度	3M
Packing Size 包装尺寸	79*19.5*36.5cm	20GP	9461
Net Weight 净重	1.16kg	40GP	18923
Gross Weight 毛重	1.2kg	40HQ	22978



配置升级 遥控加持

Configuration upgrade remote control

Solar flood light

—50W

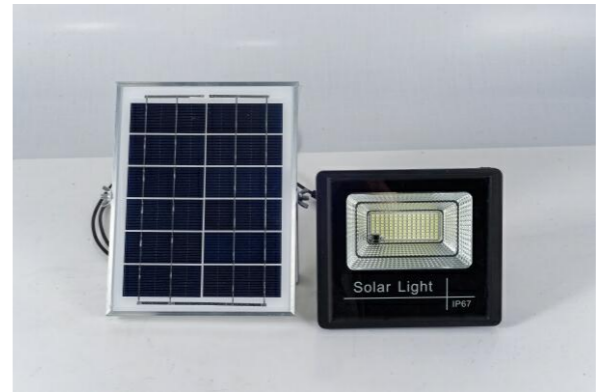

Technical Data 技术参数

Model 型号	BKD-903-50	Battery capacity 电池容量	3.2V/6Ah
Material 材质	Plastic 塑料	Wattage 功率	50W
Solar Panel 太阳能板	High Efficiency solar panel 高效光伏板6V/10W	Discharge Time 放电时间	10-20hrs
Working Mode 亮灯方式	Segmented time control 分段时控	Charge Time 充电时间	6-9hrs
LED Brand 芯片	LED 灯珠	IP Rating	Ip65
Life Time 寿命	>50000hrs	Working Temperature(°C) 工作温度	-40°C~+70°C
Product Size(mm) 产品尺寸	190*147*45mm	Install Height(m) 安装高度	3M
Packing Size 包装尺寸	78*22.5*36.5cm	20GP	8305
Net Weight 净重	35.2kg	40GP	16610
Gross Weight 毛重	36kg	40HQ	20169



配置升级 遥控加持

Configuration upgrade remote control

Solar flood light

100W

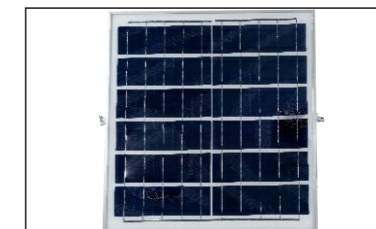

Technical Data 技术参数

Model 型号	BKD-903-100	Battery capacity 电池容量	3.2V/12Ah
Material 材质	Plastic 塑料	Wattage 功率	100W
Solar Panel 太阳能板	High Efficiency solar panel 高效光伏板6V/20W	Discharge Time 放电时间	10-20hrs
Working Mode 亮灯方式	Segmented time control 分段时控	Charge Time 充电时间	6-9hrs
LED Brand 芯片	LED 灯珠	IP Rating	Ip65
Life Time 寿命	>50000hrs	Working Temperature(°C) 工作温度	-40°C~+70°C
Product Size(mm) 产品尺寸	230*185*45mm	Install Height(m) 安装高度	3M
Packing Size 包装尺寸	40*25.5*47.5cm 37.5*28*38cm	20GP	3011
Net Weight 净重	1.76kg	40GP	6022
Gross Weight 毛重	1.8kg	40HQ	7312

Solar flood light
—200W



Technical Data 技术参数

Model 型号	BKD-903-200	Battery capacity 电池容量	3.2V/18Ah
Material 材质	Plastic 塑料	Wattage 功率	200W
Solar Panel 太阳能板	High Efficiency solar panel 高效光伏板6V/30W	Discharge Time 放电时间	10-20hrs
Working Mode 亮灯方式	Segmented time control 分段时控	Charge Time 充电时间	6-9hrs
LED Brand 芯片	LED 灯珠	IP Rating	Ip65
Life Time 寿命	>50000hrs	Working Temperature(°C) 工作温度	-40°C~+70°C
Product Size(mm) 产品尺寸	257*210*62mm	Install Height(m) 安装高度	6-8M
Packing Size 包装尺寸	39*28*46cm 37.5*31*48cm	20GP	2509
Net Weight 净重	2.86kg	40GP	5017
Gross Weight 毛重	3.06kg	40HQ	6093

Solar flood light
—300W



Technical Data 技术参数

Model 型号	BKD-903-300	Battery capacity 电池容量	3.2V/24Ah
Material 材质	Plastic 塑料	Wattage 功率	300W
Solar Panel 太阳能板	High Efficiency solar panel 高效光伏板6V/35W	Discharge Time 放电时间	10-20hrs
Working Mode 亮灯方式	Segmented time control 分段时控	Charge Time 充电时间	6-9hrs
LED Brand 芯片	LED 灯珠	IP Rating	Ip65
Life Time 寿命	>50000hrs	Working Temperature(°C) 工作温度	-40°C~+70°C
Product Size(mm) 产品尺寸	305*235*73mm	Install Height(m) 安装高度	3M
Packing Size 包装尺寸	49.5*32*24cm 55*28*38cm	20GP	2755
Net Weight 净重	4.22kg	40GP	5511
Gross Weight 毛重	4.02kg	40HQ	6692



NUWEN SOLAR LIGHTS



NUWEN CO.,LTD

**ADD:UNIT 1,NO.187,XIAYANG ROAD,HETANG TOWN PENGJIANG,
DISTRICT,JIANGMEN CITY,GUANGDONG, PROVINCE,CHINA.**

E-EMAIL:1 1 4 6 1 5 6 5 5 2@QQ.COM

MOBILE:+86-1 8 6 8 0 5 7 7 9 7 7

WECHAT/WHATS APP:+86-1 8 6 8 0 5 7 7 9 7 7

