



LED STREET LIGHT

NUWEN CO.,LTD

Add:Unit 1,no.187,Xiayang road,Hetang Town ,Pengjiang District,Jiangmen City,Guangdong Province , China.

E-mail: nuwen.china.2020@gmail.com

Mobile: +86-18680577977

WeChat/Whats app: +86-18680577977



+86-18680577977





128 Series flood light and street light



OVERVIEW



- Streetlight Model
- Small U Bracket
- Big U Bracket



Optional sensor
0~10V dimming

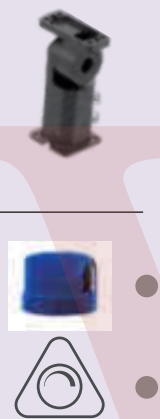

ADJUSTMENT DESIGN

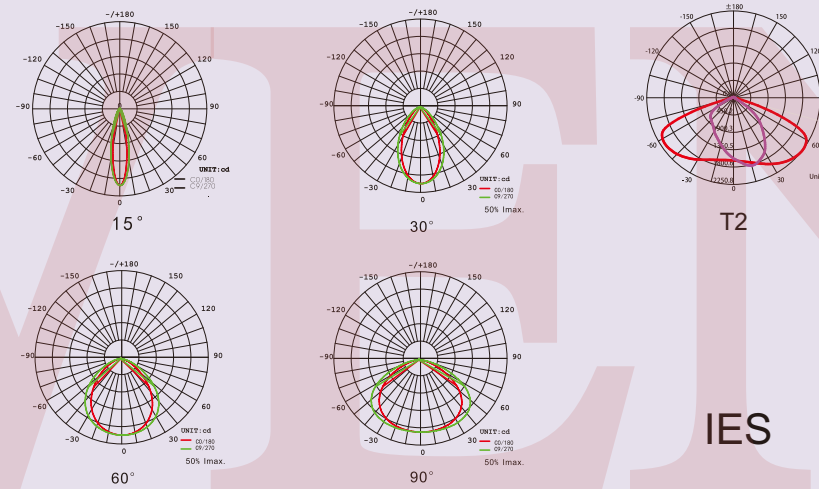

INSTALLATION



Street Light

Surge protection 6KV IP66 CE IK08 LED

Model	Power	Size	Chip qty	Chip size	Lumen	Voltage	Beam Angle	CCT	CRI
KH-SL-S128-100W-G-SMD	100W	460*288*63mm	216pcs	SMD3030	160LM/W	AC100-277V	142°*52°,150°*75°	2700-6500K	>70
KH-SL-S128-200W-G-SMD	200W	528*337*63mm	384pcs	SMD3030	160LM/W	AC100-277V	142°*52°,150°*75°	2700-6500K	>70
KH-SL-S128-300W-G-SMD	300W	622*402*63cm	600pcs	SMD3030	160LM/W	AC100-277V	142°*52°,150°*75°	2700-6500K	>70
KH-SL-S128-400W-G-SMD	400W	676*452*63cm	864pcs	SMD3030	160LM/W	AC100-277V	142°*52°,150°*75°	2700-6500K	>70

Flood Light

Model	Power	Size	Chip qty	Chip size	Lumen	Voltage	Beam Angle	CCT	CRI
KH-FL-S128-100W-G-SMD	100W	460*288*63mm	216pcs	SMD3030	160LM/W	AC100-277V	15° 30° 60° 90°, 120°, 150°	2700-6500K	>70
KH-FL-S128-200W-G-SMD	200W	528*337*63mm	384pcs	SMD3030	160LM/W	AC100-277V	15° 30° 60° 90°, 120°, 150°	2700-6500K	>70
KH-FL-S128-300W-G-SMD	300W	622*402*63cm	600pcs	SMD3030	160LM/W	AC100-277V	15° 30° 60° 90°, 120°, 150°	2700-6500K	>70
KH-FL-S128-400W-G-SMD	400W	676*452*63cm	864pcs	SMD3030	160LM/W	AC100-277V	15° 30° 60° 90°, 120°, 150°	2700-6500K	>70





PHILIPS

5 Years Warranty

- 0~10V dimming
- Optional sensor

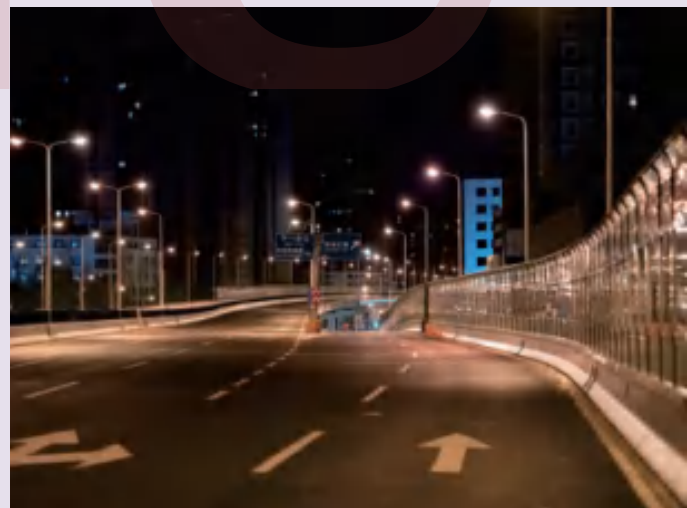

Surge protection 6KV IP65 CE IK08 LED

Model	Power	Size	Chip qty	Chip size	Lumen	Voltage	Beam Angle	CCT	CRI
KH-SL-S126-50W-G-SMD	50W	511*180*113mm	72pcs	SMD3030	150LM/W	AC100-277V	T1, T2, T2M, T3	2700-6500K	>70
KH-SL-S126-100W-G-SMD	100W	585*230*100mm	144pcs	SMD3030	150LM/W	AC100-277V	T1, T2, T2M, T3	2700-6500K	>70
KH-SL-S126-150W-G-SMD	150W	635*230*100cm	192pcs	SMD3030	150LM/W	AC100-277V	T1, T2, T2M, T3	2700-6500K	>70
KH-SL-S126-200W-G-SMD	200W	738*288*100cm	240pcs	SMD3030	150LM/W	AC100-277V	T1, T2, T2M, T3	2700-6500K	>70



PHILIPS

5 Years Warranty

5 Years Warranty



- Optional sensor
- 0~10V dimming

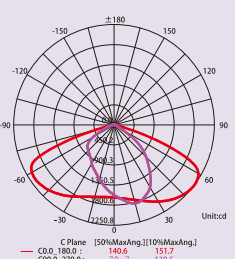

Surge protection 6KV IP65 CE IK08 LED

Model	Power	Size	Chip qty	Chip size	Lumen	Voltage	Beam Angle	CCT	CRI
KH-SL-S127-100W-G-SMD	100W	580*310*135mm	128pcs	SMD3030	170LM/W	AC100-277V	140*70°	2700-6500K	>70
KH-SL-S127-150W-G-SMD	150W	730*310*135mm	192pcs	SMD3030	170LM/W	AC100-277V	140*70°	2700-6500K	>70
KH-SL-S127-200W-G-SMD	200W	660*260*70mm	256pcs	SMD3030	170LM/W	AC100-277V	140*70°	2700-6500K	>70
KH-SL-S127-250W-G-SMD	250W	810*310*135mm	320pcs	SMD3030	170LM/W	AC100-277V	140*70°	2700-6500K	>70



MW
MEAN WELL
PHILIPS
LUMILED
5 Years
Warranty

MW
MEAN WELL
PHILIPS
LUMILED
5 Years
Warranty

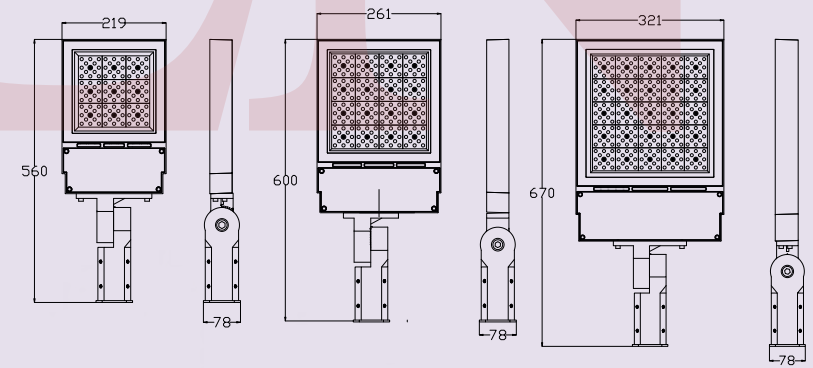
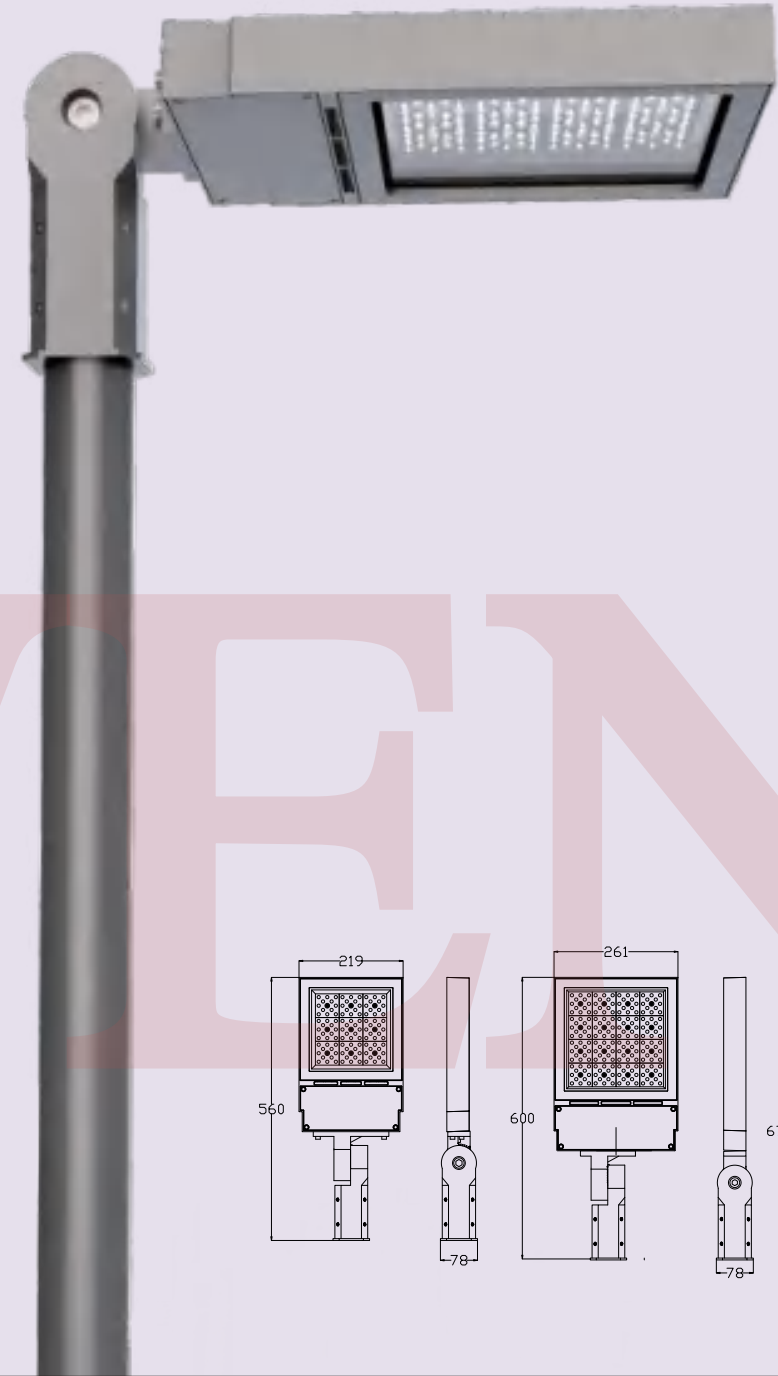

Street Light

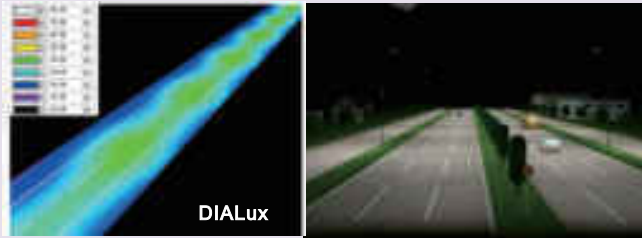
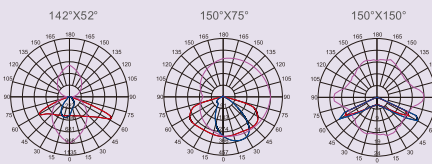
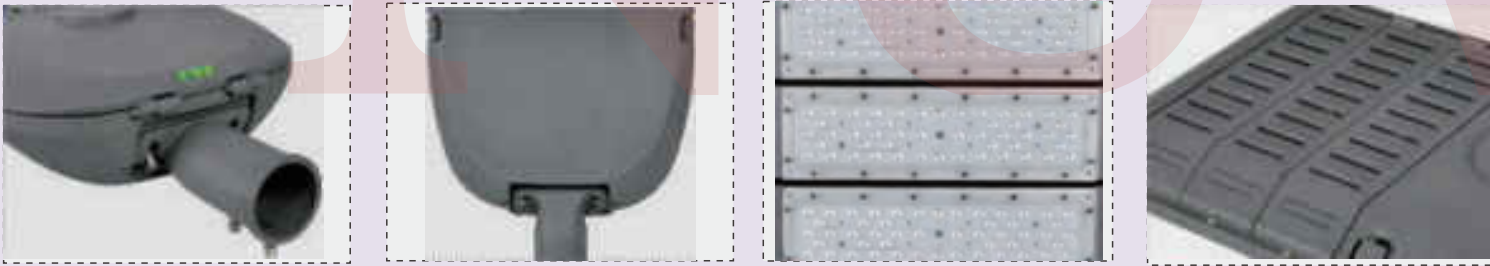

Surge protection 6KV

IP65 CE IK08 LED

Model	Power	Size	Chip qty	Chip size	Lumen	Voltage	Beam Angle	CCT	CRI
KH-SL-S078-50W-G-SMD	50W	620*315*135mm	56pcs	SMD 3030	6000lm	AC100-265V	135°70°	2800-6500K	≥70
KH-SL-S078-100W-G-SMD	100W	650*350*135mm	112pcs	SMD 3030	12000lm	AC100-265V	135°70°	2800-6500K	≥70
KH-SL-S078-150W-G-SMD	150W	730*350*135mm	168pcs	SMD 3030	18000lm	AC100-265V	135°70°	2800-6500K	≥70
KH-SL-S078-200W-G-SMD	200W	810*350*135mm	224pcs	SMD 3030	24000lm	AC100-265V	135°70°	2800-6500K	≥70
KH-SL-S078-250W-G-SMD	250W	890*350*135mm	280pcs	SMD 3030	30000lm	AC100-265V	135°70°	2800-6500K	≥70
KH-SL-S078-300W-G-SMD	300W	970*350*135mm	336pcs	SMD 3030	36000lm	AC100-265V	135°70°	2800-6500K	≥70

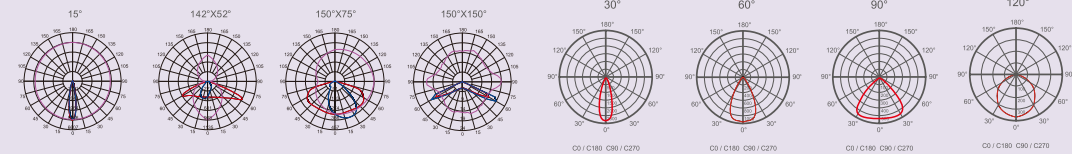

Surge protection 6KV

IP65 CE IK08 LED

Model	Power	Size	Lens	Chip qty	Chip size	Lumen	Voltage	Beam Angle	CCT	CRI
KH-SL-S068-50W-G-SMD	50W	560*219*50mm	8in1	72pcs	Philips3030	130lm/W	AC100-265V	15°/30°/60°/90°/120°/150°/90X90°/142X52°/150X150°/150X75	2700-6500K	>80
KH-SL-S068-80W-G-SMD-A	80W	560*219*50mm	12in1	108pcs	Philips3030	130lm/W	AC100-265V	15°/30°/60°/90°/120°/150°/90X90°/142X52°/150X150°/150X75	2700-6500K	>80
KH-SL-S068-80W-G-SMD-B	80W	560*219*50mm	16in1	144pcs	Philips3030	150lm/W	AC100-265V	15°/30°/60°/90°/120°/150°/90X90°/142X52°/150X150°/150X75	2700-6500K	>80
KH-SL-S068-100W-G-SMD	100W	600*261*50mm	8in1	128pcs	Philips3030	130lm/W	AC100-265V	15°/30°/60°/90°/120°/150°/90X90°/142X52°/150X150°/150X75	2700-6500K	>80
KH-SL-S068-150W-G-SMD-A	150W	600*261*50mm	12in1	192pcs	Philips3030	130lm/W	AC100-265V	15°/30°/60°/90°/120°/150°/90X90°/142X52°/150X150°/150X75	2700-6500K	>80
KH-SL-S068-150W-G-SMD-B	150W	600*261*50mm	16in1	256pcs	Philips3030	150lm/W	AC100-265V	15°/30°/60°/90°/120°/150°/90X90°/142X52°/150X150°/150X75	2700-6500K	>80
KH-SL-S068-200W-G-SMD	200W	670*321*50mm	8in1	200pcs	Philips3030	130lm/W	AC100-265V	15°/30°/60°/90°/120°/150°/90X90°/142X52°/150X150°/150X75	2700-6500K	>80
KH-SL-S068-250W-G-SMD-A	250W	670*321*50mm	12in1	300pcs	Philips3030	130lm/W	AC100-265V	15°/30°/60°/90°/120°/150°/90X90°/142X52°/150X150°/150X75	2700-6500K	>80
KH-SL-S068-250W-G-SMD-B	250W	670*321*50mm	16in1	400pcs	Philips3030	150lm/W	AC100-265V	15°/30°/60°/90°/120°/150°/90X90°/142X52°/150X150°/150X75	2700-6500K	>80



5 Years Warranty



5 Years Warranty



Surge protection 6KV IK08 LED

Surge protection 6KV IK08 LED

Model	Power	Size	Chip qty	Chip size	Lumen	Voltage	Beam Angle	CCT	CRI
KH-SL-S116-50W-G-SMD	50W	525*192*98mm	96pcs	SMD3030	170LM/W	AC100-277V	150*75°	2700-6500K	>70
KH-SL-S116-100W-G-SMD	100W	546*220*98cm	144pcs	SMD3030	170LM/W	AC100-277V	150*75°	2700-6500K	>70
KH-SL-S116-150W-G-SMD	150W	636*250*98cm	240pcs	SMD3030	170LM/W	AC100-277V	150*75°	2700-6500K	>70
KH-SL-S116-200W-G-SMD	200W	901*310*98cm	320pcs	SMD3030	170LM/W	AC100-277V	150*75°	2700-6500K	>70
KH-SL-S116-240W-G-SMD	200W	901*310*98cm	320pcs	SMD3030	170LM/W	AC100-277V	150*75°	2700-6500K	>70

Model	Power	Size	Chip qty	Chip size	Lumen	Voltage	Beam Angle	CCT	CRI
KH-SL-S124-50W-G-SMD	50W	520*210*70mm	76pcs	SMD3030	170LM/W	AC85-265V	140*70°	2700-6500K	>70
KH-SL-S124-100W-G-SMD	100W	560*260*70mm	144pcs	SMD3030	170LM/W	AC85-265V	140*70°	2700-6500K	>70
KH-SL-S124-150W-G-SMD	150W	660*260*70mm	240pcs	SMD3030	170LM/W	AC85-265V	140*70°	2700-6500K	>70
KH-SL-S124-200W-G-SMD	200W	720*260*70mm	288pcs	SMD3030	170LM/W	AC85-265V	140*70°	2700-6500K	>70

5 Years Warranty



50W 100W 150W 200W



140*70°

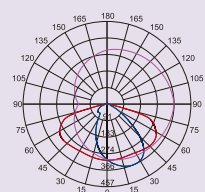

Surge protection 6KV

IP65 CE IK08 LED

Model	Power	Size	Chip qty	Chip size	Lumen	Voltage	Beam Angle	CCT	CRI
KH-SL122-50W-G-SMD	50W	600*230*93cm	96pcs	SMD3030	170LM/W	AC100-277V	140*70°	2700-6500K	>70
KH-SL122-100W-G-SMD	100W	650*230*93cm	144pcs	SMD3030	170LM/W	AC100-277V	140*70°	2700-6500K	>70
KH-SL122-150W-G-SMD	150W	754*280*93cm	240pcs	SMD3030	170LM/W	AC100-277V	140*70°	2700-6500K	>70
KH-SL122-200W-G-SMD	200W	855*280*93cm	320pcs	SMD3030	170LM/W	AC100-277V	140*70°	2700-6500K	>70



65*135°

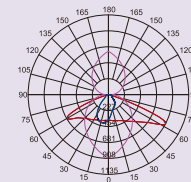

IP65 CE IK08 LED

Model	Power	Size	Chip qty	Chip size	Lumen	Voltage	Beam Angle	CCT	CRI
KH-SL120-50W-G-SMD	50W	460*131*73cm	72pcs	SMD3030	140LM/W	AC85-265V	65*135°	2700-6500K	>70
KH-SL120-100W-G-SMD	100W	521*146*73cm	144pcs	SMD3030	140LM/W	AC85-265V	65*135°	2700-6500K	>70
KH-SL120-150W-G-SMD	150W	581*167*73cm	216pcs	SMD3030	140LM/W	AC85-265V	65*135°	2700-6500K	>70
KH-SL120-200W-G-SMD	200W	656*196*73cm	288pcs	SMD3030	140LM/W	AC85-265V	65*135°	2700-6500K	>70

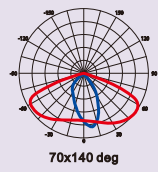

IP65 CE IK08 LED

Model	Power	Size	Chip qty	Chip size	Lumen	Voltage	Beam Angle	CCT	CRI
KH-SL-S115-30W-G-SMD	30W	501x127x78mm	60pcs	SMD2835	4,800lm	AC85-265V	70°*140°	2700-6500K	>70
KH-SL-S115-50W-G-SMD	50W	549x147x78mm	96pcs	SMD2835	8,000lm	AC85-265V	70°*140°	2700-6500K	>70
KH-SL-S115-100W-G-SMD	100W	589x207x78mm	196pcs	SMD2835	16,000lm	AC85-265V	70°*140°	2700-6500K	>70
KH-SL-S115-150W-G-SMD	150W	699x222x78mm	280pcs	SMD2835	24,000lm	AC85-265V	70°*140°	2700-6500K	>70
KH-SL-S115-200W-G-SMD	200W	719x237x78mm	392pcs	SMD2835	32,000lm	AC85-265V	70°*140°	2700-6500K	>70
KH-SL-S115-250W-G-SMD	250W	719x237x78mm	392pcs	SMD2835	37,500lm	AC85-265V	70°*140°	2700-6500K	>70





OPTICS

Tech. Support: Tell us the room length, width, height and the usage. We have an engineer team to respond the DIALUX simulations for lights quantity calculation and effects. ies files are available upon request.

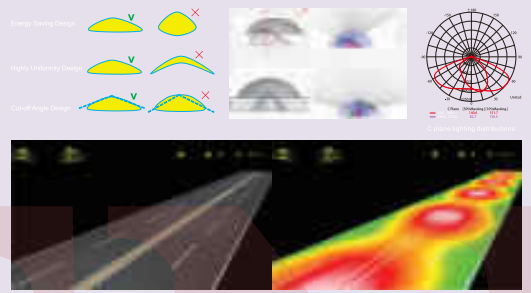

Tool-free operation

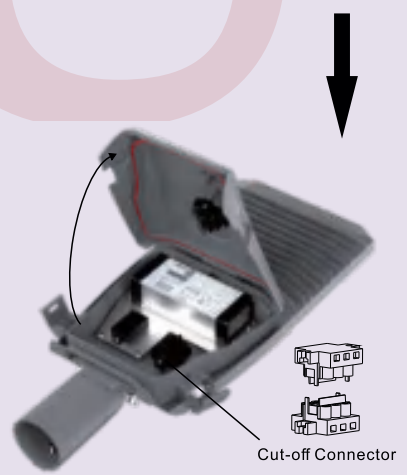
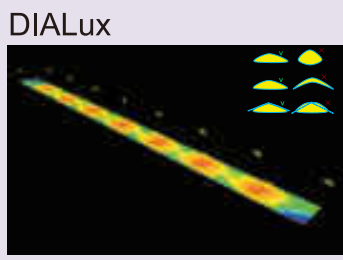
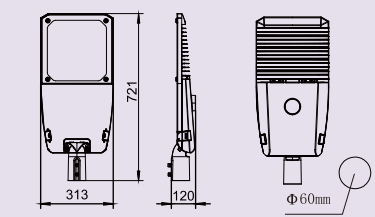
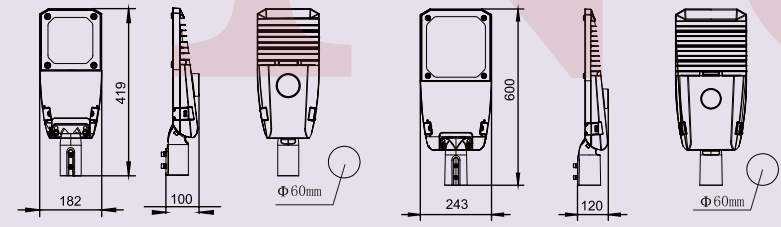

Large space for LED drivers

INSTALLATION

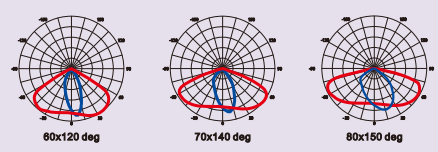
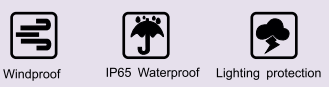
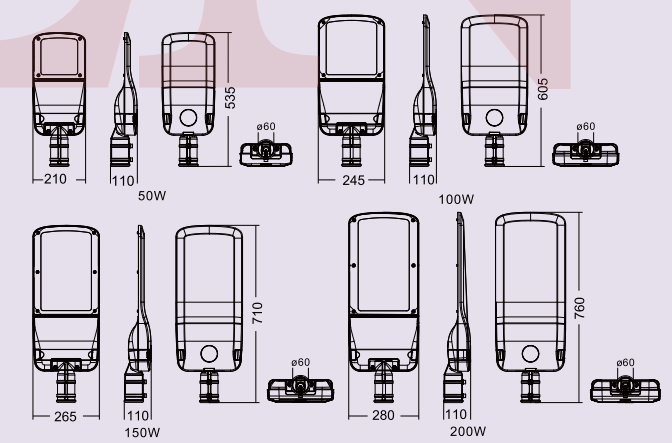
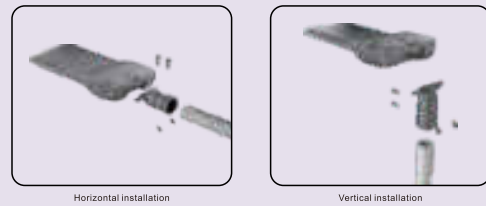

IP66 CE IK08 LED



IP65 CE IK08 LED

Model	Power	Size	Chip qty	Chip size	Lumen	Voltage	Beam Angle	CCT	CRI
KH-SL-S104-50W-G-SMD	50W	535x210x110mm	64pcs	SMD3030	6,500lm	AC85-265V	T2,T3,T4	2700-6500K	>70
KH-SL-S104-100W-G-SMD	100W	605x245x110mm	144pcs	SMD3030	13,000lm	AC85-265V	T2,T3,T4	2700-6500K	>70
KH-SL-S103-100W-G-SMD	100W	600x243x120mm	144pcs	SMD3030	13,000lm	AC85-265V	T2,T3,T4	2700-6500K	>70
KH-SL-S104-150W-G-SMD	150W	710x265x110mm	192pcs	SMD3030	19,500lm	AC85-265V	T2,T3,T4	2700-6500K	>70
KH-SL-S103-150W-G-SMD	150W	721x313x120mm	192pcs	SMD3030	19,500lm	AC85-265V	T2,T3,T4	2700-6500K	>70
KH-SL-S104-200W-G-SMD	200W	760x280x110MM	256pcs	SMD3030	26,000lm	AC85-265V	T2,T3,T4	2700-6500K	>70
KH-SL-S103-200W-G-SMD	200W	721x313x120mm	256pcs	SMD3030	26,000lm	AC85-265V	T2,T3,T4	2700-6500K	>70

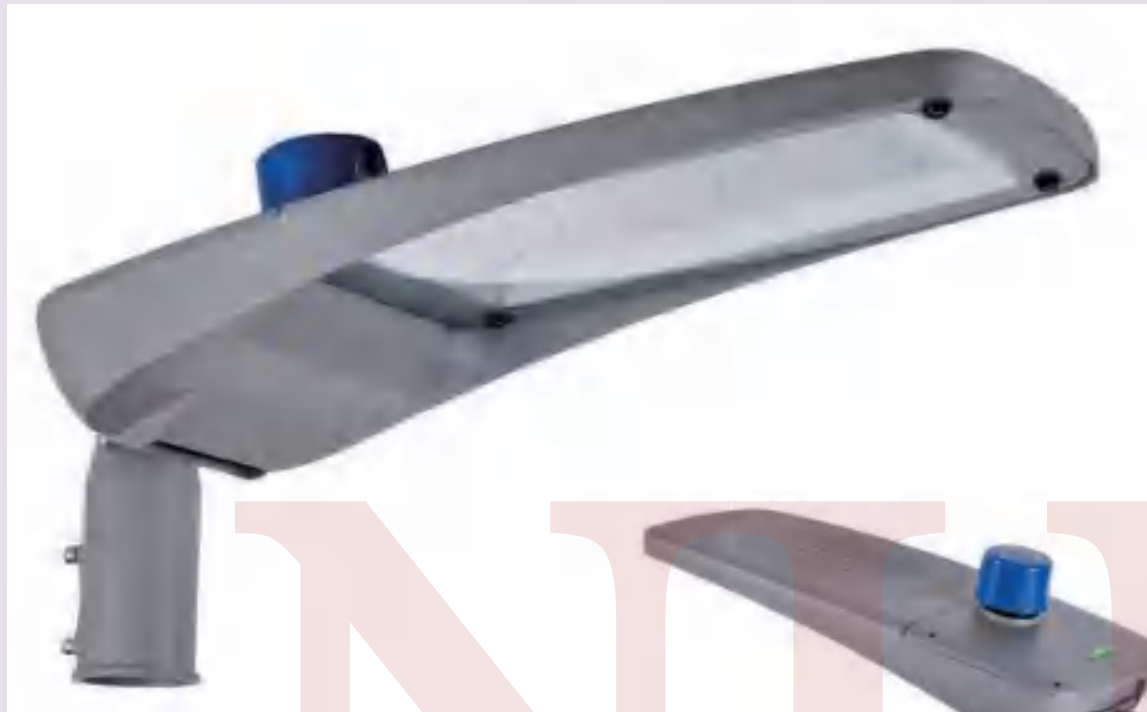

Size

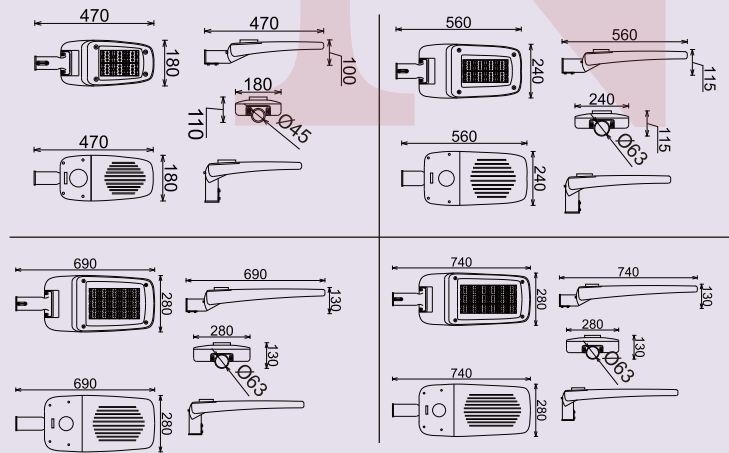

50W 100W 150W 200W

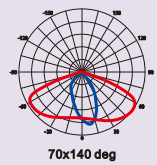

70x140 deg

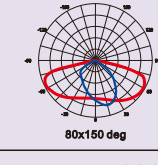

80x150 deg

IP65 CE IK08 LED

IP65 CE IK08 LED

Model	Power	Size	Chip qty	Chip size	Lumen	Voltage	Beam Angle	CCT	CRI
KH-SL-S105-50W-G-SMD	50W	470x180x110mm	60pcs	SMD3030	6,500lm	AC85-265V	70*140°	2700-6500K	>70
KH-SL-S105-100W-G-SMD	100W	560x240x115mm	96pcs	SMD3030	13,000lm	AC85-265V	70*140°	2700-6500K	>70
KH-SL-S105-150W-G-SMD	150W	690x280x130mm	150pcs	SMD3030	19,500lm	AC85-265V	70*140°	2700-6500K	>70
KH-SL-S105-200W-G-SMD	200W	740x280x130mm	216pcs	SMD3030	26,000lm	AC85-265V	70*140°	2700-6500K	>70

Model	Power	Size	Chip qty	Chip size	Lumen	Voltage	Beam Angle	CCT	CRI
KH-SL-S109-50W-G-SMD	50W	220x515x85mm	96pcs	SMD3030	7,500lm	AC85-265V	75x150°	2700-6500K	>70
KH-SL-S109-100W-G-SMD	100W	220x565x85mm	144pcs	SMD3030	15,000lm	AC85-265V	75x150°	2700-6500K	>70
KH-SL-S109-150W-G-SMD	150W	240x635x85mm	240pcs	SMD3030	22,500lm	AC85-265V	75x150°	2700-6500K	>70
KH-SL-S109-200W-G-SMD	200W	290x665x85mm	320pcs	SMD3030	30,000lm	AC85-265V	75x150°	2700-6500K	>70

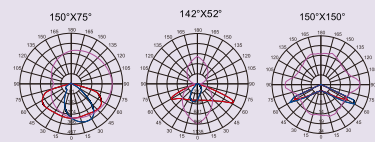
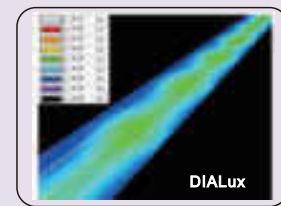
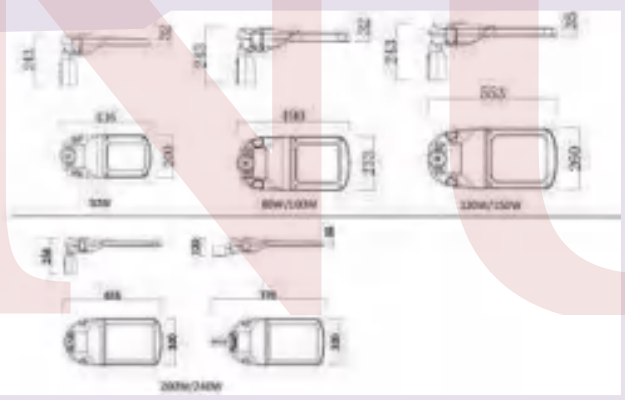
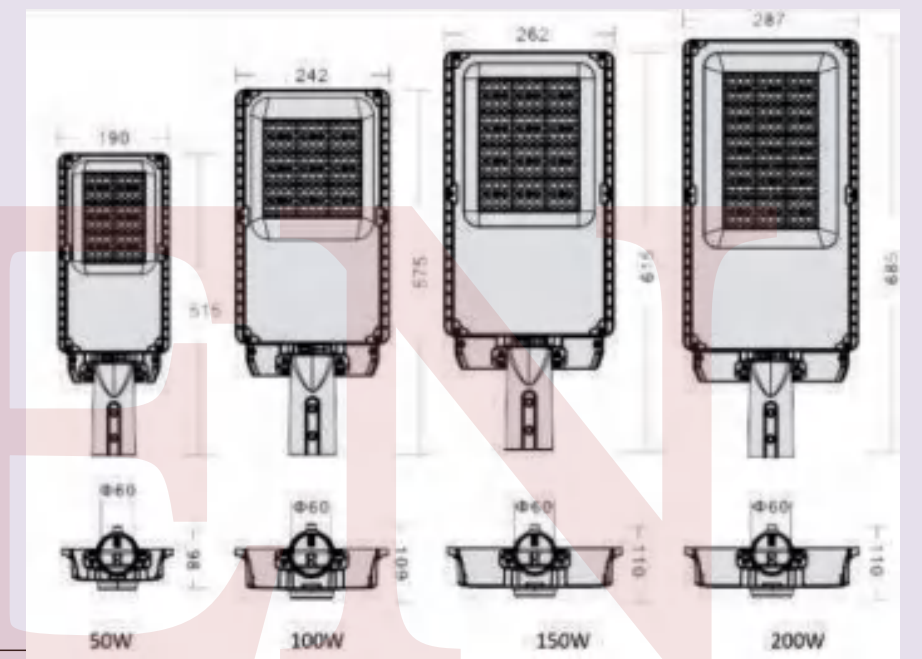

Surge protection 6KV
IP65 CE IK08 LED

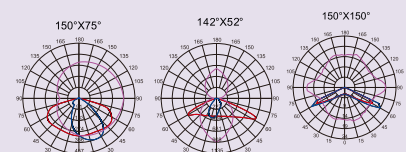

Surge protection 6KV
IP65 CE IK08 LED

Model	Power	Size	Chip qty	Chip size	Lumen	Voltage	Beam Angle	CCT	CRI
KH-SL-S062-50W-B-SMD	50W	436*243*120MM	72pcs	SMD 3030	6,500lm	AC100-265V	T2 T3 T4 T5	2700-6500K	>70
KH-SL-S062-80W-B-SMD	80W	583*244*120MM	108PCS	SMD 3030	10,400lm	AC100-265V	T2 T3 T4 T5	2700-6500K	>70
KH-SL-S062-100W-B-SMD	100W	583*244*120MM	144PCS	SMD 3030	13,000lm	AC100-265V	T2 T3 T4 T5	2700-6500K	>70
KH-SL-S062-120W-B-SMD	120W	673*260*120MM	144PCS	SMD 3030	15,600lm	AC100-265V	T2 T3 T4 T5	2700-6500K	>70
KH-SL-S062-150W-B-SMD	150W	673*260*122MM	192PCS	SMD 3030	19,500lm	AC100-265V	T2 T3 T4 T5	2700-6500K	>70
KH-SL-S062-200W-B-SMD	200W	775*320*120MM	240PCS	SMD 3030	26,000lm	AC100-265V	T2 T3 T4 T5	2700-6500K	>70
KH-SL-S062-240W-B-SMD	240W	775*320*120MM	320PCS	SMD 3030	31,200lm	AC100-265V	T2 T3 T4 T5	2700-6500K	>70

Model	Power	Size	Chip qty	Chip size	Lumen	Voltage	Beam Angle	CCT	CRI
KH-SL-S093-50W-G-SMD	50W	515*190*98mm	96pcs	SMD 3030	6500lm	AC100-265V	T2M,T3M,T4M,60,90,70*140	2800-6500K	≥70
KH-SL-S093-100W-G-SMD	100W	575*242*109mm	144pcs	SMD 3030	13000lm	AC100-265V	T2M,T3M,T4M,60,90,70*140	2800-6500K	≥70
KH-SL-S093150W-G-SMD	150W	615*262*110mm	192pcs	SMD 3030	19500lm	AC100-265V	T2M,T3M,T4M,60,90,70*140	2800-6500K	≥70
KH-SL-S093-200W-G-SMD	200W	685*287*110mm	240pcs	SMD 3030	26000lm	AC100-265V	T2M,T3M,T4M,60,90,70*140	2800-6500K	≥70

186-180-80577977

MW
MEAN WELL
PHILIPS
5 Years
Warranty

MW
MEAN WELL
PHILIPS
5 Years
Warranty

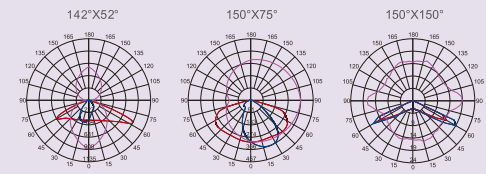

Surge protection 6KV

IP65 CE IK08 LED

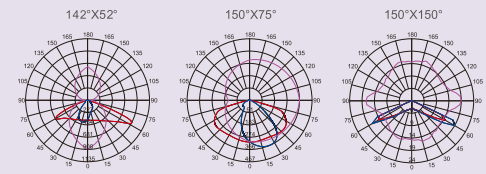

Surge protection 6KV

IP65 CE IK08 LED

Model	Power	Size	Chip qty	Chip size	Lumen	Voltage	Beam Angle	CCT	CRI
KH-SL-S088-50W-G-SMD	50W	483*230*127MM	96pcs	PHILIPS LUMILED 3030	6500lm	AC100-277V	150°75 T2/150°40 T3 143°85 T4/150°150 T5	2700-6500K	>70
KH-SL-S088-100W-G-SMD	100W	548*230*127MM	144PCS	PHILIPS LUMILED 3030	13000lm	AC100-277V	150°75 T2/150°40 T3 143°85 T4/150°150 T5	2700-6500K	>70
KH-SL-S088-150W-G-SMD	150W	598*257*129MM	192PCS	PHILIPS LUMILED 3030	19500lm	AC100-277V	150°75 T2/150°40 T3 143°85 T4/150°150 T5	2700-6500K	>70
KH-SL-S088-200W-G-SMD	200W	655*320*131MM	320PCS	PHILIPS LUMILED 3030	26000lm	AC100-277V	150°75 T2/150°40 T3 143°85 T4/150°150 T5	2700-6500K	>70

Model	Power	Size	Chip qty	Chip size	Lumen	Voltage	Beam Angle	CCT	CRI
KH-SL-S089-50W-G-SMD	50W	408*230*106mm	80pcs	PHILIPS LUMILED 3030	6500lm	AC100-277V	150°75 T2/150°40 T3 143°85 T4/150°150 T5	2700-6500K	>70
KH-SL-S089-100W-G-SMD	100W	509*230*105mm	160pcs	PHILIPS LUMILED 3030	13000lm	AC100-277V	150°75 T2/150°40 T3 143°85 T4/150°150 T5	2700-6500K	>70
KH-SL-S089-150W-G-SMD	150W	600*257*108mm	240pcs	PHILIPS LUMILED 3030	19500lm	AC100-277V	150°75 T2/150°40 T3 143°85 T4/150°150 T5	2700-6500K	>70
KH-SL-S089-200W-G-SMD	200W	700*257*108mm	320pcs	PHILIPS LUMILED 3030	26000lm	AC100-277V	150°75 T2/150°40 T3 143°85 T4/150°150 T5	2700-6500K	>70

+86-18680577977



LED STREET LIGHT

IP66

WORKING TEMPERATURE RANGE: -20°C ~ 30°C

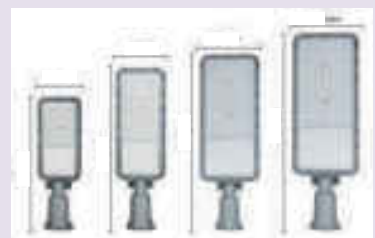
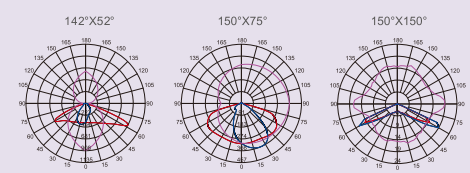

Surge protection 6KV
 IP65 CE IK08 LED

Model	Power	Size	Chip qty	Chip size	Lumen	Voltage	Beam Angle	CCT	CRI
KH-SL101-50W-G-SMD	50W	460*120*70mm	72pcs	3030	5000lm	AC85-265V	135x60°	2800x6500K	≥70
KH-SL101-100W-G-SMD	100W	510*140*70mm	120pcs	3030	10000lm	AC85-265V	135x60°	2800x6500K	≥70
KH-SL101-150W-G-SMD	150W	581*160*70mm	168pcs	3030	15000lm	AC85-265V	135x60°	2800x6500K	≥70
KH-SL101-200W-G-SMD	200W	641*180*70mm	340pcs	3030	20000lm	AC85-265V	135x60°	2800x6500K	≥70

MW MEAN WELL
PHILIPS
5 Years Warranty

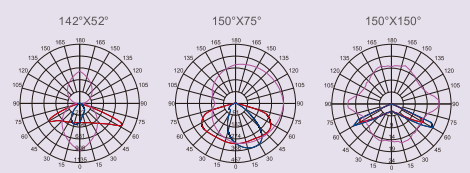
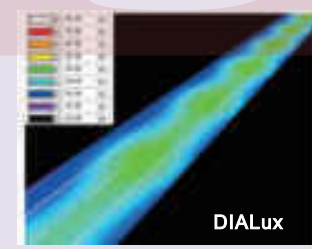
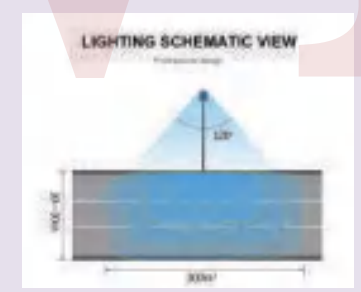

Surge protection 6KV
 IP65 CE IK08 LED

Model	Power	Size	Chip qty	Chip size	Lumen	Voltage	Beam Angle	CCT	CRI
KH-SL-S055-30W-G-SMD	30W	507*210*143mm	36pcs	SMD 3030	3600lm	AC100-277V	T2M,T3M,T4M	2800-6500K	≥70
KH-SL-S055-60W-G-SMD	60W	507*210*143mm	72pcs	SMD 3030	7800lm	AC100-277V	T2M,T3M,T4M	2800-6500K	≥70
KH-SL-S055-80W-G-SMD	80W	616*259*186mm	96pcs	SMD 3030	10400lm	AC100-277V	T2M,T3M,T4M	2800-6500K	≥70
KH-SL-S055-120W-G-SMD	120W	676*303*186mm	144pcs	SMD 3030	15600lm	AC100-277V	T2M,T3M,T4M	2800-6500K	≥70
KH-SL-S055-150W-G-SMD	150W	676*303*186mm	180pcs	SMD 3030	19500lm	AC100-277V	T2M,T3M,T4M	2800-6500K	≥70
KH-SL-S055-200W-G-SMD	200W	850*366*198mm	240pcs	SMD 3030	26000lm	AC100-277V	T2M,T3M,T4M	2800-6500K	≥70

PRODUCT DETAILS

HIGH QUALITY DRIVER

UNIQUE DESIGN LED CHIP

BEST HEAT DISSIPATION PERFORMANCE

DIE-CASTING ALUMINUM WELDER

WATERPROOF

OPTIONAL INTALLATION OF PHOTOCELL

INTELLIGENT INDUCTIVE LIGHT CONTROL

Turn off during the day and automatically light-up at night

+86-18680577977



Product Structure Diagram

LED Lamp beads
High quality highlight
provides longer life,
more uniform illumination
and more durability

Aluminum die-casting shell

Waterproof rubber ring



DETAIL DRAINING



INSTALLATION DIAGRAM

It can be installed horizontally and vertically as shown in the figure. Wide adjustable angles from 90° to +90° at a time.

1. Install the lamp to the pole and tighten the screw.

2. Loosen the connecting rod converter screw and adjust the angle.

3. Tighten connecting rod converter screws.

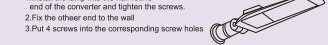

1. Install the lamp into the half round end of the converter and tighten the screws.

2. Fix the other end to the wall.

3. Put 4 screws into the corresponding screw holes.



65*135°

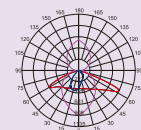

IP65 CE IK08 LED

Model	Power	Size	Chip qty	Chip size	Lumen	Voltage	Beam Angle	CCT	CRI
KH-SL98-30W-G-SMD	30W	345x112.5x60mm	48pcs	SMD3030	3,600lm	AC85-265V	65*135°	2700-6500K	>70
KH-SL98-50W-G-SMD	50W	402x126.5x60mm	72pcs	SMD3030	6,000lm	AC85-265V	65*135°	2700-6500K	>70
KH-SL98-100W-G-SMD	100W	462x141.5x66mm	120pcs	SMD3030	12,000lm	AC85-265V	65*135°	2700-6500K	>70
KH-SL98-150W-G-SMD	150W	532x171.5x75mm	216pcs	SMD3030	18,000lm	AC85-265V	65*135°	2700-6500K	>70
KH-SL98-200W-G-SMD	200W	606x193.5x85mm	288pcs	SMD3030	24,000lm	AC85-265V	65*135°	2700-6500K	>70

65*135°

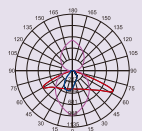

IP65 CE IK08 LED

Model	Power	Size	Chip qty	Chip size	Lumen	Voltage	Beam Angle	CCT	CRI
KH-SL099-50W-G-SMD	50W	530*158*100mm	72pcs	SMD3030	6,500lm	AC85-265V	65*135°	2700-6500K	>70
KH-SL099-100W-G-SMD	100W	583*177*100mm	120pcs	SMD3030	13,000lm	AC85-265V	65*135°	2700-6500K	>70
KH-SL099-150W-G-SMD	150W	645*214*100mm	216pcs	SMD3030	19,500lm	AC85-265V	65*135°	2700-6500K	>70
KH-SL099-200W-G-SMD	200W	717*244*100mm	288pcs	SMD3030	26,000lm	AC85-265V	65*135°	2700-6500K	>70

+86-18080577977



Street Light



IP65 CE IK08 LED

Model	Power	Size	Chip qty	Chip size	Lumen	Voltage	Beam Angle	CCT	CRI
KH-SL-S079-50W-G-SMD-B	50W	480x315x90mm	56W	SMD 3030	6000lm	AC100-265V	135°70°	2800-6500K	≥70
KH-SL-S079-100W-G-SMD-B	100W	540*315*90mm	112pcs	SMD 3030	12000 lm	AC100-265V	135°70°	2800-6500K	≥70
KH-SL-S079-150W-G-SMD-B	150W	620*315*90mm	168pcs	SMD 3030	18000lm	AC100-265V	135°70°	2800-6500K	≥70
KH-SL-S079-200W-G-SMD-B	200W	700*315*90mm	224pcs	SMD 3030	24000lm	AC100-265V	135°70°	2800-6500K	≥70
KH-SL-S079-250W-G-SMD-B	250W	780*315*90mm	280pcs	SMD 3030	30000lm	AC100-265V	135°70°	2800-6500K	≥70
KH-SL-S079-300W-G-SMD-B	300W	620*315*90mm	336pcs	SMD 3030	36000lm	AC100-265V	135°70°	2800-6500K	≥70



Street Light



IP65 CE IK08 LED

Model	Power	Size	Chip qty	Chip size	Lumen	Voltage	Beam Angle	CCT	CRI
KH-SL081-30W-B-SMD	30W	380*172*65mm	36pcs	SMD 3030	3300 lm	AC100-265V	140°70°	2800-6500K	≥70
KH-SL081-50W-B-SMD	50W	420*200*70mm	60pcs	SMD 3030	5500lm	AC100-265V	140°70°	2800-6500K	≥70
KH-SL081-100W-B-SMD	100W	495*215*80mm	120pcs	SMD 3030	11000lm	AC100-265V	140°70°	2800-6500K	≥70
KH-SL081-150W-B-SMD	150W	540*215*80mm	150pcs	SMD 3030	16500lm	AC100-265V	140°70°	2800-6500K	≥70
KH-SL081-200W-B-SMD	200W	600*235*80mm	200pcs	SMD 3030	22000lm	AC100-265V	140°70°	2800-6500K	≥70

+86-18680577977

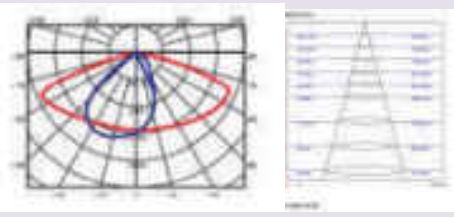
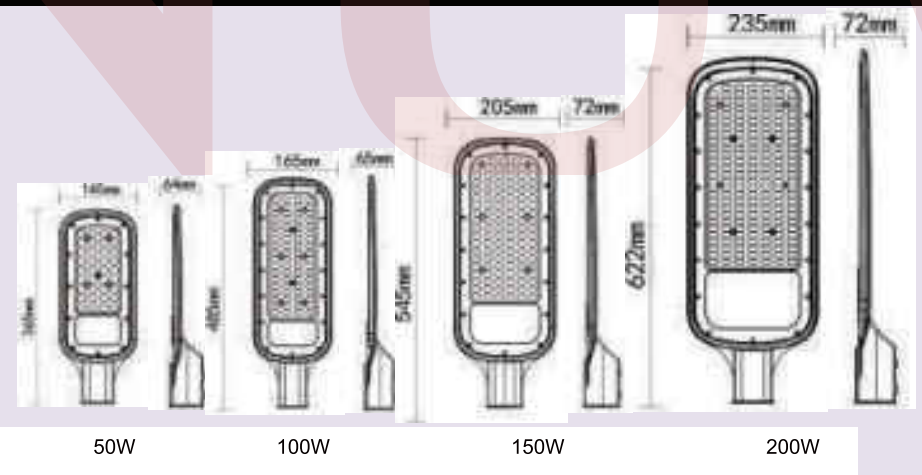

IP65 CE IK08 LED

IP65 CE IK08 LED

Model	Power	Size	Chip qty	Chip size	Lumen	Voltage	Beam Angle	CCT	CRI
KH-SL-S085-50W-G-SMD	50W	365*145*64mm	72pcs	SMD 3030	4500lm	AC170-277V	140*70°	2800-6500K	≥70
KH-SL-S085-100W-G-SMD	100W	485*165*65mm	128pcs	SMD 3030	9000lm	AC170-277V	140*70°	2800-6500K	≥70
KH-SL-S085-150W-G-SMD	150W	545*205*72mm	192pcs	SMD 3030	16200lm	AC170-277V	140*70°	2800-6500K	≥70
KH-SL-S085-200W-G-SMD	200W	622*235*72mm	228pcs	SMD 3030	18000lm	AC170-277V	140*70°	2800-6500K	≥70

Model	Power	Size	Chip qty	Chip size	Lumen	Voltage	Beam Angle	Surge	CCT	CRI
KH-SL094-50W-G-DOB	50W	390*160*75MM	90pcs	SMD 3030	4500lm	AC165-265V/AC100-265V	65x135°	4KV	2700-6500K	>70
KH-SL094-100W-G-DOB	100W	470*200*75MM	144PCS	SMD 3030	9000lm	AC165-265V/AC100-265V	65x135°	4KV	2700-6500K	>70
KH-SL094-150W-G-DOB	150W	530*220*75MM	216PCS	SMD 3030	16200lm	AC165-265V/AC100-265V	65x135°	4KV	2700-6500K	>70
KH-SL094-200W-G-DOB	200W	600*250*75MM	252PCS	SMD3030	18000lm	AC165-265V/AC100-265V	65x135°	4KV	2700-6500K	>70

+86-18680577977

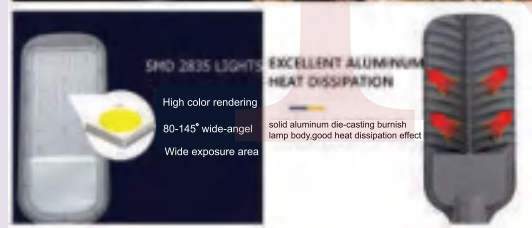

Specification
Power: 30W-100W
Voltage: Non-isolated AC100-265V
Lumen: 100lm/w (Sanan Chips)

WATERPROOF
IP65 water-proof, dust-proof
Dusk-to-Dawn photocell sensor option

COMPACT DESIGN
Attractive looking,
Good heat dissipation,
Easy installation
Cost effective

APPLICATION
Used for parking lot,
street, garden, yard, etc.

20W 30W 50W 100W

ALUMINUM HOUSING
Waterproof connector, use peace of mind, long life

3030 SMD
High light efficiency, heat dissipation faster.

LED STREET LIGHT DRIVER
BIS CE EMC DRIVER CAN BE CHOSED
80-277V Input Voltage, 350V can be test 2H
PF: >0.95
Surge: 4KV/ 6KV can choose
2/3/5 years warranty
IP67

VARIETY OF BEAM ANGLE
Beam angle 120°/60°

FIXED SCREW
All-round fixed bracket, not afraid of wind and rain, safe and firm.

WATERPROOF IP66
Waterproof factor IP66, effectively prevent the infiltration of rain



IP65 CE IK08 LED

Model	Power	Size	Chip qty	Chip size	Lumen	Voltage	Beam Angle	CCT	CRI
KH-SL-S076-20W-B-SMD	20W	300*104*45mm	20pcs	SMD 3030	2000lm	AC100-265V	120°/60°	2800-6500K	≥70
KH-SL-S076-30W-B-SMD	30W	340*125*48mm	30pcs	SMD 3030	3000lm	AC100-265V	120°/60°	2800-6500K	≥70
KH-SL-S076-50W-B-SMD	50W	390*147*60mm	60pcs	SMD 3030	5000lm	AC100-265V	120°/60°	2800-6500K	≥70
KH-SL-S076-100W-B-SMD	100W	452*171*60mm	100pcs	SMD 3030	10000lm	AC100-265V	120°/60°	2800-6500K	≥70

Model	Power	Size	Chip qty	Chip size	Lumen	Voltage	Beam Angle	CCT	CRI
KH-SL-S077-20W-B-SMD	20W	315*128*76mm	20pcs	SMD 3030	2000lm	AC100-265V	120°/60°	2800-6500K	≥70
KH-SL-S077-30W-B-SMD	30W	351*142*76mm	30pcs	SMD 3030	3000lm	AC100-265V	120°/60°	2800-6500K	≥70
KH-SL-S077-50W-B-SMD	50W	405*166*79mm	60pcs	SMD 3030	5000lm	AC100-265V	120°/60°	2800-6500K	≥70
KH-SL-S077-100W-B-SMD	100W	484*211*83mm	100pcs	SMD 3030	10000lm	AC100-265V	120°/60°	2800-6500K	≥70
KH-SL-S077-120W-B-SMD	120W	484*211*83mm	120pcs	SMD 3030	12000lm	AC100-265V	120°/60°	2800-6500K	≥70
KH-SL-S077-150W-B-SMD	150W	580*242*83mm	180pcs	SMD 3030	15000lm	AC100-265V	120°/60°	2800-6500K	≥70
KH-SL-S077-200W-B-SMD	200W	580*242*83mm	240pcs	SMD 3030	20000lm	AC100-265V	120°/60°	2800-6500K	≥70
KH-SL-S077-250W-B-SMD	250W	580*242*83mm	250pcs	SMD 3030	24000lm	AC100-265V	120°/60°	2800-6500K	≥70

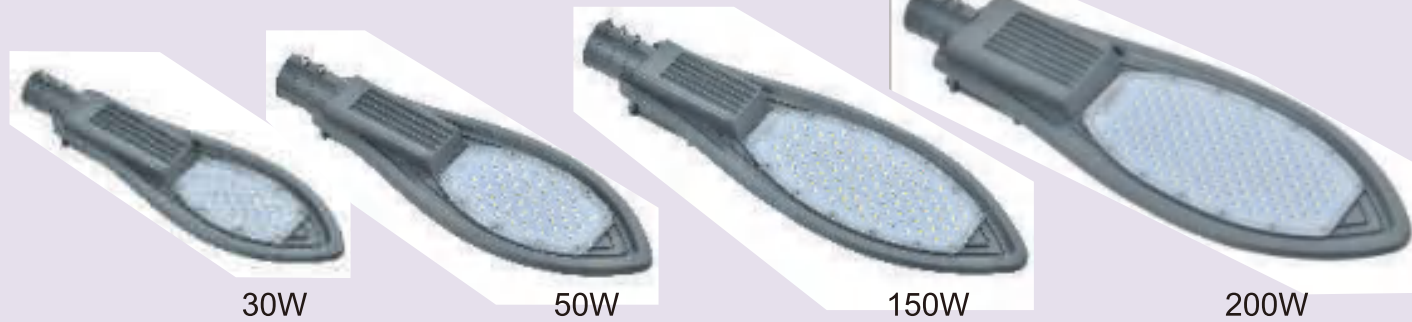
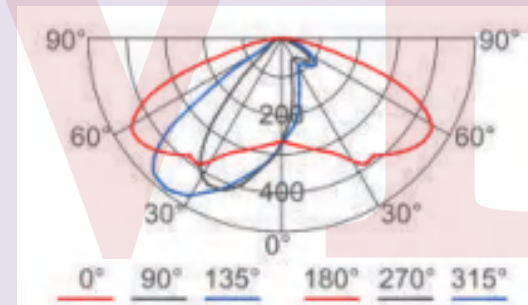
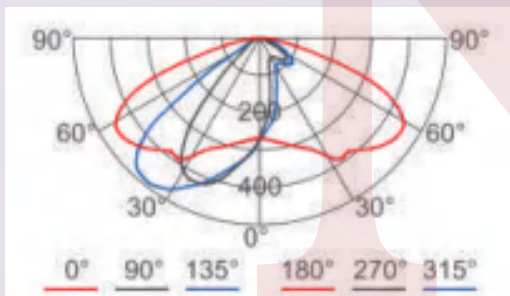

IP65 CE IK08 LED

IP65 CE IK08 LED

Model	Power	Size	Chip qty	Chip size	Lumen	Voltage	Beam Angle	CCT	CRI
KH-SL-S048-30W-G-SMD	30W	495*170*55mm	35pcs	3030	3000lm	AC100-277V	120*60°	2800-6500K	≥70
KH-SL-S048-50W-G-SMD	50W	540*195*60mm	55pcs	3030	5000lm	AC100-277V	120*60°	2800-6500K	≥70
KH-SL-S048-100W-G-SMD	100W	700*245*90mm	110pcs	3030	10000lm	AC100-277V	120*60°	2800-6500K	≥70
KH-SL-S048-150W-G-SMD	150W	772*280*90mm	165pcs	3030	15000lm	AC100-277V	120*60°	2800-6500K	≥70
KH-SL-S048-200W-G-SMD	200W	772*280*90mm	220pcs	3030	20000lm	AC100-277V	120*60°	2800-6500K	≥70
KH-SL-S048-240W-G-SMD	240W	772*280*90mm	250pcs	3030	25000lm	AC100-277V	120*60°	2800-6500K	≥70

Model	Power	Size	Chip qty	Chip size	Lumen	Voltage	Beam Angle	CCT	CRI
KH-SL-S048-30W-G-MCOB	30W	350*150*55mm	30pcs	3030	3000lm	AC100-277V	145*90°	2800-6500K	≥70
KH-SL-S048-50W-G-MCOB	50W	500*212*63mm	45pcs	3030	5000lm	AC100-277V	145*90°	2800-6500K	≥70
KH-SL-S048-100W-G-MCOB	100W	725*280*80mm	90pcs	3030	10000lm	AC100-277V	145*90°	2800-6500K	≥70
KH-SL-S048-150W-G-MCOB	150W	855*330*83mm	135pcs	3030	15000lm	AC100-277V	145*90°	2800-6500K	≥70
KH-SL-S048-200W-G-MCOB	200W	950*355*87mm	180pcs	3030	20000lm	AC100-277V	145*90°	2800-6500K	≥70
KH-SL-S048-250W-G-MCOB	250W	1100*335*80mm	225pcs	3030	25000lm	AC100-277V	145*90°	2800-6500K	≥70

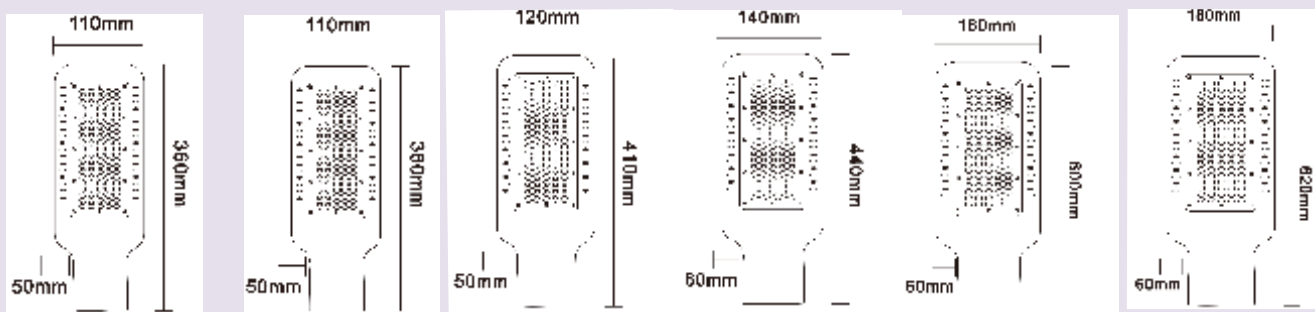
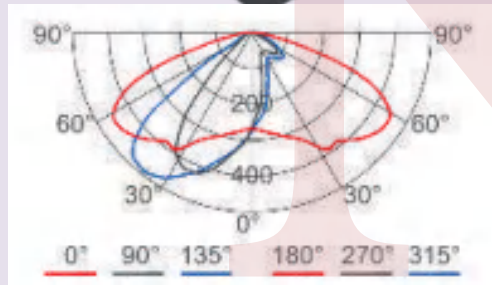

IP65 CE IK08 LED

Model	Power	Size	Chip qty	Chip size	Lumen	Voltage	Beam Angle	CCT	CRI
KH-SL-S050-20W-B-SMD	20W	280*110*40mm	20pcs	3030	2000lm	AC100-277V	120°*60°	2800-6500K	≥70
KH-SL-S050-30W-B-SMD	30W	310*125*40mm	30pcs	3030	3000lm	AC100-277V	120°*60°	2800-6500K	≥70
KH-SL-S050-50W-B-SMD	50W	400*180*50mm	50pcs	3030	5000lm	AC100-277V	120°*60°	2800-6500K	≥70
KH-SL-S050-100W-B-SMD	100W	528*180*50mm	100pcs	3030	10000lm	AC100-277V	120°*60°	2800-6500K	≥70
KH-SL-S050-150W-B-SMD	150W	630*195*65mm	150pcs	3030	15000lm	AC100-277V	120°*60°	2800-6500K	≥70
KH-SL-S050-200W-B-SMD	200W	650*200*50mm	200pcs	3030	20000lm	AC100-277V	120°*60°	2800-6500K	≥70



Pole Connectors:

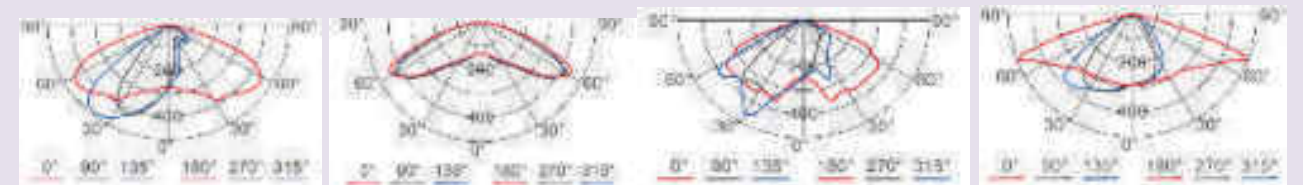
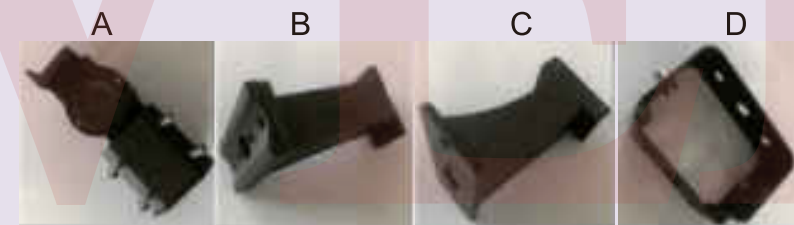

IP65 CE IK08 LED

Model	Power	Size	Chip qty	Chip size	Lumen	Voltage	Beam Angle	CCT	CRI
KH-SL-S052-100W-B-SMD	100W	495*310*84mm	108	3030	13000lm	AC100-277V	T1/T2/T3/T4/T5	2800-6500K	>70
KH-SL-S052-200W-B-SMD	100W	621*310*84mm	216	3030	26000lm	AC100-277V	T1/T2/T3/T4/T5	2800-6500K	>70
KH-SL-S052-300W-B-SMD	300W	769*320*84mm	324	3030	39000lm	AC100-277V	T1/T2/T3/T4/T5	2800-6500K	>70

PHILIPS

PHILIPS

5 Years Warranty

5 Years Warranty

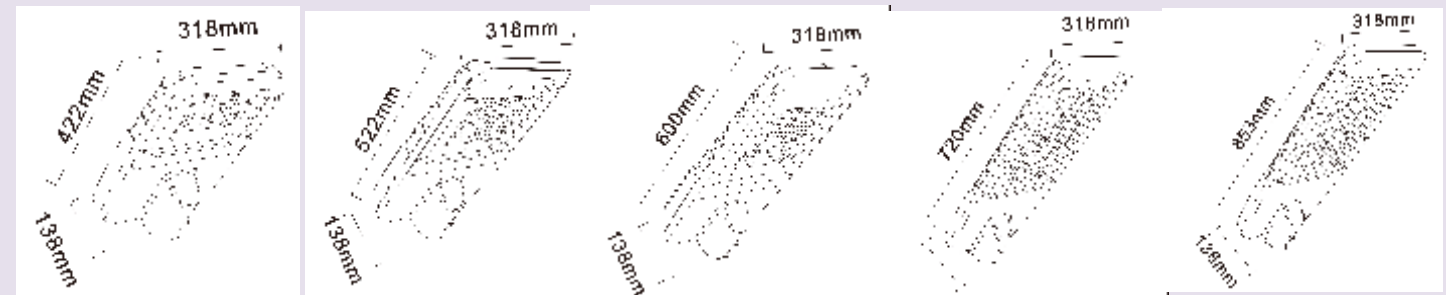
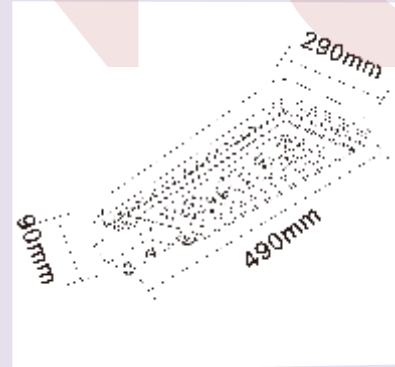
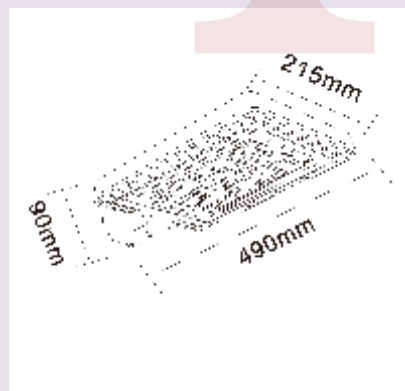
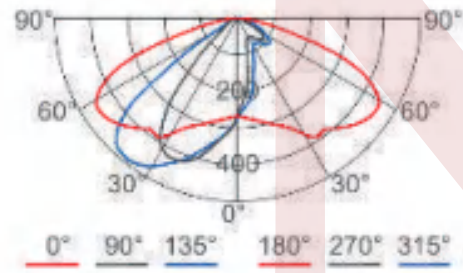

IP65 CE IK08 LED

IP65 CE IK08 LED

Model	Power	Size	Chip qty	Chip size	Lumen	Voltage	Beam Angle	CCT	CRI
KH-SL-S053-90W-B-SMD	90W	490*215*90mm	90	3030	9900lm	AC100-277V	T2	2800-6500K	>70
KH-SL-S053-150W-B-SMD	150W	490*290*90mm	180	3030	16500lm	AC100-277V	T2	2800-6500K	>70
KH-SL-S053-300W-B-SMD	300W	870*290*90mm	380	3030	33000lm	AC100-277V	T2	2800-6500K	>70

Model	Power	Size	Chip qty	Chip size	Lumen	Voltage	Beam Angle	CCT	CRI
KH-SL-S054-100W-B-SMD	100W	422*318*138mm	96	3030	11000lm	AC100-277V	T2	2800-6500K	>70
KH-SL-S054-150W-B-SMD	150W	522*318*138mm	144	3030	16500lm	AC100-277V	T2	2800-6500K	>70
KH-SL-S054-180W-B-SMD	180W	600*318*138mm	192	3030	19800lm	AC100-277V	T2	2800-6500K	>70
KH-SL-S054-240W-B-SMD	240W	720*318*138mm	288	3030	26400lm	AC100-277V	T2	2800-6500K	>70
KH-SL-S054-300W-B-SMD	300W	853*318*138mm	384	3030	33000lm	AC100-277V	T2	2800-6500K	>70

Slip-joint version

KH-POL-DX-Jointed series

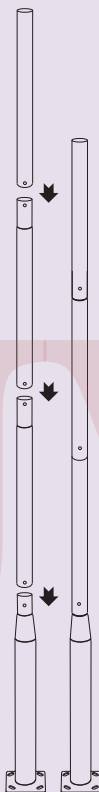

PRODUCT PARAMETERS

Specification		Height	Package size
Top diameter	Φ76	2.5m	113x24x23cm
Bottom pole	Φ114	3m	
Base Flange	250*250	4m	
Material	galvanized pipe	5m	
Anchor Bolt	160*160*14*300H		

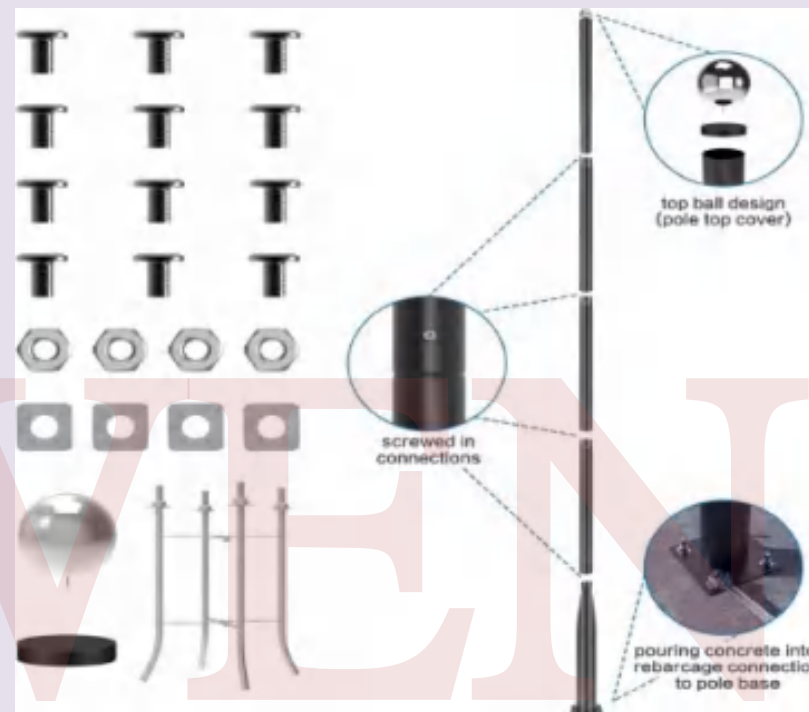



STREET POLE

Single piece version



KH-POL-DX-Single series



PRODUCT PARAMETERS

Specification		Height	Package size
Top diameter	Φ 76mm	2.5m	
Bottom pole	Φ 114mm	3m	
Base Flange	250*250 mm	4m	
Material	galvanized pipe	5m	
Anchor Bolt	160*160*14*300H		



STREET POLE

Single piece straight version



KH-POL-ST-Single series



PRODUCT PARAMETERS

Specification		Height	Package size
diameter	Φ 76	2.5m/3m/4m/5m	
Base Flange	250*250 mm		
Material	galvanized pipe		
Anchor Bolt	160*160*14*300H		

+86-18680577977